Federal Communications Commission (F.C.C) Statement

This device complies with Part 15 of the FCC Rules. Operation of this device is subject to the following two conditions: (1) this device may not cause harmful interference, and (2) this device must accept any interference received, including interference that may cause undesired operation.

Accessories: This device has been tested and found to comply with the limits of a Class B digital device, the accessories associated with this equipment are as follows:

1. Shielded serial cable. (Can be obtained from multiple retail outlets)
2. Shielded printer cable. (Can be obtained from multiple retail outlets)
3. Shielded video cable. (Can be obtained from multiple retail outlets)
4. Shielded power cord. (Provided by manufacturer)

These accessories are required to ensure compliance with FCC Rules. It is the responsibility of the user to provide and use these accessories properly.

This equipment has been tested and found to comply with the limits of a Class B digital device, pursuant to Part 15 of the FCC Rules. These limits are designed to provide reasonable protection against harmful interference in a residential installation. This equipment generates, uses and can radiate radio frequency energy and, if not installed and used in accordance with the instructions, may cause harmful interference to radio communications. There is no guarantee that interference will not occur in a particular installation. If this equipment does cause harmful interference to radio or television reception, which can be determined by turning the equipment off and on, you are encouraged to try to correct the interference by one or more of the following measures:

1. Reorient / relocate the receiving antenna.
2. Increase the separation between the equipment and receiver.
3. Connect the equipment into an outlet on a circuit different from that to which the receiver is connected.
4. Consult the dealer or an experienced radio/TV technician for help.

Caution: Changes or modifications not expressly approved by the

manufacturer could void the user's authority to operate the equipment.

Disclaimer

The vendor makes no representations or warranties with respect to the contents here of and specially disclaims any implied warranties of merchantability or fitness for any purpose. Further the vendor reserves the right to revise this publication and to make changes to the contents here of without obligation to notify any party beforehand.

Duplication of this publication, in part or in whole, is not allowed without first obtaining the vendor's approval in writing.

Trademarks and Remarks

MS-DOS, Windows NT, Windows 9X, Windows 2000 and Windows ME are products of Microsoft Corp, with its ownership of trademark, and are distributed by the vendor under a license agreement.

All trademarks used in this manual are the property of their respective owners.

Copyright© 2001

All Rights Reserved

Canadian D.O.C. Statement

This digital apparatus does not exceed the Class B limits for radio noise emissions from digital apparatus as set out in the radio interference regulations of the Canadian Department of Communications.

Cet appareil numérique n'émet pas de bruits radioélectriques dépassant les limites appliquées aux appareils numériques de Class B prescrits dans le règlement du brouillage radioélectrique edict par le minister Des Communications du Canada.

Contents

Introduction	1-1
1. Motherboard Description	1-2
1.1 Features	1-2
1.1.1 Hardware	1-2
1.1.2 Software	1-5
1.1.3 Attachments.....	1-5
1.2 Motherboard Installation.....	1-6
1.2.1 Layout of Motherboard	1-6
1.3 Motherboard Quick Reference	1-7
1.3.1 Front Panel Headers (JPANEL1 / JPANEL2).....	1-8
1.3.2 Floppy Disk Connector (FDD1).....	1-10
1.3.3 Hard Disk Connectors (IDE1/IDE2)	1-10
1.3.4 ATX 20-pin Power Connector (JATXPWR1).....	1-11
1.4 Back Panel Connectors	1-12
1.4.1 PS/2 Mouse / Keyboard CONN.: JKBMS1	1-12
1.4.2 USB Connector: JUSB1	1-13
1.4.3 Monitor Connector: JVGA1	1-14
1.4.4 Front USB Header: JUSB2	1-15
1.5 Serial and Parallel Interface Ports	1-16
1.6 CPU Installation.....	1-19
1.6.1 CPU Installation Procedure: Socket A	1-19
1.6.2 CPU Jumper Settings (Optional)	1-20

Contents

1.6.2.1 CPU Frequency Selection: JCLK1	1-21
1.6.2.2 CPU Ratio Selection: JCLK2	1-21
1.7 Jumper Settings	1-22
1.7.1 CPU Fan Header: JCFAN1	1-23
1.7.2 System Fan Header: JSFAN1	1-23
1.7.3 System Fan Header: JSFAN3 (Optional)	1-23
1.7.4 Wake-On MODEM Header: JWOM1 (Optional)	1-23
1.7.5 Wake-On-LAN Header: JWOL1	1-24
1.7.6 CMOS Function Selection: JCMOS1	1-24
1.8 DRAM Installation.....	1-25
1.8.1 DIMM	1-25
1.8.2 How to install a DIMM Module.....	1-26
1.9 Audio Subsystem.....	1-27
1.9.1 CD Audio-In Headers: JCDIN1/JCDIN2.....	1-28
1.9.2 Telephony Header: JTAD1	1-28
1.9.3 AUX Audio in Connector: JAUX1 (Optional).....	1-28
1.9.4 Front Audio Header: JF_AUDIO (Optional).....	1-29
2. BIOS Setup.....	2-1
2.1 Main Menu.....	2-3
2.2 Standard CMOS Features.....	2-5
2.3 Advanced BIOS Features.....	2-8
2.4 Advanced Chipset Features.....	2-12
2.5 Integrated Peripherals	2-17

Contents

2.6 Power Management Setup.....	2-22
2.7 PnP/PCI Configurations.....	2-27
2.8 PC Health Status	2-30
2.9 Frequency/Voltage Control.....	2-31
2.10 Load Fail-Safe Defaults	2-32
2.11 Load Optimized Defaults	2-33
2.12 Set Supervisor / User Password	2-34
2.13 Save & Exit Setup	2-36
2.14 Exit Without Saving.....	2-37
3. Software Setup	3-1
3.1 Software List.....	3-1
3.2 Software Installation	3-2
3.3 Using Software.....	3-4
4. Trouble Shooting	4-1

Introduction

System Overview

Thanks for buying this product! This manual was written to help you start using this product as quickly and smoothly as possible. Inside you will find adequate explanations to solve most problems. In order for this reference material to be of greatest use, refer to the “expanded table of contents” to find relevant topics.

This board incorporates the system board, I/O, and PCI IDE into one board that provides a total PC solution. The mainboard, a AMD Athlon™ and Duron™ processor based PC Micro ATX system, supports single processors with PCI Local Bus, and AGP Bus to support upgrades to your system performance. It is ideal for multi-tasking and fully supports MS-DOS, Windows NT, Windows 2000, Novell, Windows95/98, Windows ME, UNIX, SCO UNIX etc. This manual also explains how to install the mainboard for operation, and how to setup your CMOS configuration with the BIOS setup program.

1. Motherboard Description

1.1 Features

1.1.1 Hardware

CPU

- Single AMD Socket-A for Athlon™ (Thunderbird™) / Duron™ processor Module-500MHz ~ 1GHz.
- 200/266 MHz Front Side Bus (FSB).
(Note: Chipset VT8364 for CPU 200 FSB only,
Chipset VT8364A for CPU 200/266 FSB)

Speed

- Support 33MHz PCI Bus speed.

DRAM Memory

- Supports 8/16/32/64/128/256MB DIMM module socket.
- Supports Synchronous DRAM (3.3V).
- Support a maximum memory size of 512MB with SDRAM.

Shadow RAM

- A memory controller provide shadow RAM and supports 8-bit ROM BIOS.

Green Function

- Support power management operation via BIOS.
- Power down timer from 1 to 15 mins.
- Wakes from power saving sleep mode at the press of any key or any mouse activity.

BUS Slots

- Three 32-bit PCI bus master slots.
- Provides CNR (Modem function only) slot . The CNR slot only support the secondary codec on the CNR slot.

Flash Memory

- Supports flash memory.
- Supports ESCD Function.

IDE Built-in On Board

- Supports four IDE hard disk drives.
- Supports PIO Mode 4, Master Mode, high performance hard disk drives.
- Supports Ultra DMA 33/ 66/ 100 (Optional) Bus Master Mode.
- Supports IDE interface with CD-ROM.
- Supports high capacity hard disk drives.
- Supports LBA mode.

Stereo AC 97 Digital Audio Codec

- AC 97 2.1 interface.
- 16 channels of high-quality sample rate conversion.
- 16x8 channel digital mixer.
- Stereo 10 band graphic equalizer.
- Sound Blaster® and Sound Blaster Pro® emulation.
- 64-voice wavetable.
- PC99 complaint and WHQL certified.

I/O Built-in On Board

- Supports one multi-mode Parallel Port.
 - (1) Standard & Bidirection Parallel Port.
 - (2) Enhanced Parallel Port (EPP).
 - (3) Extended Capabilities Port (ECP).
- Supports one serial port, 16550 UART.
- Supports one Infrared transmission (IR).
- Supports PS/2 mouse and PS/2 keyboard.
- Supports 360KB, 720KB, 1.2MB, 1.44MB, and 2.88MB floppy disk drivers.

Universal Serial Bus

- Supports two back Universal Serial Bus (USB) Ports and two front Universal serial Bus (USB) Ports (Optional).
- Supports 48 MHz USB.

Hardware Monitor Function

- CPU Fan Speed Monitor.
- System and CPU Temperature Monitor (Optional).
- System Voltage Monitor.

Dimensions (Micro ATX)

- 22.2 cm X 24.4 cm (W x L)

Integrated Savage4 2D/3D/Video Accelerator

- Optimized Shared Memory Architecture (SMA).
- 2 to 32 MB frame buffer using system memory.
- Floating point triangle setup engine.
- Single cycle 128-bit 3D architecture.
- 8M triangles/second setup engine.
- 140M pixels/second trilinear fill rate.
- Full AGP 4x, including sideband addressing and execute mode.
- S3 DX6 texture compression (S3TC).
- Next generation, 128-bit 2D graphics engine.
- High quality DVD video playback.
- Flat panel monitor support.
- 2D/3D resolutions up to 1920x1440.

1.1.2 Software

BIOS

- AWARD legal BIOS.
- Supports APM1.2.
- Supports USB Function.
- Supports ACPI.

Operating System

- Offers the highest performance for MS-DOS, Windows NT, Windows 2000, Windows 95/98, Windows ME, Novell, UNIX, SCO UNIX etc.

1.1.3 Attachments

- HDD Cable.
- FDD Cable.
- Flash Memory Writer for BIOS Update.
- USB2 Cable (Optional).
- Rear I/O Panel for ATX Case (Optional).
- Fully Setup Driver CD.



For 1.2GHz CPU, we recommend the user to add a "Chipset Fan" in order to reduce the excess thermal dissipated from Northbridge Chipset.

1.2 Motherboard Installation

1.2.1 Layout of Motherboard

Model No.M7VKL

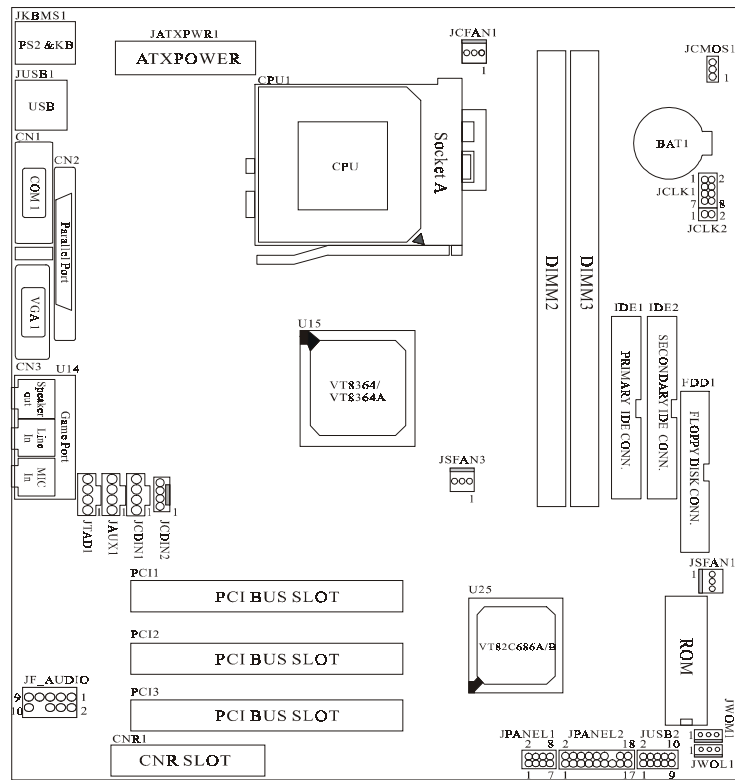

1.3 Motherboard Quick Reference

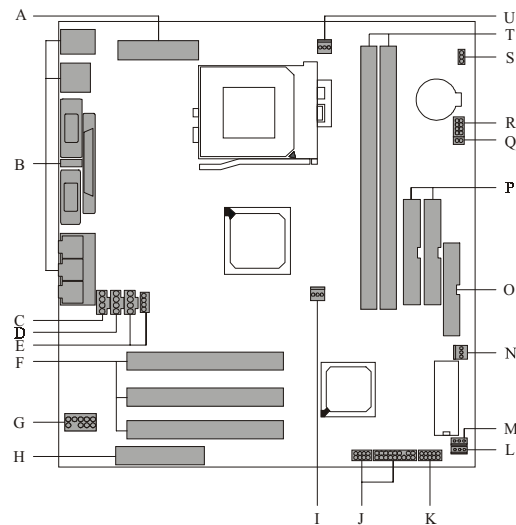

- | | |
|--|--|
| A. ATX Power Connector (JATXPWR1) | L. Wake-On-LAN Header (JWOL1) |
| B. Back Panel I/O Connectors | M. Wake-On MODEM Header (JWOM1*) |
| C. Telephony Header (JTAD1) | N. System Fan Connector (JSFAN1) |
| D. AUX Audio-In Header (JAUX1*) | O. FDD Connector (FDD1) |
| E. CD Audio-In Header (JCDIN1-2) | P. IDE Connectors (IDE1-2) |
| F. PCI BUS Slots (PCI1-3) | Q. CPU Ratio Selection (JCLK2*) |
| G. Front Audio Header (JF_AUDIO) | R. CPU Frequency Selection (JCLK1*) |
| H. CNR Slot (CNR1) | S. CMOS Function Selection (JCMOS1) |
| I. Chipset Fan Header (JSFAN3*) | T. DIMMs (DIMM2-3) |
| J. Front Panel Header (JPANEL1-2) | U. CPU Fan Header (JCFAN1) |
| K. Front USB Header (JUSB2) | |

NOTE: The “*” mark represent the function is optional.

1.3.1 Front Panel Headers (JPANEL1 / JPANEL2)

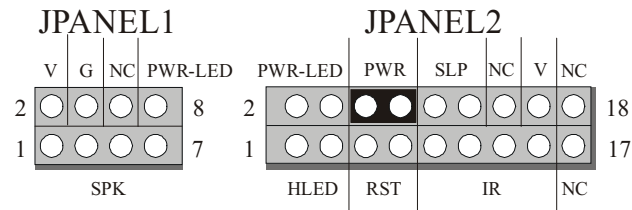

JPANEL1

Pin No.	Assignment	Function	Pin No.	Assignment	Function
1	+5V	Speaker Connector	2	+5V	VCC
3	No Connection		4	Ground	Ground
5	Ground		6	No Connection	No Connection
7	Speaker		8	Power LED(-)	PWR LED

JPANEL2

Pin No.	Assignment	Function	Pin No.	Assignment	Function
1	HDD LED (+)	Hard Drive LED	2	Power LED (-)	PWR LED
3	HDD LED (-)		4	Power LED (+)	
5	Ground	Reset Button	6	Power Button	ATX Power Button
7	Reset Control		8	Ground	
9	+5V	IrDA Connector	10	Sleep Control	SLP Button
11	Ir-In		12	Ground	
13	Ground		14	No Connection	No Connection
15	Ir-Out		16	+5V	VCC
17	No Connection	No Connection	18	No Connection	No Connection

Speaker Connector

An offboard speaker can be installed on the motherboard as a manufacturing option. An offboard speaker can be connected to the motherboard at the front panel connector. The speaker (onboard or offboard) provides error beep code information during the Power On Self-Test when the computer cannot use the video interface. The speaker is not connected to the audio subsystem and does not receive output from the audio subsystem.

Reset Button

This connector can be connected to a momentary SPST type switch that is normally open. When the switch is closed, the motherboard resets and runs the POST.

Power LED Connector

This connector can be connected to an LED that will light when the computer is powered on.

Hard Drive LED Connector

This connector can be connected to an LED to provide a visual indicator that data is being read from or written to a hard drive. For the LED to function properly, an IDE drive must be connected to the onboard hard drive controller.

Infrared Connector

After the IrDA interface is configured, files can be transferred from or to portable devices such as laptops, PDAs, and printers using application software.

Sleep Button

When APM is enabled in the system BIOS, and the operating system's APM driver is loaded, the system can enter sleep (standby) mode in one of the following ways:

- **Optional front panel SMI button**
- **Prolonged system inactivity using the BIOS inactivity timer feature**

The 2-pin header located on the front panel I/O connector supports a front panel SMI switch, which must be a momentary SPST type that is normally open.

Closing the SMI switch sends a System Management Interrupt (SMI) to the processor, which immediately goes into System Management Mode (SMM). While the computer is in sleep mode it is fully capable of responding to and servicing external interrupts (such as an incoming fax) even though the monitor turns on only if a keyboard or mouse interrupt occurs. To reactivate or resume the system, the SMI switch must be pressed again, or the keyboard or mouse must be used.

Power On Button

This connector can be connected to a front panel power switch. The switch must pull the Power Button pin to ground for at least 50 ms to signal the power supply to switch on or off. (The time requirement is due to internal debounce circuitry on the motherboard). At least two seconds must pass before the power supply will recognize another on/off signal.

1.3.2 Floppy Disk Connector (FDD1)

The motherboard provides a standard floppy disk connector (FDC) that supports 360K, 720K, 1.2M, 1.44M and 2.88M floppy disk types. This connector supports the provided floppy drive ribbon cables.

1.3.3 Hard Disk Connectors (IDE1/IDE2)

The motherboard has a 32-bit Enhanced PCI IDE Controller that provides PIO Mode 0~4, Bus Master, and Ultra DMA / 33, Ultra DMA / 66, Ultra DMA / 100 (optional) functionality. It has two HDD connectors IDE1 (primary) and IDE2 (secondary). You can connect up to four hard disk drives, a CD-ROM, a 120MB Floppy (reserved for future BIOS) and other devices to IDE1 and IDE2. These connectors support the IDE hard disk cable provided.

- **IDE1 (Primary IDE Connector)**

The first hard drive should always be connected to IDE1. IDE1 can connect a Master and a Slave drive. You must configure the second hard drive on IDE1 to Slave mode by setting the jumper accordingly.

- **IDE2 (Secondary IDE Connector)**

The IDE2 controller can also support a Master and a Slave drive. The configuration is similar to IDE1. The second drive on this controller must be set to slave mode.

1.3.4 ATX 20-pin Power Connector (JATXPWR1)

This connector supports the power button on-board. Using the ATX power supply, functions such as Modem Ring Wake-Up and Soft Power Off are supported on this motherboard. This power connector supports instant power-on functionality, which means that the system will boot up instantly when the power connector is inserted on the board.

Pin No.	Assignment	Pin No.	Assignment
1	+3.3V	11	+3.3V
2	+3.3V	12	-12V
3	Ground	13	Ground
4	+5V	14	PS_ON
5	Ground	15	Ground
6	+5V	16	Ground
7	Ground	17	Ground
8	PW_OK	18	-5V
9	5V_SB	19	+5V
10	+12V	20	+5V

1.4 Back Panel Connectors

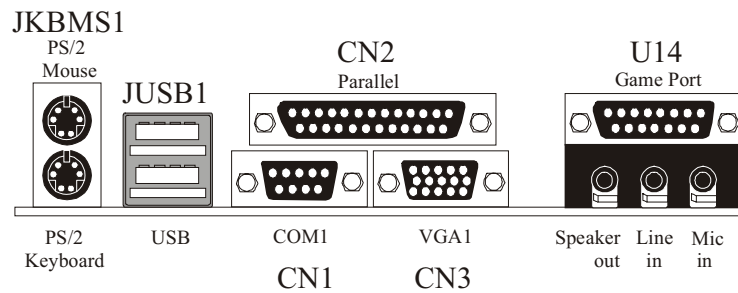

1.4.1 PS/2 Mouse / Keyboard CONN.: JKBMS1

The motherboard provides a standard PS/2 mouse / Keyboard mini DIN connector for attaching a PS/2 mouse. You can plug a PS/2 mouse / Keyboard directly into this connector. The connector location and pin definition are shown below:

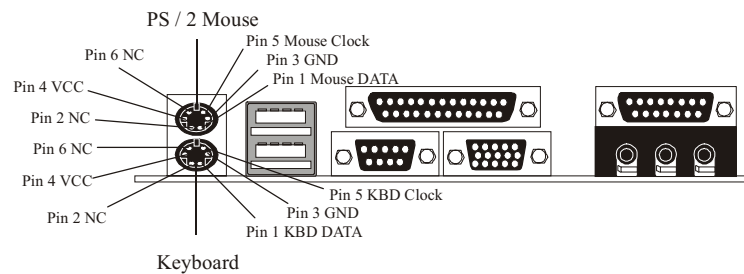

PS/2 Mouse / Keyboard Connectors

Pin No.	Signal Name
1	Data
2	No connection
3	Ground
4	+5 V (fused)
5	Clock
6	No connection

1.4.2 USB Connector: JUSB1

The motherboard provides a **OHCI (Open Host Controller Interface) Universal Serial Bus Roots** for attaching USB devices such as: keyboard, mouse and other USB device.

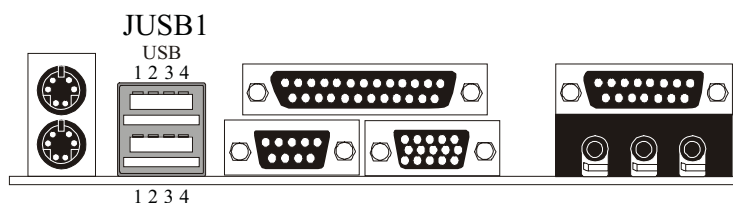
**Stacked USB Connectors**

Pin No.	Assignment
1	+5 V
2	USBP0- [USBP1-]
3	USBP0+ [USBP1+]
4	Ground

Signal names in brackets ([]) are for USB Port 1.

1.4.3 Monitor Connector: JVGA1

This motherboard has built in video facilities. Your monitor will attach directly to JVGA1 connector on the motherboard.

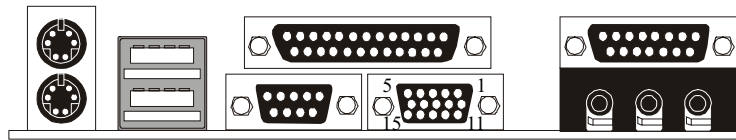

JVGA1

Pin No.	Assignment	Pin No.	Assignment
1	Red	2	Green
3	Blue	4	+5V
5	Ground	6	Ground
7	Ground	8	Ground
9	+5V	10	Ground
11	+5V	12	DDC/Data
13	HSYNC	14	VSYNC
15	DDC/CLK		

1.4.4 Front USB Header: JUSB2

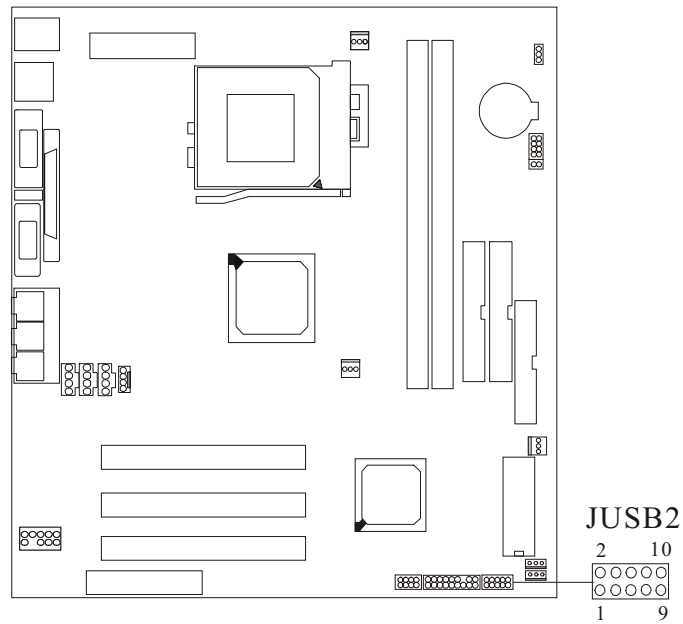

Pin No.	Signal Name	Pin No.	Signal Name
1	+5V	2	Ground
3	USBP2-	4	Ground
5	USBP2+	6	USBP3+
7	Ground	8	USBP3-
9	Ground	10	+5V

1.5 Serial and Parallel Interface Ports

This system comes equipped with one serial port and one parallel port. Both types of interface ports will be explained in this chapter.

The Serial Interface: CN1

The serial interface port is sometimes referred to as an RS-232 port or an asynchronous communication port. Mice, printers, modems and other peripheral devices can be connected to a serial port. The serial port can also be used to connect your computer with another computer system. If you wish to transfer the contents of your hard disk to another system it can be accomplished by using each machine's serial port.

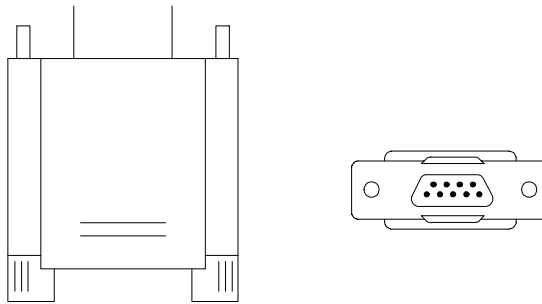

The serial port on this system has one 9-pin connector. Some older computer systems and peripherals used to be equipped with only one 25-pin connector. Should you need to connect your 9-pin serial port to an older 25-pin serial port, you can purchase a 9-to-25 pin adapter.

Connectivity

The serial port can be used in many ways, and it may be necessary to become familiar with the pinout diagram. The following chart gives you the function of each pin on the 9-pin connector and some of the 25-pin connector. This information can be used when configuring certain software programs to work with the serial port.

Signal	Name	DB9 PIN	DB25 PIN
DCD	Data Carrier Detect	1	8
RX	Receive Data	2	3
TX	Transmit Data	3	2
DTR	Data Terminal Ready	4	20
GND	Signal Ground	5	7
DSR	Data Set Ready	6	6
RTS	Request to Send	7	4
CTS	Clear to Send	8	5
RI	Ring Indicator	9	22

Parallel Interface Port : CN2

Unlike the serial port, parallel interface port has been standardized and should not present any difficulty interfacing peripherals to your system. Sometimes called Centronics port, the parallel port is almost exclusively used with printers. The parallel port on your system has a 25-pin, DB25 connector (see picture below). The pinouts for the parallel port are shown in the table below.

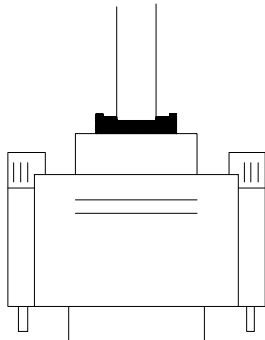
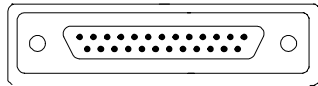

Signal	Pin
-Strobe	1
Data 0	2
Data 1	3
Data 2	4
Data 3	5
Data 4	6
Data 5	7
Data 6	8
Data 7	9
-Ack	10
Busy	11
Paper Empty	12
+Select	13
-Auto FDXT	14
-Error	15
-Init	16
-SLCTN	17
Ground	18
Ground	19
Ground	20
Ground	21
Ground	22
Ground	23
Ground	24
Ground	25

1.6 CPU Installation

1.6.1 CPU Installation Procedure: Socket A

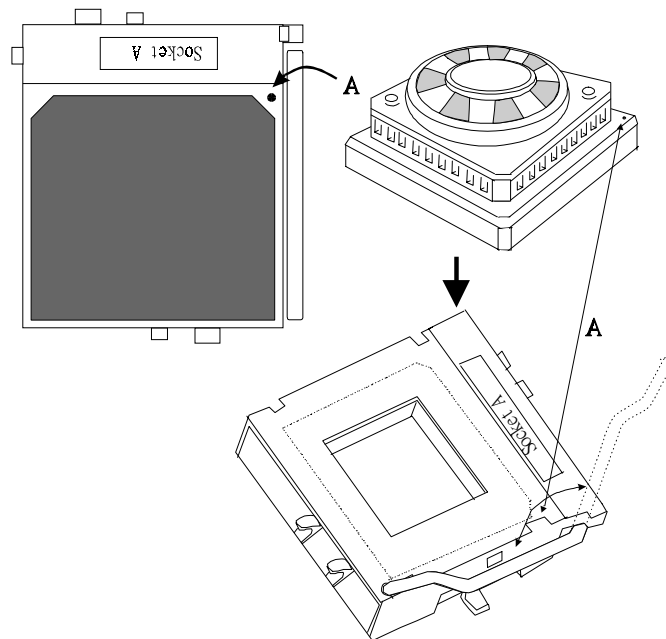

1. Pull the lever sideways away from the socket then raise the lever up to a 90-degree angle.
2. Locate Pin A in the socket and look for the white dot or cut edge in the CPU. Match Pin A with the white dot/cut edge then insert the CPU.
3. Press the lever down to complete the installation.

1.6.2 CPU Jumper Settings (Optional)

This motherboard produces a feature which can auto-detect the speed without jumper setting. Also, you can use the JCLK1 and JCLK2 jumpers to set the appropriately speed of CPU when the auto-detect function is disabled.

This section describes how to configure the CPU jumpers by manual to match the characteristics of the CPU you have installed on your motherboard.

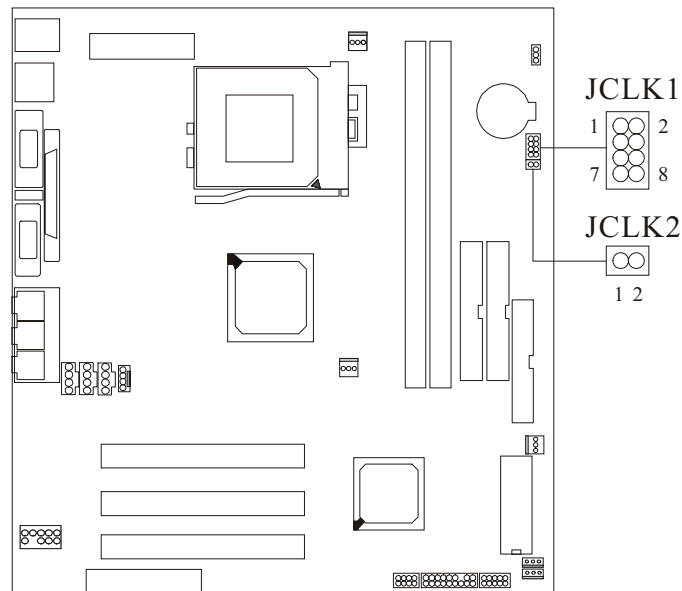

NOTES: *JCLK1 and JCLK2 tables is available by Hardware setting when BIOS setting is useless or disabled.*

1.6.2.1 CPU Frequency Selection: JCLK1**(For Chipset VT8364A only)**

JCLK1 FREQ.	1-2	3-4	5-6	7-8
*100MHz	OFF	OFF	OFF	OFF
133MHz	OFF	OFF	ON	OFF

1.6.2.2 CPU Ratio Selection: JCLK2**(For Chipset VT8364A only)**

CPU (MHz)	JCLK2
*100MHz	ON
133MHz	OFF

*NOTES: The “ * ” mark indicate primitive value.*

1.7 Jumper Settings

A jumper has two or more pins that can be covered by a plastic jumper cap, allowing you to select different system options.

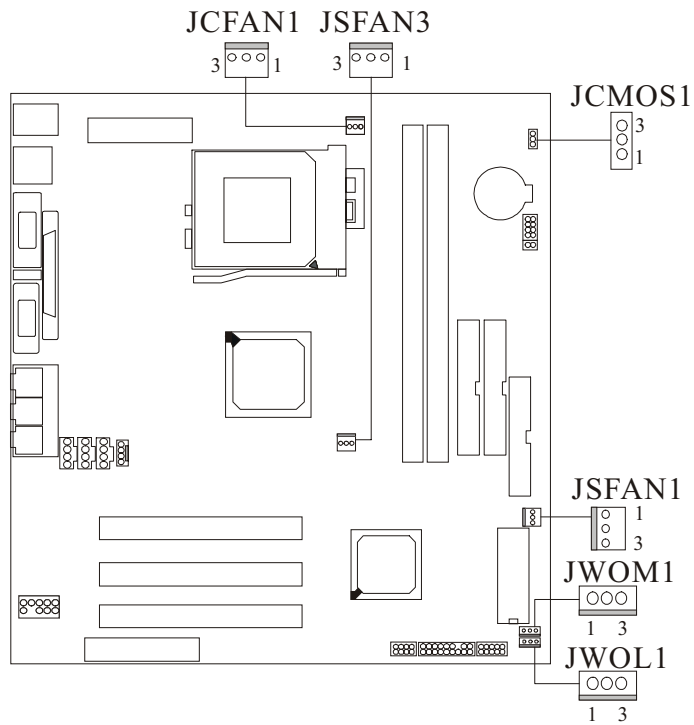

1.7.1 CPU Fan Header: JCFAN1

Pin No.	Assignment
1	Ground
2	+12V
3	Sense

1.7.2 System Fan Header: JSFAN1

Pin No.	Assignment
1	Ground
2	+12V
3	Sense

1.7.3 System Fan Header: JSFAN3 (Optional)

Pin No.	Assignment
1	Ground
2	+12V
3	Sense

1.7.4 Wake-On MODEM Header: JWOM1 (Optional)

Pin No.	Assignment
1	5V_SB
2	Ground
3	Wake-Up

1.7.5 Wake-On-LAN Header: JWOL1

Pin No.	Assignment
1	5V SB
2	Ground
3	Wake-up

1.7.6 CMOS Function Selection: JCMOS1

This jumper is set during the process of clearing BIOS configurations which may be necessary in certain circumstances (i.e. forgotten BIOS passwords)

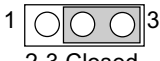
JCMOS1	Assignment
 1-2 Closed	Normal Operation (default)
 2-3 Closed	Clear CMOS Data



The following procedures are for resetting the BIOS password. It is important to follow these instructions closely.

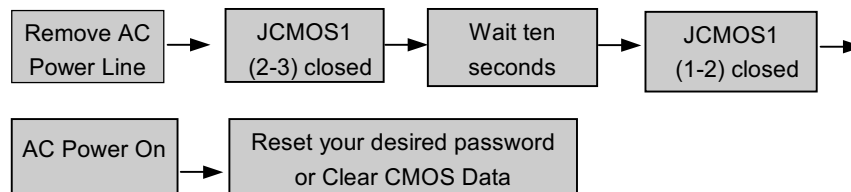

1.8 DRAM Installation

1.8.1 DIMM

DRAM Access Time : 3.3V Unbuffered SDRAM PC66/ PC100 and PC133 Type required.

DRAM Type : 8MB/ 16MB/ 32MB/ 64MB/ 128MB/ 256MB DIMM Module (168pin)

Total	Bank 0	Bank 1
Memory Size (MB)	DIMM2	DIMM3
8 M	8M x 1 pc	----
16 M	16M x 1 pc	----
32 M	32M x 1 pc	----
64 M	64M x 1 pc	----
128 M	128M x 1 pc	----
256 M	256M x 1 pc	----
16 M	8M x 1 pc	8M x 1 pc
32 M	16M x 1 pc	16M x 1 pc
64 M	32M x 1 pc	32M x 1 pc
128 M	64M x 1 pc	64M x 1 pc
256 M	128M x 1 pc	128M x 1 pc
512 M	256M x 1 pc	256M x 1 pc

*The list shown above for DRAM configuration is only for reference.

Note: Don't stuff or remove the DIMM memory, if the JS3-LED1 is lighting. (Optional)

1.8.2 How to install a DIMM Module

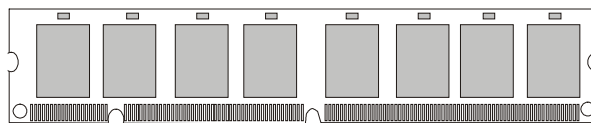

Single Sided DIMM

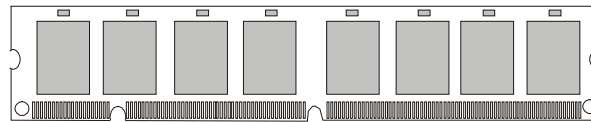

Double Sided DIMM

1. The DIMM socket has a “ Plastic Safety Tab” and the DIMM memory module has an asymmetrical notch”, so the DIMM memory module can only fit into the slot in one direction.

2. Push the tabs out. Insert the DIMM memory modules into the socket at a 90-degree angle then push down vertically so that it will fit into place.

3. The Mounting Holes and plastic tabs should fit over the edge and hold the DIMM memory modules in place.

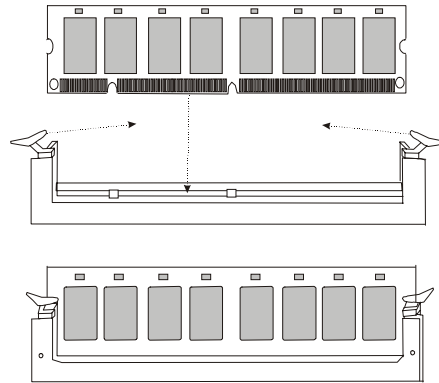

1.9 Audio Subsystem

Model No.M7VKL

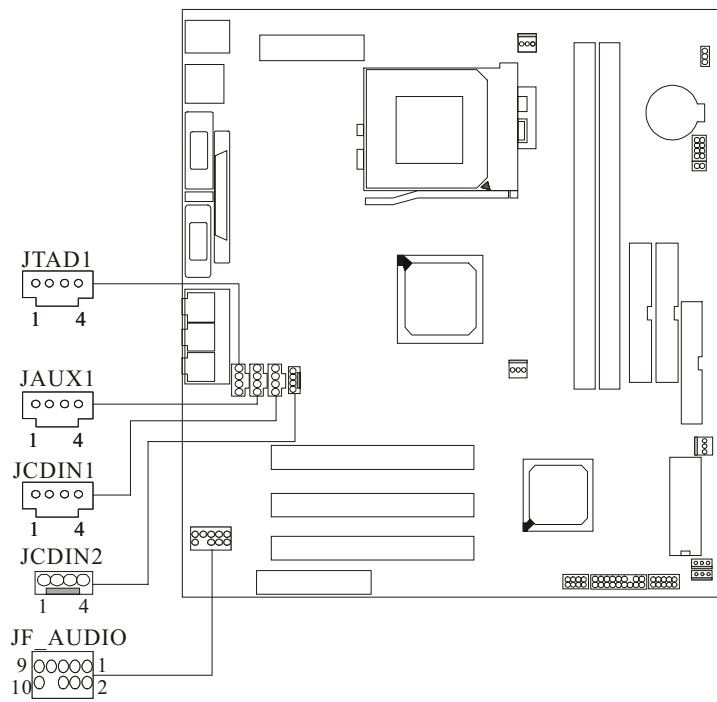

1.9.1 CD Audio-In Headers: JCDIN1/JCDIN2

Pin No. of JCDIN1	Assignment
1	Left Channel Input
2	Ground
3	Ground
4	Right Channel Input

Pin No. of JCDIN2	Assignment
1	Left Channel Input
2	Ground
3	Right Channel Input
4	Ground

1.9.2 Telephony Header: JTAD1

Pin No.	TAD
1	MONO_IN
2	Ground
3	Ground
4	MONO_OUT

1.9.3 AUX Audio in Connector: JAUX1 (Optional)

Pin No.	Signal Name
1	Left channel AUX_IN
2	Ground
3	Ground
4	Right channel AUX_IN

1.9.4 Front Audio Header: JF_AUDIO (Optional)

Pin No.	Signal Name
1	AUD_MIC
2	AUD_GND
3	AUD_MIC_BIAS
4	AUD_VCC
5	AUD_FPOUT_R
6	AUD_RET_R
7	HP_ON
8	KEY
9	AUD_FPOUT_L
10	AUD_RET_L

2. BIOS Setup

Introduction

This manual discussed Award™ Setup program built into the ROM BIOS. The Setup program allows users to modify the basic system configuration. This special information is then stored in battery-backed RAM so that it retains the Setup information when the power is turned off.

The Award BIOS™ installed in your computer system's ROM (Read Only Memory) is a custom version of an industry standard BIOS. This means that it supports AMD-Athlon™ / Duron™ processors input/output system. The BIOS provides critical low-level support for standard devices such as disk drives and serial and parallel ports.

Adding important has customized the Award BIOS™, but nonstandard, features such as virus and password protection as well as special support for detailed fine-tuning of the chipset controlling the entire system.

The rest of this manual is intended to guide you through the process of configuring your system using Setup.

Plug and Play Support

These AWARD BIOS supports the Plug and Play Version 1.0A specification. ESCD (Extended System Configuration Data) write is supported.

EPA Green PC Support

This AWARD BIOS supports Version 1.03 of the EPA Green PC specification.

APM Support

These AWARD BIOS supports Version 1.1&1.2 of the Advanced Power Management (APM) specification. Power management features are implemented via the System Management Interrupt (SMI). Sleep and Suspend power management modes are supported. Power to the hard disk drives and video monitors can be managed by this AWARD BIOS.

PCI Bus Support

This AWARD BIOS also supports Version 2.1 of the Intel PCI (Peripheral Component Interconnect) local bus specification.

DRAM Support

SDRAM (Synchronous DRAM) are supported.

Supported CPUs

This AWARD BIOS supports the AMD Athlon™ / Duron™ CPU.

Using Setup

In general, you use the arrow keys to highlight items, press <Enter> to select, use the <PgUp> and <PgDn> keys to change entries, press <F1> for help and press <Esc> to quit. The following table provides more detail about how to navigate in the Setup program by using the keyboard.

Keystroke	Function
Up arrow	Move to previous item
Down arrow	Move to next item
Left arrow	Move to the item on the left (menu bar)
Right arrow	Move to the item on the right (menu bar)
Esc	Main Menu: Quit without saving changes Submenus: Exit Current page to the next higher level menu
Move Enter	Move to the item you desired
PgUp key	Increase the numeric value or make changes
PgDn key	Decrease the numeric value or make changes
+ Key	Increase the numeric value or make changes
- Key	Decrease the numeric value or make changes
Esc key	Main Menu – Quit and not save changes into CMOS Status Page Setup Menu and Option Page Setup Menu – Exit Current page and return to Main Menu
F1 key	General help on Setup navigation keys
F5 key	Load previous values from CMOS
F6 key	Load the fail-safe defaults from BIOS default table
F7 key	Load the optimized defaults
F10 key	Save all the CMOS changes and exit

2.1 Main Menu

Once you enter Award BIOS™ CMOS Setup Utility, the Main Menu will appear on the screen. The Main Menu allows you to select from several setup functions. Use the arrow keys to select among the items and press <Enter> to accept and enter the sub-menu.

!! WARNING !!

The information about BIOS defaults on manual (**Figure 1,2,3,4,5,6,7,8,9,10,11,12,13,14**) is just for reference, please refer to the BIOS installed on board for update information

■ **Figure 1. Main Menu**

CMOS Setup Utility-Copyright (C) 1984-2000 Award Software

▶ Standard CMOS Features	▶ Frequency/Voltage Control
▶ Advanced BIOS Features	Load Fail-Safe Defaults
▶ Advanced Chipset Features	Load Optimized Defaults
▶ Integrated Peripherals	Set Supervisor Password
▶ Power Management Setup	Set User Password
▶ PnP/PCI Configurations	Save & Exit Setup
▶ PC Health Status	Exit Without Saving
Esc : Quit F9 : Menu in BIOS ↑ ↓ → ← : Select Item	
F10 : Save & Exit Setup	
Time, Date, Hard Disk Type...	

Standard CMOS Features

This setup page includes all the items in standard compatible BIOS.

Advanced BIOS Features

This setup page includes all the items of BIOS special enhanced features.

Advanced Chipset Features

This setup page includes all the items of chipset special features.

Integrated Peripherals

This section page includes all the items of IDE hard drive and Programmed Input/Output features.

Power Management Setup

This setup page includes all the items of power management features.

PnP/PCI Configurations

This setup page includes IRQ Setting by user define or default.

PC Health Status

This page shows the hardware Monitor information of the system.

Frequency/Voltage Control

This page shows the hardware Monitor information of the system.

Load Fail-Safe Defaults

Use this menu to load the BIOS default values for the minimal/stable performance for your system to operate.

Load Optimized Defaults

These settings are more likely to configure a workable computer when something is wrong. If you cannot boot the computer successfully, select the BIOS Setup options and try to diagnose the problem after the computer boots. These settings do not provide optimal performance.

Set Supervisor Password

Change, set, or disable password. It allows you to limit access to the system and Setup, or just to Setup.

Set User Password

You can specify both an User and a Supervisor password. When you select either password option, you are prompted for a 1-8 character password. Enter the password and then retype the password when prompted.

Save & Exit Setup

Save CMOS value changes to CMOS and exit setup.

Exit Without Saving

Abandon all CMOS value changes and exit setup.

2.2 Standard CMOS Features

The items in Standard CMOS Setup Menu are divided into 10 categories. Each category includes no, one or more than one setup items. Use the arrow keys to highlight the item and then use the <PgUp> or <PgDn> keys to select the value you want in each item.

■ Figure 2. Standard CMOS Setup

CMOS Setup Utility-Copyright (C) 1984-2000 Award Software
Standard CMOS Features

Date (mm:dd:yy)	Tue, Jun 6 2000	Item Help
Time (hh:mm:ss)	11 : 26 : 10	
▶ IDE Primary Master	Maxtor 54098H8	Menu Level ▶ Change the day, month, year and century.
▶ IDE Primary Slave	None	
▶ IDE Secondary Master	None	
▶ IDE Secondary Slave	None	
Drive A	1.44M, 3.5 in	
Drive B	None	
Video	EGA/VGA	
Halt On	All, But Keyboard	
Base Memory	640K	
Extended Memory	65472K	
Total Memory	1024K	

↑ ↓ → ← : Move Enter : Select +/-/PU/PD : Value F10 : Save ESC : Exit F1 : General Help
F5 : Previous Values F6 : Fail-Safe Defaults F7 : Optimized Defaults

Main Menu Selections

This table shows the selections that you can make on the Main Menu.

Item	Options	Description
Date	Month DD YYYY	Set the system date. Note that the 'Day' automatically changes when you set the date.
IDE Primary Master	Options are in its sub menu.	Press <Enter> to enter the sub menu of detailed options
IDE Primary Slave	Options are in its sub menu.	Press <Enter> to enter the sub menu of detailed options.
IDE Secondary Master	Options are in its sub menu.	Press <Enter> to enter the sub menu of detailed options.
IDE Secondary Slave	Options are in its sub menu.	Press <Enter> to enter the sub menu of detailed options.
Drive A Drive B	None 360K, 5.25 in 1.2M, 5.25 in 720K, 3.5 in 1.44M, 3.5 in 2.88M, 3.5 in	Select the type of floppy disk drive installed in your system.
Video	EGA/VGA CGA 40 CGA 80 MONO	Select the default video device.

Item	Options	Description
Halt On	All Errors No Errors All, but Keyboard All, but Diskette All, but Disk/ Key	Select the situation in which you want the BIOS to stop the POST process and notify you.
Base Memory	N/A	Displays the amount of conventional memory detected during boot up.
Extended Memory	N/A	Displays the amount of extended memory detected during boot up.
Total Memory	N/A	Displays the total memory available in the system.

2.3 Advanced BIOS Features

■ Figure 3. Advanced BIOS Setup

CMOS Setup Utility-Copyright (C) 1984-2000 Award Software
Advanced BIOS Features

▶	Boot Device Select	Press Enter	Item Help
▶	Shadow Control	Press Enter	
	Anti-Virus Protection	Enabled	Menu Level ▶
	CPU L1 Cache	Enabled	
	CPU L2 Cache	Enabled	
	CPU L2 Cache ECC Checking	Enabled	
	Quick Power On Self Test	Enabled	
	Swap Floppy Drive	Disabled	
	Boot Up Floppy Seek	Enabled	
	Boot Up NumLock Status	On	
	Gate A20 Option	Fast	
	Typematic Rate Setting	Disabled	
X	Typematic Rate (Chars/Sec)	6	
X	Typematic Delay (Msec)	250	
	Security Option	Setup	
	OS Select For DRAM > 64MB	Non-OS2	

↑ ↓ → ← : Move Enter : Select +/-/PU/PD : Value F10 : Save ESC : Exit F1 : General Help
F5 : Previous Values F6 : Fail-Safe Defaults F7 : Optimized Defaults

Boot Device Select

These BIOS attempts to load the operating system from the devices in the sequence selected in these items.

First/Second/Third/Boot Device

The Choices: Floppy, LS120, HDD-0, SCSI, CDROM, HDD-1, HDD-2, HDD-3, ZIP100, LAN, Disabled

Boot Other Device

The Choices: Enabled (default), Disabled

Shadow Control

If you highlight the literal “Press Enter” next to the “Shadow Control” label and then press the enter key, it will take you a submenu with the following options:

Video BIOS Shadow

Determines whether video BIOS will be copied to RAM for faster execution.

Enabled (default) Optional ROM is shadowed.
Disabled Optional ROM is not shadowed.

C8000 - CFFFF Shadow / D0000 - DFFFF Shadow

Determines whether the optional ROM will be copied to RAM for faster execution.

Enabled Optional ROM is shadowed.
Disabled (default) Optional ROM is not shadowed.

Note : For C8000 - DFFFF option - ROM on PCI BIOS, BIOS will automatically enable the shadow RAM. User does not have to select the item.

Anti-Virus Protection

This option allows you to choose the VIRUS Warning feature for IDE Hard Disk boot sector protection. If this function is enabled and someone attempt to write data into this area, BIOS will show a warning message on screen and alarm beep.

The Choices: **Enabled** (default), Disabled.

CPU L1 Cache

This category speeds up memory access. However, it depends on CPU/Chipset design.

Enabled (default) Enable cache.
Disabled Disable cache.

CPU L2 Cache

This field allows you to Enable or Disable the CPU’s “Level 2” secondary cache. Caching allows better performance.

Enabled (default) Enable cache.
Disabled Disable cache.

CPU L2 Cache ECC Checking

This item allows you to enable/disable CPU L2 Cache ECC Checking.

The Choices: **Enabled** (default), Disabled.

Quick Power On Self Test

This category speeds up Power on Self-Test (POST) after you power up the computer. If it is set to Enable, Bios will shorten or skip some check items during POST.

Enabled (default)	Enable quick POST.
Disabled	Normal POST.

Swap Floppy Drive

If the system has two floppy drives, you can swap the logical drive name assignments.

The Choices: Enabled, **Disabled** (default).

Boot Up Floppy Seek

Seeks disk drives during boot up. Disabling speeds boot-up.

The Choices: Enabled (default), Disabled.

Boot Up NumLock Status

Select power on state for NumLock.

On (default)	Numpad is number keys.
Off	Numpad is arrow keys.

Gate A20 Option

Select if chipset or keyboard controller should control Gate A20.

Normal	A pin in the keyboard controller controls Gate A20.
Fast (default)	Lets chipset control Gate A20.

Typematic Rate Setting

This determines the typematic rate.

Enabled	Enable typematic rate and typematic delay programming.
Disabled (default)	Disable typematic rate and typematic delay programming. The system BIOS will use default value and the keyboard controls the function.

Typematic Rate (Chars / Sec)

6 (default)	6 characters per second
8	8 characters per second
10	10 characters per second
12	12 characters per second
15	15 characters per second
20	20 characters per second
24	24 characters per second
30	30 characters per second

Typematic Delay (Msec)

Choose the length of delay from the time you press a key and the character repeating. (units are mil-sec)

The Choices: 250 (default), 500, 750, 1000.

Security Option

This category allows you to limit access to the system and Setup, or just to Setup.

System	The system will not boot and access to Setup will be denied if the correct password is not entered in prompt.
Setup (default)	The system will boot, but access to Setup will be denied if the correct password is not entered at the prompt.

OS Select For DRAM > 64MB

Select the operating system that is running with greater than 64MB of RAM on the system.

The Choices: Non-OS2 (default), OS2.

2.4 Advanced Chipset Features

This section allows you to configure the system based on the specific features of the installed chipset. This chipset manages bus speeds and access to system memory resources, such as DRAM and the external cache. It also coordinates communications the PCI bus. It must be stated that these items should never need to be altered. The default settings have been chosen because they provide the best operating conditions for your system. The only time you might consider making any changes would be if you discovered that data was being lost while using your system.

■ Figure 4. Advanced Chipset Setup

CMOS Setup Utility-Copyright (C) 1984-2000 Award Software
Advanced Chipset Features

▶ Onchip Device Control	Press Enter	Item Help
▶ Chipset Specific Feature	Press Enter	
▶ AGP device control	Press Enter	
DRAM Timing By SPD	Disabled	Menu Level ▶
DRAM Clock	Host CLK	
SDRAM Cycle Length	3	
Bank Interleave	Disabled	
System BIOS Cacheable	Disabled	
Video RAM Cacheable	Disabled	
K7 CLK_CTL Select	Optimal	

↑ ↓ → ← : Move Enter :Select +/-/PU/PD :Value F10 :Save ESC :Exit F1 :General Help
F5 :Previous Values F6 :Fail-Safe Defaults F7 : Optimized Defaults

Onchip Device Control

If you highlight the literal “Press Enter” next to the “Onchip Device Control” label and then press the enter key, it will take you a submenu with the following options:

OnChip Sound

The default setting of this item utilizes an onboard sound chip for audio output. There is no need to buy and insert a sound card. If sound card is installed, disable this item.

The Choices: Auto (default), Disabled.

OnChip Modem

This item allows you to control the onboard MC97 Modem controller.

The Choices: **Auto** (default), Disabled.

OnChip USB/USB2

This should be enabled if your system has an USB installed on the system board and you wish to use it. Even when so equipped, if you add a higher performance controller, you will need to disable this feature.

The Choices: **Enabled** (default), Disabled.

USB Keyboard Support

Select Enabled if your system contains an Universal Serial Bus (USB) controller and you have an USB keyboard.

The Choices: **Disabled** (default), Enabled.

Chipset Specific Feature

This setup page includes all the items of chipset special features.

PCI Master Pipeline Req

This item allows you to enable/disable the PCI master pipeline request feature.

The Choices: Enabled, **Disabled** (default).

P2C/C2P Concurrency

This item allows you to enable/disable the PCI to CPU, CPU to PCI concurrency.

The Choices: Enabled, **Disabled** (default).

Fast R-W Turn Around

This item controls the DRAM timing. It allows you to enable/disable the fast read/write turn around.

The Choices: Enabled, **Disabled** (default).

CPU to PCI Write Buffer

When enabled, up to four Dwords of data. Can be written to the PCI bus without interrupting the CPU. When disabled, a write buffer is not used and the CPU read cycle will not be completed until the PCI bus signals that it is ready to receive the data.

The Choices: **Enabled** (default), Disabled.

PCI Dynamic Bursting

When Enabled, every write transaction goes to the write buffer. Burstable transactions burst on the PCI bus and nonburstable transactions don't.

The Choices: Enabled (default), Disabled.

PCI Master 0 Ws Write

When Enabled, writes to the PCI bus are executed with zero-wait states.

The Choices: Enabled (default), Disabled.

PCI Delay Transaction

The chipset has an embedded 32-bit posted write buffer to support delay transactions cycles. Select Enabled to support compliance with PCI specification.

The Choices: Enabled, Disabled (default).

PCI #2 Access #1 Retry

When enabled, PCI # 2 will be disconnected if max retries are attempted without success (default).

When disabled, PCI # 2 will not be disconnected until access finishes.

The Choices: Enabled (default), Disabled.

AGP device control

If you highlight the literal "Press Enter" next to the "AGP device control" label and then press the enter key, it will take you a submenu with the following options:

AGP Mode

This item allows you to select the AGP Mode.

The Choices: 1X, 2X, 4X (Default).

AGP Aperture Size

Select the size of the Accelerated Graphics Port (AGP) aperture. The aperture is a portion of the PCI memory address range dedicated for graphics memory address space. Host cycles that hit the aperture range are forwarded to the AGP without any translation.

The Choices: 64M, 32M, 16M, 8M, 4M, 128M(default).

AGP Driving Control

By choosing "Auto" the system BIOS will the AGP output Buffer Drive strength P Ctrl by AGP Card. By choosing "Manual", it allows user to set AGP output Buffer Drive strength P Ctrl by manual.

The Choices: Auto (default), Manual.

AGP Driving Value

While AGP driving control item set to "Manual", it allows user to set AGP driving.

The Choices: Auto (default), Manual.

AGP Master 1 WS Write

When Enabled, writes to the AGP(Accelerated Graphics Port) are executed with one wait states.

The Choices: Enabled, Disabled (default).

AGP Master 1 WS Read

When Enabled, read to the AGP(Accelerated Graphics Port) are executed with one wait states.

The Choices: Enabled, Disabled (default).

Frame Buffer Size

This item allows you to set frame butter size.

The Choices: 8M (default), 16M, 32M

DRAM Timing By SPD

This item determines DRAM clock/timing follow SPD or not.

The Choices: Enabled, Disabled (default).

DRAM Clock

This item determines DRAM Clock following the CPU host clock, 100 or 133MHz.

The Choices: Host CLK (default), HCLK+33M

SDRAM Cycle Length

When synchronous DRAM is installed, the number of clock cycles of CAS latency depends on the DRAM timing. Do not reset this field from the default value specified by the system designer.

The Choices: 3 (default), 2.

Bank Interleave

This item allows you to enable or disable the bank interleave feature.

The Choices: **Disabled** (default), 2Bank,4Bank.

System BIOS Cacheable

When enabled, accesses to system BIOS ROM addressed at F0000H-FFFFFH are cached, provided that the cache controller is enabled.

The Choices: Enabled, **Disabled** (default).

Video RAM Cacheable

Select Enabled allows caching of the video BIOS, resulting in better system performance. However, if any program writes to this memory area, a system error may result.

The Choices: **Disabled** (default), Enabled.

K7 CLK CTL Select

Use this item to specify the clock control for ramp rate. Select default for a defaulted time value, and optimum time value which depends on different CPU ratio.

The Choices: Default, **Optimal** (default).

2.5 Integrated Peripherals

■ Figure 5. Integrated Peripherals

CMOS Setup Utility-Copyright (C) 1984-2000 Award Software
Integrated Peripherals

▶	OnChip IDE Control	Press Enter	Item Help
▶	Muti-Media setting	Press Enter	
	Init Display First	PCI Slot	Menu Level ▶
	Onboard FDD Controller	Enabled	
	Onboard Serial Port 1	Auto	
	Onboard IR Port	Disabled	
	UART 2 Mode	HPSIR	
X	IR Function Duplex	Half	
X	TX,RX inverting enable	No,Yes	
	Onboard Parallel Port	378 / IRQ7	
	Onboard Parallel Mode	Normal	
X	ECP Mode Use DMA	3	
X	Parallel Port EPP Type	EPP1.9	

↑ ↓ → ← : Move Enter :Select +/-/PU/PD :Value F10 :Save ESC :Exit F1 :General Help
F5 :Previous Values F6 :Fail-Safe Defaults F7 : Optimized Defaults

OnChip IDE Control

The chipset contains a PCI IDE interface with support for two IDE channels. Select "Enabled" to activate the first and/or second IDE interface. Select "Disabled" to deactivate an interface, if you install a primary and/or secondary add-in IDE interface. If you highlight the literal "Press Enter" next to the "Onchip IDE Control" label and then press the enter key, it will take you a submenu with the following options:

OnChip IDE Channel 0

The chipset contains a PCI IDE interface with support for two IDE channels. Select Enabled to activate the primary IDE interface. Select Disabled to deactivate this interface.

The Choices: Enabled (default), Disabled.

OnChip IDE Channel 1

The chipset contains a PCI IDE interface with support for two IDE channels. Select Enabled to activate the secondary IDE interface. Select Disabled to deactivate this interface.

The Choices: Enabled (default), Disabled.

IDE Prefetch Mode

The onboard IDE drive interfaces supports IDE prefetching, for faster drive access. If you install a primary and/or secondary add-in IDE interface, set this field to Disabled if the interface does not support prefetching.

The Choices: Enabled (default), Disabled.

Primary/Secondary Master/Slave PIO

The four IDE PIO (Programmed Input/Output) fields lets you set a PIO mode(0-4) for each of the IDE devices that the onboard IDE interface supports. Modes 0 through 4 provide successively increased performance. In Auto mode, the system automatically determines the best mode for each device.

The Choices: Auto (default), Mode0, Mode1, Mode2, Mode3, Mode4.

Primary/Secondary Master/Slave UDMA

Ultra DMA/66 implementation is possible only if your IDE hard drive supports it and the operating environment includes a DMA driver (Windows 98 OSR2 or a third-party IDE bus master driver). If your hard drive and your system software both support Ultra DMA/66, select Auto to enable BIOS support.

The Choices: Auto (default), Disabled.

IDE HDD Block Mode

Block mode is also called block transfer, multiple commands, or multiple sector read/write. If your IDE hard drive supports block mode (most new drives do), select Enabled for automatic detection of the optimal number of block read/writes per sector the drive can support.

The Choices: Enabled (default), Disabled.

Muti-Media setting

The multimedia setting submenu is used to configure various multimedia peripherals such as audio and game equipment. If you highlight the literal "Press Enter" next to the "Muti-Media setting" label and then press the enter key, it will take you a submenu with the following options:

Onboard Legacy Audio

This field controls the onboard legacy audio.

The Choices: Enabled (default), Disabled.

Sound Blaster

Hardware SoundBlaster Pro for Windows DOS box and real-mode DOS legacy compatibility.

The Choices: Enabled, Disabled (default).

SB I/O Base Address

Change the SoundBlaster Pro Base I/O Address settings.

The Choices: 220H(default), 240H, 260H, 280H.

SB IRQ Select

Change the SoundBlaster Pro interrupt signal.

The Choices: IRQ5(default), IRQ7, IRQ9, IRQ10.

SB DMA Select

Change the SoundBlaster Pro direct memory access setting.

The Choices: DMA0, DMA1 (default), DMA2, DMA3.

MPU-401

Enable or Disable MPU-401 function.

The Choices: Enabled (default), Disabled.

MPU-401 I/O Address

Change the SoundBlaster Pro MPU-401 I/O address.

The Choices: 300-303H, 310-313H, 320-323H, 330-333H (default).

Game Port (200-207H)

Change the joystick connect port address.

The Choices: Enabled (default), Disabled.

Init Display First

This item allows you decide to active whether PCI Slot or AGP Slot.

The Choices: PCI Slot (default), AGP.

Onboard FDD Controller

Select Enabled if your system has a floppy disk controller (FDC) installed on the system board and if you wish to use it. If install and FDC or the system has no floppy drive, select Disabled in this field.

The Choices: Enabled (default), Disabled.

Onboard Serial Port 1

Select an address and corresponding interrupt for the serial port.

The Choices: Disabled, Auto (default), 3F8/IRQ4, 2F8/IRQ3, 3E8/IRQ4, 2E8/IRQ3.

Onboard IR Port

Select an address and corresponding interrupt for the IR port.

The Choices: Enabled, Disabled (default).

UART 2 Mode

This item allows you to determine which InfraRed (IR) function of the onboard I/O chip, you wish to use.

The Choices: HPSIR (default), ASKIR.

IR Function Duplex

This item allows you to determine which InfraRed (IR) function of onboard I/O chip.

The Choices: Half (default), Full.

TX, RX inverting enable

This item allows you to determine the active of Tx, Rx.

The Choices: No/No, No/Yes (default), Yes/No, Yes/Yes.

Onboard Parallel Port

This item allows you to determine access onboard parallel port controller with which I/O address.

The Choices: Disable, 3BC/IRQ7, 378/IRQ7 (default), 278/IRQ5

Onboard Parallel Mode

Select an operating mode for the onboard parallel (printer) port. Select Normal unless you are certain your hardware and software both support EPP or ECP mode.

The Choices: Normal (default), EPP (Enhanced Parallel Port), ECP (Extended Capabilities Port), ECP/EPP

ECP Mode Use DMA

Select a DMA channel for the parallel port for use during ECP mode.

The Choice: 3 (default), 1.

Parallel Port EPP Type

Select a DMA Channel for the port.

The Choice: EPP1.9 (default), EPP1.7.

2.6 Power Management Setup

The Power Management Setup allows you to configure your system to most effectively save energy while operating in a manner consistent with your own style of computer use.

■ Figure 6. Power Management Setup

CMOS Setup Utility-Copyright (C) 1984-2000 Award Software
Power Management Setup

ACPI function	Enabled	Item Help
▶ Power Management	Press Enter	
PM Control by APM	Yes	Menu Level ▶
Video Off Option	Suspend -> Off	
Video Off Method	V/H SYNC+Blank	
Modem Use IRQ	3	
Soft-Off by PWRBTN	Instant-Off	
▶ Wake Up Events	Press Enter	

↑ ↓ → ← : Move Enter :Select +/-/PU/PD :Value F10 :Save ESC :Exit F1 :General Help
F5 :Previous Values F6 :Fail-Safe Defaults F7 : Optimized Defaults

ACPI function

This item display status of the Advanced Configuration and Power Management (ACPI).

The Choices: Enabled (default), Disabled.

Power Management

This category allows you to select the type (or degree) of power saving and is directly related to the following modes:

1.HDD Power Down.

2.Doze Mode.

3.Suspend Mode.

If you highlight the literal “Press Enter” next to the “Power Management” label and then press the enter key, it will take you a submenu with the following options:

Power Management

This option allows you to set each mode individually. When not disabled, each of the ranges are from 1 min. to 1 hr. except for HDD Power Down which ranges from 1 min. to 15 min. and disable.

The Choices: **User Define** (default), Min Saving, Max Saving.

HDD Power Down

By default, this is “Disabled”, meaning that no matter the mode the rest of the system, the hard drive will remain ready. Otherwise, you have a range of choices from 1 to 15 minutes or Suspend. This means that you can elect to have your hard disk drive be turned off after a selected number of minutes or when the rest of the system goes into a suspend mode.

Disabled (default).

Doze Mode / Suspend Mode

The **Doze Mode**, and **Suspend Mode** fields set the Period of time after which each of these modes activate. At *Max Saving*, these modes activate sequentially (in the given order) after one minute; at *Min Saving* after one hour.

PM Control by APM

No	System BIOS will ignore APM when power Management is on.
Yes (default)	System Bios will wait for APM's prompt before it enters any PM mode.

Video Off Option

This field determines when to activate the video off feature for monitor power management.

The Choices: Always on, **Suspend**→**Off** (default), All Modes→Off.

Video Off Method

This determines the manner in which the monitor is blanked.

V/H SYNC+Blank (default)	This selection will cause the system to turn off the vertical and horizontal synchronization ports and write blanks to the video buffer.
Blank Screen	This option only writes blanks to the video buffer.
DPMS Support	Initial display power management signaling.

Modem Use IRQ

This determines the IRQ, which can be applied in MODEM use.

3 (default)

4 / 5 / 7 / 9 / 10 / 11 / NA

Soft-Off by PWRBTN

Pressing the power button for more than 4 seconds forces the system to enter the Soft-Off state when the system has “hung.”

The Choices: Delay 4 Sec, **Instant-Off** (default)

Wake Up Events

If you highlight the literal “Press Enter” next to the “Wake Up Events” label and then press the enter key, it will take you a submenu with the following options:

VGA

When set to On, any event occurring at a VGA port will awaken a system which has been powered down.

The Choices: OFF (default), ON.

LPT & COM

When set to On, any event occurring at a COM(serial)/LPT (printer) port will awaken a system which has been powered down.

The Choices: None, LPT, COM, **LPT/COM** (default).

HDD & FDD

When set to On (default), any event occurring at a hard or floppy drive will awaken a system which has been powered down.

The Choices: OFF, **ON** (default).

PCI Master

When set to On, any event occurring at PCI will awaken a system which has been powered down.

The Choices: **OFF** (default), ON.

Power On by PCI Card

When you select Enabled, a PME signal from PCI card returns the system to Full ON state.

The Choices: Enabled, **Disabled** (default).

Wake Up On LAN/Ring

To use this function, you need a LAN add-on card which support power on function. It should also support the wake-up on LAN jump.

Disabled (default) Wake up on LAN/Ring not supported.

Enabled Wake up on LAN/Ring supported.

RTC Alarm Resume

When "Enabled", you can set the date and time at which the RTC (real-time clock) alarm awakens the system from Suspend mode.

The Choices: Enabled, **Disabled** (default).

Primary INTR

When set to ON (default), any event occurring at Primary INTR will awaken a system which has been powered down.

The following is a list of IRQ, Interrupt ReQuests, which can be exempted much as the COM ports and LPT ports above can. When an I/O device wants to gain the attention of the operating system, it signals this by causing an IRQ to occur. When the operating system is ready to respond to the request, it interrupts itself and performs the service.

As above, the choices are ON and OFF. ON is the default.

When set On, activity will neither prevent the system from going into a power management mode nor awaken it.

IRQ3	(COM2)
IRQ4	(COM1)
IRQ5	(LPT2)
IRQ6	(Floppy Disk)
IRQ7	(LPT1)
IRQ8	(RTC Alarm)
IRQ9	(IRQ2 Redir)
IRQ10	(Reserved)
IRQ11	(Reserved)
IRQ12	(PS/2 Mouse)
IRQ13	(Coprocessor)
IRQ14	(Hard Disk)
IRQ15	(Reserved)

2.7 PnP/PCI Configurations

This section describes configuring the PCI bus system. PCI, or Personal Computer Interconnect, is a system which allows I/O devices to operate at speeds nearing the speed of the CPU itself uses when communicating with its own special components. This section covers some very technical items and it is strongly recommended that only experienced users should make any changes to the default settings.

■ Figure 7. PnP/PCI Configurations

CMOS Setup Utility-Copyright (C) 1984-2000 Award Software
PnP/PCI Configurations

PNP OS Installed	No	Item Help
Reset Configuration Data	Disabled	
Resources Controlled By	Auto (ESCD)	Menu Level ▶
X IRQ Resources	Press Enter	Select Yes if you are using a Plug and Play capable operating system Select No if you need the BIOS to configure non-boot devices
X DMA Resources	Press Enter	
PCI/VGA Palette Snoop	Disabled	
Assign IRQ For VGA	Enabled	
Assign IRQ For USB	Enabled	

↑ ↓ → ← : Move Enter :Select +/-/PU/PD :Value F10 :Save ESC :Exit F1 :General Help
F5 :Previous Values F6 :Fail-Safe Defaults F7 : Optimized Defaults

PnP OS Installed

When set to YES, BIOS will only initialize the PnP cards used for booting (VGA, IDE, SCSI). The rest of the cards will be initialized by the PnP operating system like Window™ 95. When set to NO, BIOS will initialize all the PnP cards. Therefore for non-PnP operating system (DOS, Netware™), this option must set to NO.

Reset Configuration Data

The system BIOS supports the PnP feature so the system needs to record which resource is assigned and proceeds resources from conflict. Every peripheral device has a node, which is called ESCD. This node records which resources are assigned to it. The system needs to record and update ESCD to the memory locations. These locations (4K) are reserved at the system BIOS.

If Disabled (default) is chosen, the system's ESCD will update only when the new configuration varies from the last one.

If Enabled is chosen, the system is forced to update ESCDs and then is automatically set to the "Disabled" mode.

IRQ-3	assigned to PCI PnP
IRQ-4	assigned to PCI PnP
IRQ-5	assigned to PCI PnP
IRQ-7	assigned to PCI PnP
IRQ-9	assigned to PCI PnP
IRQ-10	assigned to PCI PnP
IRQ-11	assigned to PCI PnP
IRQ-12	assigned to PCI PnP
IRQ-14	assigned to PCI PnP
IRQ-15	assigned to PCI PnP

The above settings will be shown on the screen only if "Manual" is chosen for the Resources Controlled By function.

Resources Controlled By

By Choosing "Auto (ESCD)" (default), the system BIOS will detect the system resources and automatically assign the relative IRQ and DMA channel for each peripheral.

By Choosing "Manual", the user will need to assign IRQ & DMA for add-on cards. Be sure that there are no IRQ/DMA and I/O port conflicts.

IRQ Resources

When resources are controlled manually, assign each system interrupt a type, depending on the type of device using the interrupt.

DMA Resources

When resources are controlled manually, assign each system DMA channel a type, depending on the type of device using the DMA channel.

PCI / VGA Palette Snoop

Choose Disabled or Enabled. Some graphic controllers which are not VGA compatible take the output from a VGA controller and map it to their display as a way to provide boot information and VGA compatibility.

Disabled (default)	Disables the function.
Enabled	Enables the function.

Assign IRQ For VGA

Lets the user choose which IRQ to assign for the VGA.

Assign IRQ For USB

Lets the user choose which IRQ to assign for the USB.

2.8 PC Health Status

■ Figure 8. PC Health Status

CMOS Setup Utility-Copyright (C) 1984-2000 Award Software
PC Health Status

Show H/W Monitor in POST	3 sec	Item Help
Current CPUFAN1 Speed	4783RPM	Menu Level ►
Current SysFAN Speed	0RPM	
Vcore	1.78V	
VccSRAM	3.13V	
3.3V	3.12V	
5V	4.88V	
12V	12.06V	

↑ ↓ → ← : Move Enter :Select +/-/PU/PD :Value F10 :Save ESC :Exit F1 :General Help
 F5 :Previous Values F6 :Fail-Safe Defaults F7 : Optimized Defaults

Show H/W Monitor in POST

If your computer contains a monitoring system, it will show PC health status during POST stage. The item offers several delay times to you want.

The Choices: None, 1sec, 2sec, **3 sec** (default)

Current CPUFAN1 Speed

This field displays the current speed of CPU fan, if your computer contains a monitoring system.

Current SysFAN Speed

This field displays the current speed of system fan, if your computer contains a monitoring system.

Current CPU Vcore VccSRAM, 3.3V, 5V, 12V

Detect system's voltage status automatically.

2.9 Frequency/Voltage Control

■ Figure 9. Frequency/Voltage Control

CMOS Setup Utility-Copyright (C) 1984-2000 Award Software
Frequency / Voltage Control

Auto Detect DIMM / PCI Clk	Enabled	Item Help
CPU Host/PCI/Spread Spec.	Default	Menu Level ▶

↑ ↓ → ← : Move Enter :Select +/-/PU/PD :Value F10 :Save ESC :Exit F1 :General Help
 F5 :Previous Values F6 :Fail-Safe Defaults F7 : Optimized Defaults

Auto Detect DIMM / PCI CLK

This item allows you to enable/disable auto detect DIMM/PCI Clock.

The Choices: Enabled (default), Disabled.

CPU Host / PCI / Spread Spec.

This item allows you to select CPU Host Clock (CPU / PCI).



If unfortunately, the system's frequency that you are selected is not functioning, there are two methods of booting-up the system.

Method 1: Clear the COMS data by setting the JCOMS1 ((2-3) closed)) as "ON" status. All the CMOS data will be loaded as defaults setting.

Method 2: Press the <Insert> key and Power button simultaneously, after that keep-on pressing the <Insert> key until the power-on screen showed. This action will boot-up the system according to FSB of the processor.

2.10 Load Fail-Safe Defaults

When you press <Enter> on this item, you get a confirmation dialog box with a message similar to:

■ **Figure 10. Load Fail-Safe Defaults**

CMOS Setup Utility-Copyright (C) 1984-2000 Award Software

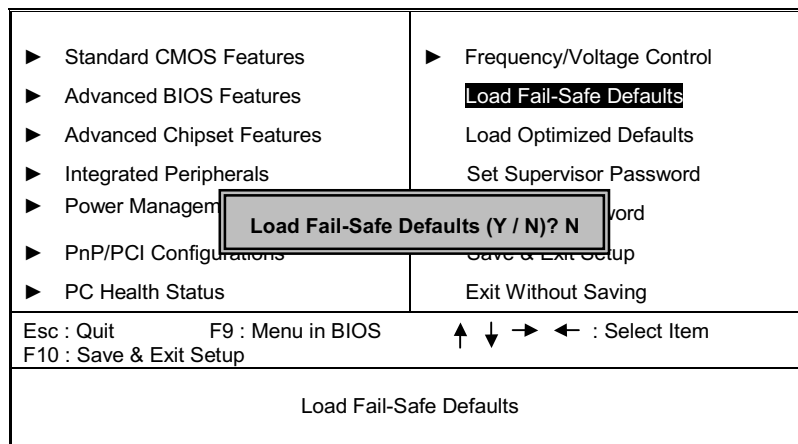

Pressing 'Y' loads the default values for the most stable, minimal performance system operations.

2.11 Load Optimized Defaults

When you press <Enter> on this item, you get a confirmation dialog box with a message similar to:

■ Figure 11. Load Optimized Defaults

CMOS Setup Utility-Copyright (C) 1984-2000 Award Software

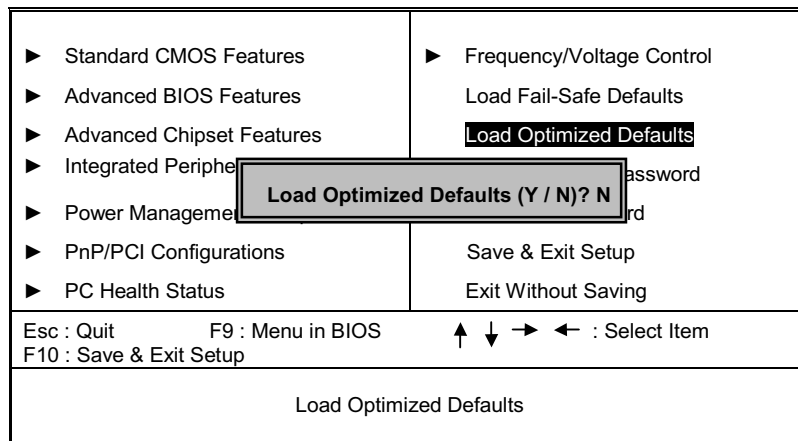

Pressing 'Y' loads the default values that are factory settings for optimal performance system operations.

2.12 Set Supervisor / User Password

■ Figure 12. Set Supervisor / User Password

CMOS Setup Utility-Copyright (C) 1984-2000 Award Software

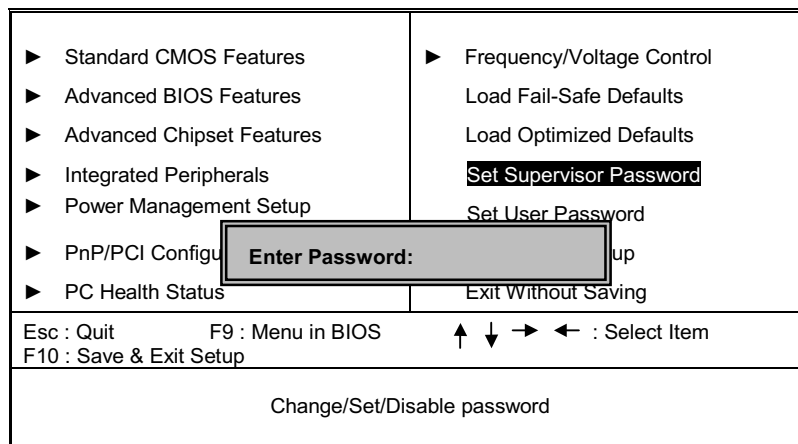

When you select this function, the following message will appear at the center of the screen to assist you in creating a password.

ENTER PASSWORD

Type the password, up to eight characters, and press <Enter>. The password you type now will clear any previously entered password from CMOS memory. You will be asked to confirm the password. Type the password again and press <Enter>. You may also press <ESC> to abort the selection and not enter a password. To disable password, just press <Enter> when you are prompted to enter password. A message will confirm that you wish to disable the password. Once the password is disabled, the system will boot and you can enter setup freely.

PASSWORD DISABLED

If you select "System" at the Security Option of BIOS Features Setup Menu, you will be prompted for the password every time when the system is rebooted, or any time when you try to enter Setup. If you select "Setup" at Security Option of BIOS Feature Setup Menu, you will be prompted only when you try to enter Setup.

2.13 Save & Exit Setup

■ Figure 13. Save & Exit Setup

CMOS Setup Utility-Copyright (C) 1984-2000 Award Software

▶ Standard CMOS Features	▶ Frequency/Voltage Control
▶ Advanced BIOS Features	Load Fail-Safe Defaults
▶ Advanced Chipset Features	Load Optimized Defaults
▶ Integrated Peripherals	Set Supervisor Password
▶ Power Management Setup	Set User Password
▶ PnP/PCI Configurations	Save & Exit Setup
▶ PC Health Status	Exit Without Saving
Esc : Quit F9 : Menu in BIOS ↑ ↓ → ← : Select Item	
F10 : Save & Exit Setup	
Save Data to CMOS	

Type "Y" will quit the Setup Utility and save the user setup value to RTC CMOS RAM.
Type "N" will return to Setup Utility.

2.14 Exit Without Saving

■ Figure 14. Exit Without Saving

CMOS Setup Utility-Copyright (C) 1984-2000 Award Software

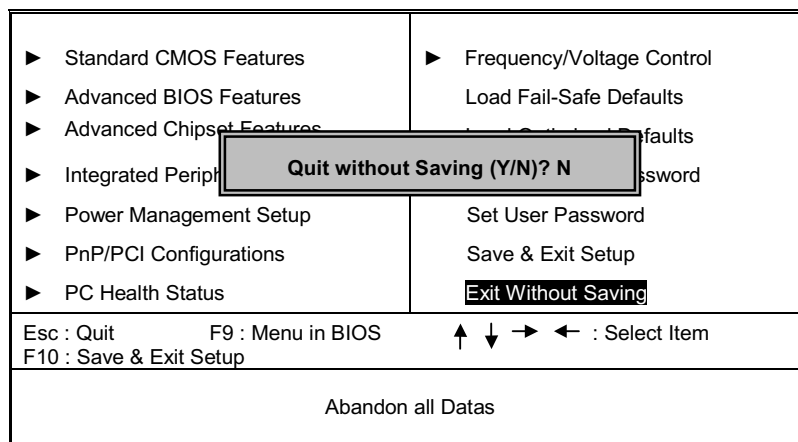

Type "Y" will quit the Setup Utility without saving to RTC CMOS RAM.
Type "N" will return to Setup Utility.

3. Software Setup

NOTE: The mark * means it can be installed directly from CD by using CD Installation Utility (i.e. SETUP.EXE).

3.1 Software List

Category	Description	Platform	Location in CD
VIA Service Pack (4 In 1) *	VIA 4 In 1 driver includes (VIA Registry (ACPI) Driver /VIA AGP VxD driver /VIA ATAPI Vendor Support Driver /VIA PCI IRQ Miniport Driver) four system drivers to improve the performance and maintain the stability of system using VIA chipset.	Windows 95/98/NT4/ME /2000	\Driver\Chipset \Via\Service
VIA Hardware Monitor *	VIA Hardware Monitor is a self-diagnostic system for PC.	Windows 95/98/NT4/ME /2000	\Driver\Chipset \Via\Sysdiag
Award Flash Utility	Used for updating BIOS.	Need to be run under DOS environment.	\Software\ Flash
VIA AC97 Audio * (Option)	Install the driver to enable the VIA AC97 Audio Device	Windows 95/98/NT4/ME /2000	\Driver\Audio\ Via686
VIA Display Driver *	Install the driver to enable the S3 video On-chip Device.	Windows 95/98/NT4/ME /2000	\Driver\Chipset \Via\VGA\ 8365
Microsoft DCOM *	Install the MicroSoft Distributed Component Object Model (DCOM) server for Windows O.S.	Windows 95/98	\Software\ DCOM
Microsoft DirectX 8.0 *	Microsoft DirectX runtime library	Windows 95/98/ME/2000	\Software\ DirectX

3.2 Software Installation

We provide an installation wizard, Driver CD Installation Utility (SETUP.EXE), located in the root of Driver CD to let users install some common used drivers conveniently.

The Wizard can automatically detect OS and switch to the proper page, so you don't need to worry about installing the wrong drivers.

You can simply put Driver CD into CD-ROM drive and the Installation Utility will autorun or you can launch the Driver CD Installation Utility manually.



There are two kinds of Installation Procedure:**➤ Automatically Install drivers from CD by using CD Installation Utility:**

Use the mouse cursor to click the proper option on the page. Utility will invoke other applications to complete the rest of installation.

➤ When the drivers CAN NOT be installed directly from CD by using CD Installation Utility, please do the following procedure :

Please read the README.TXT located in the root directory on Driver CD to get the driver's location and then refer to the INSTALL.TXT or README.TXT files located in each driver's directory on the Driver CD to install drivers

3.3 Using Software

- In general, you can get more detailed information in the on-line help or readme for the softwares.
- **Using VIA Hardware Monitor**
After the utility is installed, you can follow the sequence, **Start**→ **Programs** → **VIA HM** → **VIA Hardware Monitor** , to launch the monitor application.

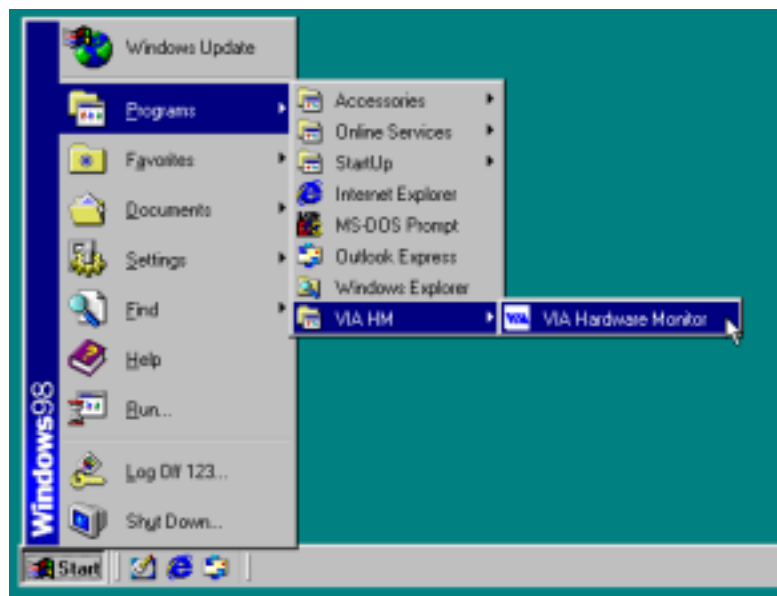

The following figure is the main panel of VIA Hardware Monitor. In the panel, you can get some real-time and important information -- Voltage, Fan speed, and temperature, for example. If there is an abnormal situation, you can resolve it immediately.

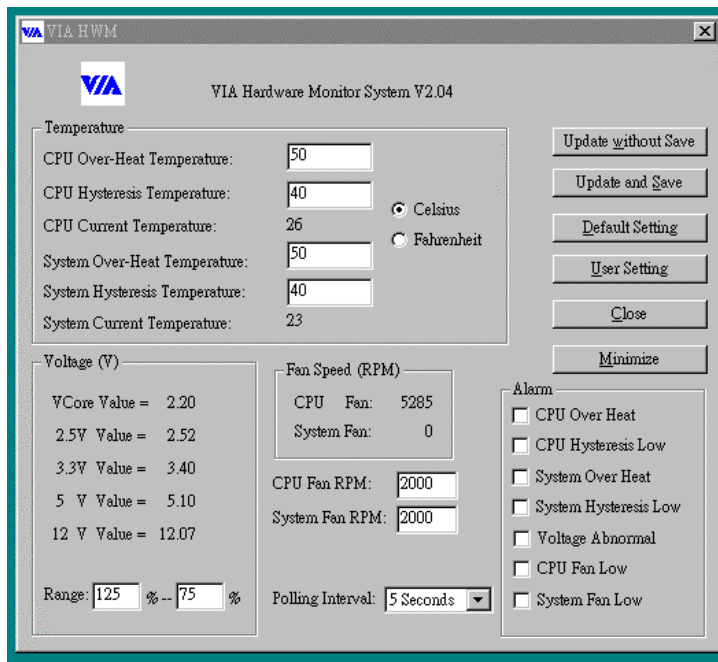

4. Trouble Shooting

PROBLEM

No power to the system at all. Power light does not illuminate, fan inside power supply does not turn on. Indicator light on keyboard does not turn on.

PROBABLE CAUSE	DIAGNOSIS	SOLUTION
Power cable is unplugged.	Visually inspect power cable.	Make sure power cable is securely plugged in.
Defective power cable.	Visually inspect the cable; try another cable.	Replace cable.
Power supply failure.	Power cable and wall socket are OK, but system is still dead.	Contact technical support.
Faulty wall outlet; circuit breaker or fuse blown.	Plug in device known to work in socket and test	Use different socket, repair outlet, reset circuit breaker or replace fuse.

PROBLEM

System inoperative. Keyboard lights are on, power indicator lights are lit, hard drive is spinning.

PROBABLE CAUSE	DIAGNOSIS	SOLUTION
Memory DIMM is partially dislodged from the slot on the motherboard.	Turn off computer. Take cover off system unit. Check the DIMM to ensure it is securely seated in the slot.	Using even pressure on both ends of the DIMM, press down firmly until the module snaps into place.

PROBLEM

System does not boot from hard disk drive, can be booted from CD-ROM drive.

PROBABLE CAUSE	DIAGNOSIS	SOLUTION
Connector between hard drive and system board unplugged.	When attempting to run the FDISK utility you get a message, INVALID DRIVE SPECIFICATION.	Check cable running from disk to disk controller board. Make sure both ends are securely plugged in; check the drive type in the standard CMOS setup.
Damaged hard disk or disk controller.	Format hard disk; if unable to do so the hard disk may be defective.	Contact technical support.
Hard disk directory or FAT is scrambled.	Run the FDISK program, format the hard drive. Copy data that was backed up onto hard drive.	Backing up the hard drive is extremely important. All hard disks are capable of breaking down at any time.

PROBLEM

System only boots from CD-ROM. Hard disk can be read and applications can be used but booting from hard disk is impossible.

PROBABLE CAUSE	DIAGNOSIS	SOLUTION
Hard Disk boot program has been destroyed.	A number of causes could be behind this.	Back up data and applications files. Reformat the hard drive. Re-install applications and data using backup disks.

PROBLEM

Error message reading “SECTOR NOT FOUND” or other error messages not allowing certain data to be retrieved.

PROBABLE CAUSE	DIAGNOSIS	SOLUTION
A number of causes could be behind this.	Use a file by file backup instead of an image backup to backup the hard disk.	Back up any salvageable data. Then low level format, partition, and high level format the hard drive. Re-install all saved data when completed.

PROBLEM

Screen message says “Invalid Configuration” or “CMOS Failure.”

PROBABLE CAUSE	DIAGNOSIS	SOLUTION
Incorrect information entered into the configuration (setup) program.	Check the configuration program. Replace any incorrect information.	Review system’s equipment . Make sure correct information is in setup.

PROBLEM

Screen is blank.

PROBABLE CAUSE	DIAGNOSIS	SOLUTION
No power to monitor.		Check the power connectors to monitor and to system. Make sure monitor is connected to display card.
Monitor not connected to computer.		See instructions above.

PROBLEM

PROBABLE CAUSE	DIAGNOSIS	SOLUTION
Memory problem.		Reboot computer. Reinstall memory, make sure that all memory modules are installed in correct sockets.
Computer virus.		Use anti-virus programs to detect and clean viruses.

PROBLEM

Screen goes blank periodically.

PROBABLE CAUSE	DIAGNOSIS	SOLUTION
Screen saver is enabled.		Disable screen saver.

PROBLEM

Keyboard failure.

PROBABLE CAUSE	DIAGNOSIS	SOLUTION
Keyboard is disconnected.		Reconnect keyboard. Check keys again, if no improvement replace keyboard.

PROBLEM

No color on screen.

PROBABLE CAUSE	DIAGNOSIS	SOLUTION
Faulty Monitor.		If possible, connect monitor to another system. If no color replace monitor.
CMOS incorrectly set up.		Call technical support.

PROBLEM

C: drive failure.

PROBABLE CAUSE	DIAGNOSIS	SOLUTION
Hard drive cable not connected properly.		Check hard drive cable.

PROBLEM

Cannot boot system after installing second hard drive.

PROBABLE CAUSE	DIAGNOSIS	SOLUTION
Master/slave jumpers not set correctly.		Set master/slave jumpers correctly.
Hard drives not compatible / different manufacturers.		Run SETUP program and select correct drive types. Call drive manufacturers for compatibility with other drives.

PROBLEM

Missing operating system on hard drive.

PROBABLE CAUSE	DIAGNOSIS	SOLUTION
CMOS setup has been changed.		Run setup and select correct drive type.

PROBLEM

Certain keys do not function.

PROBABLE CAUSE	DIAGNOSIS	SOLUTION
Keys jammed or defective.		Replace keyboard.

PROBLEM

Keyboard is locked, and no keys function.

PROBABLE CAUSE	DIAGNOSIS	SOLUTION
Keyboard is locked.		Unlock keyboard.

03/09/2001
MADE IN TAIWAN
R.O.C.