

PB6 I-V3

Rev. D+

**System Board
Carte Mère Manuel
System-Platine**

**User's Manual
Pour Utilisateur
Benutzerhandbuch**

Copyright

This publication contains information that is protected by copyright. No part of it may be reproduced in any form or by any means or used to make any transformation/adaptation without the prior written permission from the copyright holders.

This publication is provided for informational purposes only. The manufacturer makes no representations or warranties with respect to the contents or use of this manual and specifically disclaims any express or implied warranties of merchantability or fitness for any particular purpose. The user will assume the entire risk of the use or the results of the use of this document. Further, the manufacturer reserves the right to revise this publication and make changes to its contents at any time, without obligation to notify any person or entity of such revisions or changes.

© 1999. All Rights Reserved.

Trademarks

Microsoft® MS-DOS®, Windows™, Windows® 95 and Windows® 98 are registered trademarks of Microsoft Corporation. Intel®, Pentium® II, Pentium® III and Celeron™ are registered trademarks of Intel Corporation. Award is a registered trademark of Award Software, Inc. Other trademarks and registered trademarks of products appearing in this manual are the properties of their respective holders.

Caution:

Danger of explosion if battery incorrectly replaced.

Replace only with the same or equivalent type recommended by the manufacturer.

Dispose of used batteries according to the battery manufacturer's instructions.

FCC and DOC Statement on Class B

This equipment has been tested and found to comply with the limits for a Class B digital device, pursuant to Part 15 of the FCC rules. These limits are designed to provide reasonable protection against harmful interference when the equipment is operated in a residential installation. This equipment generates, uses and can radiate radio frequency energy and, if not installed and used in accordance with the instruction manual, may cause harmful interference to radio communications. However, there is no guarantee that interference will not occur in a particular installation. If this equipment does cause harmful interference to radio or television reception, which can be determined by turning the equipment off and on, the user is encouraged to try to correct the interference by one or more of the following measures:

- Reorient or relocate the receiving antenna.
- Increase the separation between the equipment and the receiver.
- Connect the equipment into an outlet on a circuit different from that to which the receiver is connected.
- Consult the dealer or an experienced radio TV technician for help.

Notice:

1. The changes or modifications not expressly approved by the party responsible for compliance could void the user's authority to operate the equipment.
2. Shielded interface cables must be used in order to comply with the emission limits.

Table of Contents / Sommaire / Inhaltsverzeichnis

Chapter 1 - Introduction

1.1 Features and Specifications	4
1.2 Package Checklist	7

Chapter 2 - Hardware Installation

2.1 System Board Layout	8
2.2 DIP Switch Settings of the Processors	9
2.3 Jumper Settings for the CPU's Front Side Bus	10
2.4 Jumper Settings for Clearing CMOS Data	11
2.5 Jumper Settings for Wake-On-Keyboard/Mouse	12
2.6 Connectors	13

Chapter 3 - Award BIOS Setup Utility

3.1 Entering the Award BIOS Setup Utility	19
3.2 Setting the Date and Time	20
3.3 Selecting the Hard Drive and Floppy Drive Type	21
3.4 Selecting the Drive to be Searched First for an Operating System	22
3.5 Setting the Processor Serial Number	23
3.6 Setting the External System Bus Clock of the Processor..	24
3.7 Selecting the Method of Powering-off the System	28
3.8 Selecting the Power Lost Resume State	29
3.9 Using the System Health Monitor Function	31
3.10 Setting the Wake-On-Keyboard/Mouse Function	34
3.11 Loading Fail-Safe Settings/Optimal Settings	38
3.12 Setting the Supervisor/User Password	38

Chapter 4 - Supported Softwares

4.1 Utility	40
-------------------	----

Appendix A - System Error Messages

A.1 POST Beep	41
A.2 Error Messages	41



Note:

The user's manual in the provided CD contains detailed information about the system board. If, in some cases, some information doesn't match those shown in this manual, this manual should always be regarded as the most updated version. To view the user's manual, insert the CD into a CD-ROM drive. The autorun screen (Main Board Utility CD) will appear. Click "User's Manual".

Chapter 1 - Introduction / Introduction / Einleitung

1.1 Features and Specifications

Caractéristiques et Spécifications

Leistungsmerkmale und Technische Daten

1.1.1 Features / Caractéristiques / Leistungsmerkmale

Chipset

- VIA® 693/596A AGPset

Processor

- 450/100MHz or 500/100MHz Pentium® III processor
- 233/66MHz, 266/66MHz, 300/66MHz, 333/66MHz, 350/100MHz, 400/100MHz or 450/100MHz Pentium® II processor
- 266/300/300A/333/366/400/433MHz Celeron™ processor (SEPP for Slot 1)

System Memory

- 16MB to 384MB memory using unbuffered DIMMs
- Three 168-pin DIMM sockets
- Uses x64 or x72 PC SDRAM, 3.3V
 - PC-66 SDRAM DIMM for 66MHz FSB processors
 - PC-100 SDRAM DIMM for 100MHz FSB processors
- ECC supported (uses x72 PC SDRAM DIMM)

DIMMs	Memory Size	DIMMs	Memory Size
2MBx64/x72	16MB	8MBx64/x72	64MB
4MBx64/x72	32MB	16MBx64/x72	128MB

Expansion Slots

The system board is equipped with 1 dedicated AGP slot, 3 dedicated PCI slots, 1 dedicated 16-bit ISA slot and 1 shared PCI/ISA slot. All PCI and ISA slots are bus masters.

Desktop Management Interface (DMI)

The system board comes with a DMI 2.0 built into the BIOS. The DMI utility in the BIOS automatically records various information about your system configuration and stores these information in the DMI pool, which is a part of the system board's Plug and Play BIOS. DMI, along with the appropriately networked software, is designed to make inventory, maintenance and troubleshooting of computer systems easier.

ATX Double Deck Ports

- 2 USB ports
- 2 DB-9 serial ports
- 1 DB-25 parallel port
- 1 mini-DIN-6 PS/2 keyboard port
- 1 mini-DIN-6 PS/2 mouse port

Connectors

- 1 connector for IrDA interface
- 2 IDE connectors
- 1 floppy connector
- 1 20-pin ATX power supply connector
- 1 3-pin WOL (Wake-On-LAN) connector
- 1 SB-LINK connector
- 3 fan connectors for CPU, chassis and AGP fans

PCI Bus Master IDE Controller

- Two PCI IDE interfaces support up to four IDE devices
- Ultra DMA/33 supported (Synchronous Ultra DMA mode - data transfer rate up to a maximum of 33MB/sec.)
- PIO Mode 3 and Mode 4 Enhanced IDE (data transfer rate up to 16.6MB/sec.)
- Bus mastering reduces CPU utilization during disk transfer
- ATAPI CD-ROM, LS-120 and ZIP supported

IrDA Interface

The system board is equipped with an IrDA connector for wireless connectivity between your computer and peripheral devices. It supports peripheral devices that meet the IrDA or ASKIR standard.

USB Ports

The system board is equipped with two USB ports. USB allows data exchange between your computer and a wide range of simultaneously accessible external Plug and Play peripherals.

BIOS

- Award BIOS, Windows® 95/98 Plug and Play compatible
- Flash EPROM for easy BIOS upgrades
- Includes NCR 810 SCSI BIOS
- 2MB flash memory

1.1.2 System Health Monitor Functions System Health Monitor Fonctions System Health Monitor Funktions

The system board is capable of monitoring the following “system health” conditions.

- Monitors processor/system temperature and processor overheat alarm
- Monitors 1.5V/3.3V/±5V/±12V/VCORE voltages and failure alarm
- Monitors processor/chassis fan speed and failure alarm
- Automatic processor/chassis fan control
- Read back capability that displays temperature, voltage and fan speed

1.1.3 Intelligence / Intelligence / Intelligente Ausstattungsteile

Automatic CPU/Chassis Fan Off

The CPU and chassis fans will automatically turn off once the system enters the Suspend mode.

Dual Function Power Button

Depending on the setting in the BIOS setup, this switch will allow your system to enter the Soft-Off or Suspend mode.

External Modem Ring-on

The Modem Ring-on feature allows the system that is in the Suspend mode or Soft Power Off mode to wake-up/power-on to respond to incoming calls. This feature supports external modem only.

RTC Timer to Power-On the System

The RTC installed on the system board allows your system to automatically power-on on the set date and time.

Wake-On-LAN Ready

The Wake-On-LAN function allows the network to remotely wake up a Soft Power Down (Soft-Off) PC. Your LAN card must support the remote wakeup function.



Important:

The 5VSB power source of your power supply must support $\geq 720\text{mA}$ (minimum).

Wake-On-Keyboard/Wake-On-Mouse

This function allows you to use the keyboard or mouse to power-on the system. Refer to sections 2.5 (chapter 2) and 3.10 (chapter 3) for more information.

**Important:**

- *The power button will not function once a keyboard password has been set in the “KB Power On Password” field of the Integrated Peripherals setup. You must type the correct password to power-on the system.*
- *The 5VSB power source of your power supply must support $\geq 720\text{mA}$ (minimum).*

ACPI

The system board is designed to meet the ACPI (Advanced Configuration and Power Interface) specification. ACPI has energy saving features that enables PCs to implement Power Management and Plug-and-Play with operating systems that support OS Direct Power Management.

Virus Protection

Most viruses today destroy data stored in hard drives. The system board is designed to protect the boot sector and partition table of your hard disk drive.

1.2 Package Checklist**Liste de Vérification de l’Emballage****Verpackungsliste**

The system board package contains the following items:

- The system board
- A user’s manual
- One 40-pin IDE hard disk cable
- One 34-pin floppy disk drive cable
- One CD

If any of these items are missing or damaged, please contact your dealer or sales representative for assistance.

Chapter 2 - Hardware Installation

Installation du Matériel

Installation der Hardware

2.1 System Board Layout

Position de la Carte Système

Aufbau der Hauptplatine

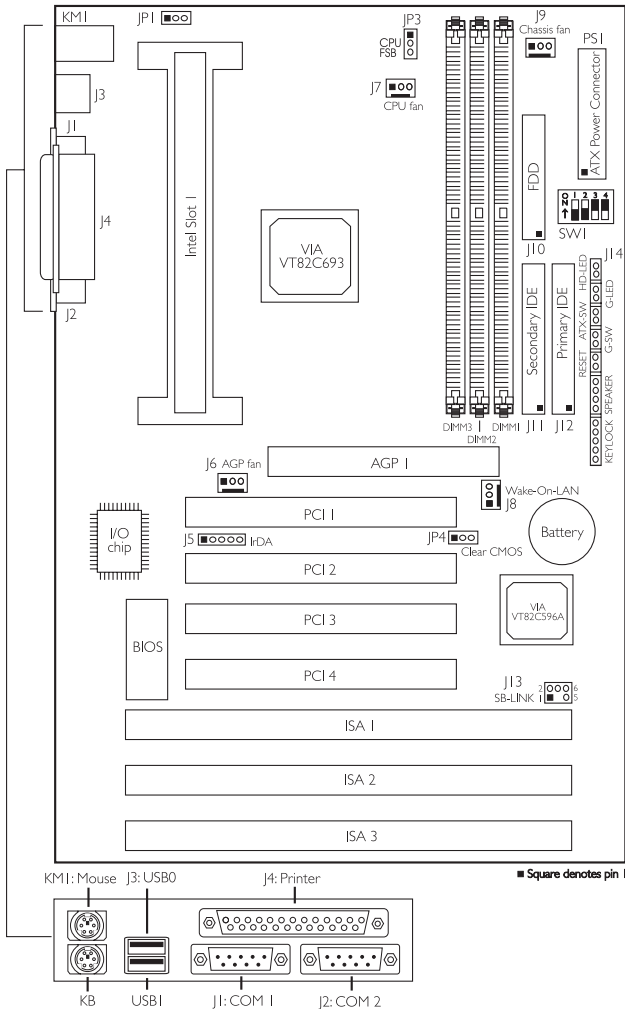

2.2 DIP Switch Settings of the Processors Positionnement des Cavaliers des Processeurs DIP Schaltereinstellungen für den Prozessor

The table below shows the supported processors and their corresponding DIP switch settings.

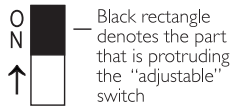

In the example above:

- Switch 1: Off
- Switch 2: Off
- Switch 3: On
- Switch 4: On

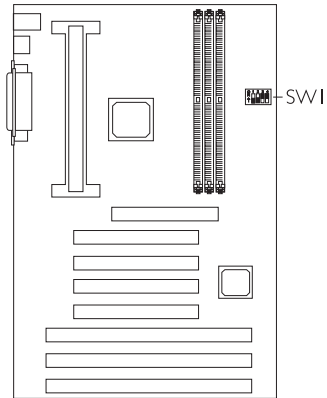

Processor		Frequency Ratio	SW1	Processor		Frequency Ratio	SW1
66MHz	100MHz			66MHz	100MHz		
233MHz	350MHz	3.5x		400MHz	Future processor	6x	
266MHz	400MHz	4x		433MHz	Future processor	6.5x	
300MHz	450MHz	4.5x		Future processor	Future processor	7x	
333MHz	500MHz	5x		Future processor	Future processor	7.5x	
366MHz	Future processor	5.5x		Future processor	Future processor	8x	



Note:

Intel Pentium® II, Intel Pentium® III processor or Intel Celeron™ (SEPP) processor supports VID (Voltage Identification). The switching voltage regulator on the system board will automatically set the voltage regulator according to the voltage of the processor.

2.3 Jumper Settings for the CPU's Front Side Bus

Positionnement des cavaliers pour le bus frontal du processeur

Jumpereinstellungen fuer CPU Vorderseitenbus

Jumper JP3
CPU's Front Side Bus Select

The default setting of jumper JP3 is Auto - the system will automatically run according to the FSB of the processor. If you wish to overclock a 66MHz FSB processor to 100MHz, set pins 1, 2 and 3 to Off. If you want a 100MHz FSB processor to run at 66MHz, set pins 2 and 3 to On. Refer to the figure below.

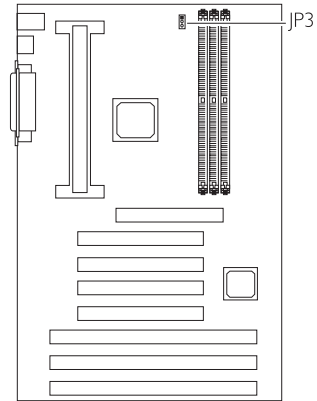

Warning:

Overclocking a 66MHz FSB processor to 100MHz will provide better system performance. However, not all 66MHz FSB processors are capable of running at 100MHz bus speed. Therefore, if you are unable to boot your system when set at 100MHz, make sure to set JP3 back to its default setting.



1-2 On: Auto
(default)



2-3 On: 66MHz



1-2-3 Off: 100MHz

2.4 Jumper Settings for Clearing CMOS Data

Positionnement des Cavaliers pour Effacer les Données CMOS

Jumpereinstellungen zum Löschen der CMOS Daten

Jumper JP4 - CMOS Clear

To load the default values stored in the ROM BIOS, please follow the steps below.

1. **Power-off the system and unplug the power cord.**
2. Set JP4 pins 2 and 3 to On. Wait for a few seconds and set JP4 back to its default setting, pins 1 and 2 On.
3. Plug the power cord and power-on the system.

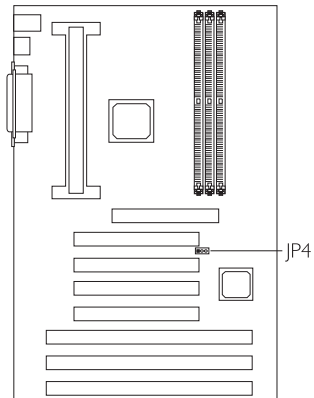
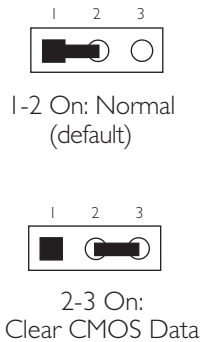

2.5 Jumper Settings for Wake-On-Keyboard/Mouse

Positionnement des Cavaliers pour Réveil-Sur-Clavier/Souris

Jumpereinstellungen für die Wake-On Tastatur/Maus

Jumper JPI - Wake-on-Keyboard/Mouse

To use the keyboard or mouse to power-on the system, please follow the steps below.

1. Set JPI to 2-3 On, enable.
2. "Keyboard/Mouse Power On" in the Integrated Peripherals setup of the Award BIOS must be set accordingly. Refer to section 3.10 (chapter 3) for more information.

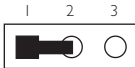
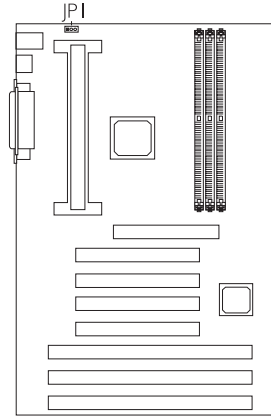

1-2 On: Disable
(default)

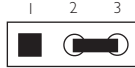

2-3 On: Enable



Warning:

1. If JPI was previously enabled with a password set in the "KB Power On Password" field, and now you wish to disable the Wake-On-Keyboard (password) function, make sure to set the "Keyboard/Mouse Power On" field to Disabled prior to setting JPI to disabled. You will not be able to boot up the system if you fail to do so.
2. The power button will not function once a keyboard password has been set in the "KB Power On Password" field of the Integrated Peripherals setup. You must type the password to power-on the system.
3. The 5VSB power source of your power supply must support $\geq 720\text{mA}$ (minimum).

2.6 Connectors / Connecteurs / Anschlüsse

2.6.1 Floppy Disk Drive Controller and IDE Interface Contrôleur de Lecteur de Disquette et Interface IDE Diskettenlaufwerkcontroller und IDE Interface

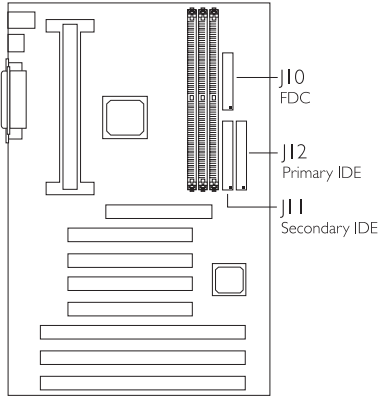

Important:

If you encountered problems while using an ATAPI CD-ROM drive that is set in Master mode, please set the CD-ROM drive to Slave mode. Some ATAPI CD-ROMs may not be recognized and cannot be used if incorrectly set in Master mode.

2.6.2 IrDA Connector Connecteur IrDA IrDA Anschlüsse

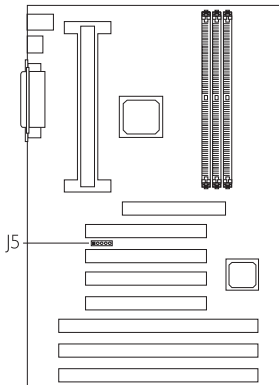

Pin	Function
1	IRTX
2	GND
3	IRRX
4	N. C.
5	VCC



2.6.3 CPU Fan Connector

Connecteur du Ventilateur de CPU

CPU Kühlung Anschluß

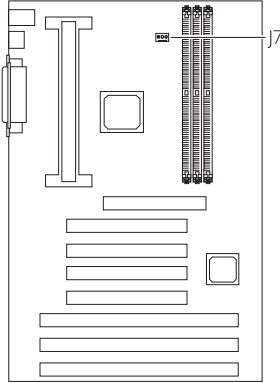

Pin	Function
1	On/Off
2	+12V
3	Sense

2.6.4 Chassis Fan Connector

Connecteur de Châssis de Ventilateur

Anschluß Kühlungsgehäuse

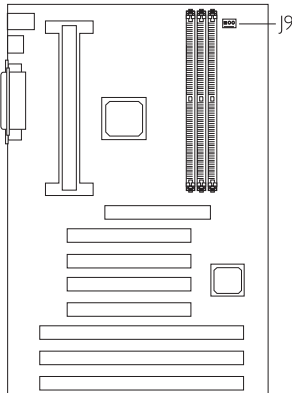

Pin	Function
1	On/off
2	+12V
3	Sense

2.6.5 AGP Fan Connector Connecteur de Ventilateur AGP Anschluß AGP Kühlung

Pin	Function
1	GND
2	+12V
3	N. C.

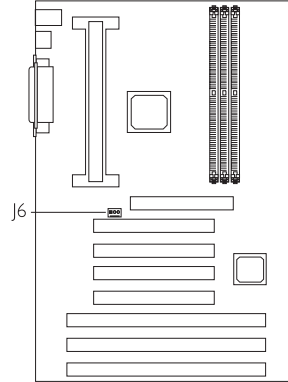

2.6.6 Wake-On-LAN (WOL) Connector Connecteur Réveil-Sur-LAN (WOL) Wake-On-LAN (WOL) Anschluß

Pin	Function
1	5VSB (720mA)
2	GND
3	WOL

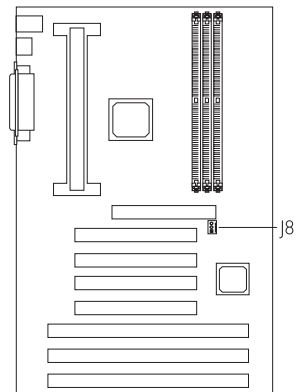

Important:

The 5VSB power source of your power supply must support $\geq 720\text{mA}$ (minimum).

2.6.7 SB-LINK Connector Connecteur de SB-LINK Anschluß SB-LINK

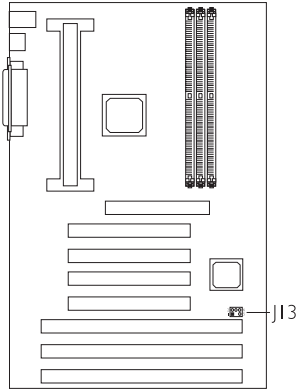

Pin	Function
1	PC-PCI-GNTx
2	DGND
3	Key
4	PC-PCI-REQx
5	DGND
6	SERIRQ

2.6.8 LEDs and Switches Commutateurs et LED LEDs und Schalter

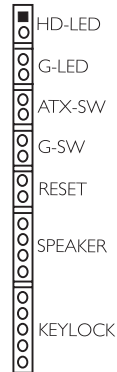
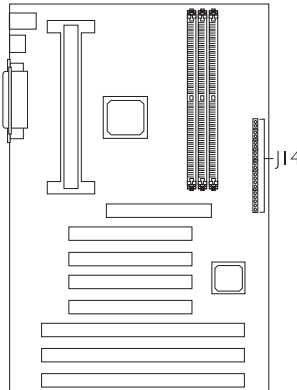

	Pin	Pin Assignment
HD-LED (Primary/Secondary IDE LED)	1	HDD LED Power
	2	HDD
	3	N. C.
G-LED (Green LED)	4	Green LED Power
	5	Green
	6	N. C.
ATX-SW (ATX power switch)	7	PWRBT
	8	Ground
	9	N. C.
G-SW (Green switch)	10	SMI
	11	Ground
	12	N. C.
RESET (Reset switch)	13	H/W Reset
	14	Ground
	15	N. C.
SPEAKER (Speaker connector)	16	Speaker Data
	17	N. C.
	18	Ground
	19	Speaker Power
	20	N. C.
KEYLOCK (Keylock and Power LED connector)	21	LED Power
	22	N. C.
	23	Standby Signal
	24	Keylock
	25	Ground
		Use pins 21 to 23 for the Power/ Standby LED.



Important:

ATX-SW (ATX Power Switch) - Depending on the setting in the BIOS setup, this switch is a “dual function power button” that will allow your system to enter the Soft-Off or Suspend mode. Refer to section 3.7 (chapter 3) for more information.

2.6.9 Power Connector Connecteur d'Alimentation Netzanschluß

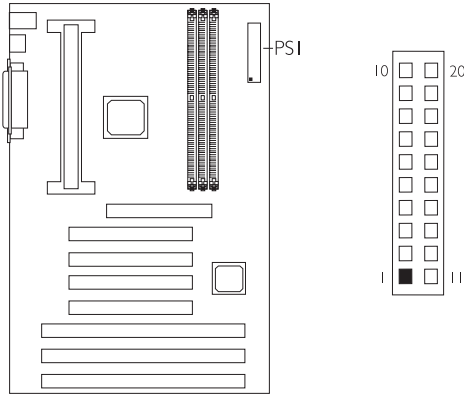

PS1 connector's pin assignment.

Pin	Function	Pin	Function
1	3.3V/14A	11	3.3V/14A
2	3.3V/14A	12	-12V
3	COM	13	COM
4	+5V	14	PS-ON
5	COM	15	COM
6	+5V	16	COM
7	COM	17	COM
8	PW-OK	18	-5V
9	5VSB	19	+5V
10	+12V	20	+5V



Important:

Your power supply must meet the ATX specification - supporting 3.3V/14A (minimum), otherwise your system will not boot properly.

Chapter 3 - Award BIOS Setup Utility

Utilitaire de Configuration du Award BIOS AWARD BIOS Konfigurationsprogramm

3.1 Entering the Award BIOS Setup Utility

Entrer Dans l'Utilitaire de Configuration du Award BIOS Aufruf des AWARD BIOS Konfigurationsprogramms

Power-on the system and press to enter the utility. The main program screen will appear:

Allumez le Système et appuyez sur pour entrer dans l'utilitaire. L'écran du programme principal apparaîtra.

Zum Aufrufen des Konfigurationsprogramms drücken Sie während des Startvorgangs die Taste . Ein Bildschirm ähnlich dem folgenden erscheint.

ROM PCI/ISA BIOS
CMOS SETUP UTILITY
AWARD SOFTWARE, INC.

STANDARD CMOS SETUP BIOS FEATURES SETUP CHIPSET FEATURES SETUP POWER MANAGEMENT SETUP PNP/PCI CONFIGURATION LOAD FAIL-SAFE SETTINGS LOAD OPTIMAL SETTINGS	INTEGRATED PERIPHERALS SUPERVISOR PASSWORD USER PASSWORD IDE HDD AUTO DETECTION SAVE & EXIT SETUP EXIT WITHOUT SAVING
Esc : Quit F10 : Save & Exit Setup	↑↓→← : Select Item (Shift) F2 : Change Color

3.2 Setting the Date and Time

Paramétrage de la Date et de l'Heure

Einstellen des Datums und der Zeit

ROM PCI/ISA BIOS
STANDARD CMOS SETUP
AWARD SOFTWARE, INC.

Date (mm:dd:yy) : Fri, Nov 27 1998									
Time (hh:mm:ss) : 13:27:50									
HARD DISKS	TYPE	SIZE	CYLS	HEAD	PRECOMP	LANDZ	SECTOR	MODE	
Primary Master	: Auto	0	0	0	0	0	0	0	Auto
Primary Slave	: Auto	0	0	0	0	0	0	0	Auto
Secondary Master	: Auto	0	0	0	0	0	0	0	Auto
Secondary Slave	: Auto	0	0	0	0	0	0	0	Auto
Drive A : 1.44M, 3.5 in.									
Drive B : None									
Video : EGA/VGA									
Halt on : All Errors									
					Base Memory : 640K				
					Extended Memory : 64512K				
					Other Memory : 384K				
					Total Memory : 65536K				
Esc : Quit			↑↓→← : Select Item			PU/PD/+/- : Modify			
F10 : Save & Exit Setup			(Shift)F2 : Change						

1. Select "Standard CMOS Setup" in the main program screen and press <Enter>.

Sélectionnez "Standard CMOS Setup" dans l'écran du programme principal et appuyez sur <Entrée>.

"Standard CMOS Setup" in dem Hauptbildschirm auswählen, und die Eingabetaste (Enter) drücken.

2. Set the correct date and time in the "Date" and "Time" fields respectively.

Sélectionnez la date et l'heure correcte dans les champs "Date" et "Time" respectivement.

Jeweils korrekte Werte in die Eingabefelder "Date" (Datum) und "Time" (Zeit) eingeben.

3.3 Selecting the Hard Drive and Floppy Drive Type

Sélectionnez le Type de Disque Dur et de Lecteur de Disquette

Auswahl der Festplatte und des Diskettenlaufwerks

ROM PCI/ISA BIOS
STANDARD CMOS SETUP
AWARD SOFTWARE, INC.

Date (mm:dd:yy) : Fri, Nov 27 1998								
Time (hh:mm:ss) : 13: 27: 50								
HARD DISKS	TYPE	SIZE	CYLS	HEAD	PRECOMP	LANDZ	SECTOR	MODE
Primary Master	: Auto	0	0	0	0	0	0	Auto
Primary Slave	: Auto	0	0	0	0	0	0	Auto
Secondary Master	: Auto	0	0	0	0	0	0	Auto
Secondary Slave	: Auto	0	0	0	0	0	0	Auto
Drive A : 1.44M, 3.5 in.								
Drive B : None								
Video : EGA/VGA						Base Memory : 640K		
Halt on : All Errors						Extended Memory : 64512K		
						Other Memory : 384K		
						Total Memory : 65536K		
Esc : Quit			↑↓→← : Select Item			PU/PD/+/- : Modify		
F10 : Save & Exit Setup			(Shift)F2 : Change					

1. Select "Standard CMOS Setup" in the main program screen and press <Enter>.

Sélectionnez "Standard CMOS Setup" dans l'écran du programme principal et appuyez sur <Entrée>.

"Standard CMOS Setup" in dem Hauptbildschirm auswählen, und die Eingabetaste (Enter) drücken.

2. Select "Auto" for the hard disk drive(s) installed in your system. The BIOS will auto-detect the HDD & CD-ROM drive at the POST stage and show the IDE for the HDD & CD-ROM drive. If a hard disk has not been installed, select "None" and press <Enter>.

Sélectionnez "Auto" pour le(s) disque(s) dur(s) installés dans votre système. Le BIOS détectera automatiquement le Disque Dur et le Lecteur CD-ROM durant la phase POST et affichera l'IDE du Disque Dur et du Lecteur CD-ROM. Si aucun disque dur n'a été installé, sélectionnez "None" et appuyez sur <entrée>.

Im Eintrag "Hard Disk Drive(s)" (Festplatte) "Auto" auswählen. Das Programm entdeckt die Festplatte sowie das CD-ROM Laufwerk während der Initialisierung automatisch. Ist keine Festplatte installiert, aktivieren Sie den Eintrag "None". Eingabetaste (Enter) drücken.

- Set the type of floppy drive installed in the "Drive A" and "Drive B" fields. The options are None, 360K, 1.2M, 720K, 1.44M and 2.88M.

Paramétrez le type de lecteur de disquette installé dans les champs "Drive A" et "Drive B". Les options sont None, 360K, 1.2M, 720K, 1.44M et 2.88M.

Im Eintrag "Floppy Drive" (Diskettenlaufwerk) wählen Sie "Drive A" (Laufwerk A) und "Drive B" (Laufwerk B). Die Optionen sind None (Kein), 360K, 1.2M, 720K, 1.44M und 2.88M.

3.4 Selecting the Drive to be Searched First for an Operating System

Sélectionner le Lecteur qui doit être Détecté en premier par un Système d'Exploitation

Auswahl des Bootlaufwerks

ROM PCI/ISA BIOS BIOS FEATURES SETUP AWARD SOFTWARE, INC.	
Virus Warning	: Disabled
CPU L1 Cache	: Enabled
CPU L2 Cache	: Enabled
CPU L2 Cache ECC Checking	: Enabled
Quick Power On Self Test	: Enabled
Boot Sequence	: A, C, SCSI
Swap Floppy Drive	: Disabled
Boot Up Floppy Seek	: Disabled
Boot Up NumLock Status	: On
DRAM ECC Checking	: Disabled
Typematic Rate Setting	: Disabled
Typematic Rate (Chars/Sec)	: 6
Typematic Delay (Msec)	: 250
Security Option	: Setup
PCI/VGA Palette Snoop	: Disabled
OS Select For DRAM > 64MB	: Non-OS2
HDD S.M.A.R.T. Capability	: Disabled
Processor Serial Number	: Disabled
ESC : Quit ↑↓←→ : Select Item F1 : Help PU/PD/+/- : Modify F5 : Old Values (Shift) F2 : Color F6 : Load Fail-Safe Settings F7 : Load Optimal Settings	

- Select "BIOS Features Setup" in the main program screen and press <Enter>.

Sélectionnez "BIOS Features Setup" dans l'écran de programme principal et appuyez sur <Entrée>.

"BIOS Features Setup" in dem Hauptbildschirm auswählen, und die Eingabetaste (Enter) drücken.

- Select the drive to be searched first in the "Boot Sequence" field. The default is A, C, SCSI. The other options are: C, A, SCSI; C, CDROM, A; CDROM, C, A; D, A, SCSI; E, A, SCSI; F, A, SCSI; SCSI, A, C; SCSI, C, A; C only and LS/ZIP, C.

Sélectionnez le lecteur qui devra être détecté en premier dans le champs "Boot Sequence". La valeur par défaut est A, C, SCSI. Les autres options sont: C, A, SCSI; C, CDROM, A; CDROM, C, A; D, A, SCSI; E, A, SCSI; F, A, SCSI; SCSI, A, C; SCSI, C, A; C seulement et LS/ZIP, C.

Im "Boot Sequence" Feld wählen Sie die Sequenz, in welcher der Computer nach einem Betriebssystem sucht. Die Optionen sind C, A, SCSI; C, CDROM, A; CDROM, C, A; D, A, SCSI; E, A, SCSI; F, A, SCSI; SCSI, A, C; SCSI, C, A; nur C und LS/ZIP, C.

3.5 Setting the Processor Serial Number Function

Activer la Fonction Numéro de Série de Processeur

Aktivieren der Prozessor-Seriennummer Funktion

ROM PCI/ISA BIOS BIOS FEATURES SETUP AWARD SOFTWARE, INC.	
Virus Warning	: Disabled
CPU L1 Cache	: Enabled
CPU L2 Cache	: Enabled
CPU L2 Cache ECC Checking	: Enabled
Quick Power On Self Test	: Enabled
Boot Sequence	: A, C, SCSI
Swap Floppy Drive	: Disabled
Boot Up Floppy Seek	: Disabled
Boot Up NumLock Status	: On
DRAM ECC Checking	: Disabled
Typeomatic Rate Setting	: Disabled
Typeomatic Rate (Chars/Sec)	: 6
Typeomatic Delay (Msec)	: 250
Security Option	: Setup
PCI/VGA Palette Snoop	: Disabled
OS Select For DRAM > 64MB	: Non-OS2
HDD S.M.A.R.T. Capability	: Disabled
Processor Serial Number	: Disabled
ESC : Quit ↑↓←→ : Select Item F1 : Help PU/PD/+/- : Modify F5 : Old Values (Shift) F2 : Color F6 : Load Fail-Safe Settings F7 : Load Optimal Settings	

1. Select "BIOS Features Setup" in the main program screen and press <Enter>.

Sélectionnez "BIOS Features Setup" dans l'écran de programme principal et appuyez sur <Entrée>.

"BIOS Features Setup" in dem Hauptbildschirm auswählen, und die Eingabetaste (Enter) drücken.

2. Select "Processor Serial Number". The options are Disabled and Enabled.

Sélectionnez "Processor Serial Number". Les options sont Disabled et Enabled.

Im "Processor Serial Number" Feld sind folgende Optionen möglich Disabled und Enabled.

This field will appear only when you are using a Pentium® III processor. Each Pentium® III processor comes with an individual "processor serial number" which by default is activated. Therefore, when connected to the Internet, Pentium® III processor transmits the serial number online making it possible to track your online activity. The field provides you the option of disabling this function.

Ce champ apparaît seulement lorsque vous utilisez un Processeur Pentium® III. Chaque processeur Pentium® III est livré avec un "Numéro de Série de Processeur" Individuel qui est activé par défaut. De ce fait, lorsque vous êtes connecté sur Internet, le processeur Pentium® III transmet le numéro de série en ligne rendant possible le dépistage de votre activité en ligne. Dans ce champs vous trouverez l'option pour la désactivation de cette fonction.

Dieses Feld erscheint nur, wenn Sie mit einem Pentium® III Prozessor arbeiten. Jeder Pentium® III Prozessor besitzt eine eigene "Prozessor-Seriennummer", die automatisch aktiviert wird. Daher wird die Seriennummer durch den Pentium® III Prozessor online übertragen, wenn Sie im Internet verbunden sind, damit Sie immer einen Überblick über Ihre Online-Aktivität haben. Mit der Option im Feld kann diese Funktion deaktiviert werden.

3.6 Selecting the External System Bus Clock of the Processor

Paramétrage de l'Horloge Externe de Bus Système du Processeur

Auswahl des externen Systemtaktgebers Ihres Prozessors

ROM PCI/ISA BIOS
CHIPSET FEATURES SETUP
AWARD SOFTWARE, INC.

DIMM 1 DRAM Timing	: Normal	**** System Health Monitor ****
DIMM 2 DRAM Timing	: Normal	Current System Temp. : 28°C/82°F
DIMM 3 DRAM Timing	: Normal	Current CPU Temperature : 42°C/107°F
SDRAM CAS Latency	: 3	Current Chassis FAN Speed : 0 RPM
DRAM Clock	: Host CLK	Current CPU FAN Speed : 4326 RPM
Read Around Write	: Disabled	CPU(V) : 2.00 V
Concurrent PCI/Host	: Disabled	+1.5 V : 1.51 V
CPU to PCI Write Buffer	: Enabled	+3.3 V : 3.40 V
PCI Dynamic Bursting	: Enabled	+5 V : 5.08 V
PCI Master 0 WS Write	: Enabled	+12 V : 12.34 V
PCI Delay Transaction	: Enabled	-12 V : -11.76 V
PCI#2 Access #1 Retry	: Disabled	-5 V : -5.09 V
AGP Master 1 WS Write	: Enabled	
AGP Master 1 WS Read	: Disabled	
Video RAM Cacheable	: Disabled	
Memory Hole At 15M-16M	: Disabled	
AGP Aperture Size <MB>	: 64	
AGP-2X Mode	: Enabled	
CPU/PCI Clock (MHz)	: Default	ESC : Quit ↑ ↓ → ← : Select Item
Spread Spectrum	: Disabled	F1 : Help PU/PD/+/- : Modify
		F5 : Old Values (Shift) F2 : Color
		F6 : Load Fail-Safe Settings
		F7 : Load Optimal Settings

1. Select "Chipset Features Setup" in the main program screen and press <Enter>.

Sélectionnez "Chipset Features Setup" dans l'écran de programme principal et appuyez sur <Entrée>.

"Chipset Features Setup" in dem Hauptbildschirm auswählen, und die Eingabetaste (Enter) drücken.

2. Select the external system bus clock of your processor in the "CPU/PCI Clock (MHz)" field. The options are Default, 66.8/33.4, 75/37.5, 83.3/41.65, 100.3/33.4, 103/34.33, 105/35, 110/36.67, 112/37.33, 115/38.33, 120/40, 124/31, 124/41.33, 133/33.25, 140/35 and 150/37.5. When selecting the external bus clock of your processor, the PCI clock will at the same time appear next to the external bus clock selected. For example, if you selected "66.8/33.4", 66.8MHz is the external bus clock and 33.4MHz is the PCI clock. Regardless of the type of processor used, the default setting is "Default". Under this setting, the system will run according to the processor's clock frequency. If you selected an option other than "Default" and is unable to boot up the system, there are 2 methods of going back to its default setting.

Method 1: Clear the CMOS data by following the procedure in section 2.4 (chapter 2) of this manual. All fields in the BIOS Setup will automatically be set to its default settings.

Method 2: Press the <Insert> key and power button simultaneously, then release the power button first. You must keep-on pressing the <Insert> key until the power-on screen appears. This will allow the system to boot according to the FSB of the processor. Now press the key to enter the Award BIOS setup utility. Select "Chipset Features Setup" and set the "CPU/PCI Clock (MHz)" field to "Default" or an appropriate clock frequency.



Note:

When using a 66MHz FSB processor, the AGP clock and the CPU's external bus clock are similar. When using a 100MHz FSB processor, the AGP clock is 2/3 of the CPU's external bus clock.

Sélectionnez l'Horloge Externe de Bus Système de votre processeur dans le champ "CPU/PCI Clock (MHz)". Les options par Default, 66.8/33.4, 75/37.5, 83.3/41.65, 100.3/33.4, 103/34.33, 105/35, 110/36.67, 112/37.33, 115/38.33, 120/40, 124/31, 124/41.33, 133/33.25, 140/35 et 150/37.5. L'horloge PCI apparaîtra simultanément à côté de l'horloge bus externe en sélectionnant l'horloge bus externe de votre processeur. Si, par exemple, on sélectionne "66.8/33.4", l'horloge bus externe sera 66.8MHz et l'horloge PCI sera 33.4MHz. Indépendamment du type de processeur utilisé, le paramètre par défaut est "Default". Avec ces paramètres, le système fonctionnera d'une manière qui correspond à la fréquence d'horloge du processeur. Si vous sélectionnez une option autre que "Default" et que vous ne puissiez pas amorcer le système, il existe 2 méthodes pour rétablir les paramètres par défaut.

Méthode 1: Effacez les données du CMOS en suivant la procédure décrite dans la Section 2.4 (Chapitre 2) de ce manuel. Tous les champs dans le programme d'installation du BIOS seront positionnés automatiquement à leur valeur par défaut.

Méthode 2: Appuyez sur la touche <Insert> et le bouton de mise sous tension simultanément, puis relâchez tout d'abord le bouton de mise sous tension. Vous devez continuer à appuyer sur la touche <Insert> jusqu'à ce que l'écran de mise en route apparaisse. Ceci permettra au système de redémarrer en fonction du FSB du processeur. Maintenant appuyez sur la touche afin d'entrer dans l'utilitaire d'installation du Award BIOS. Sélectionnez "Chipset Features Setup" et positionnez le champ "CPU/PCI Clock (MHz)" sur "Default" ou sur la fréquence d'horloge qui convient.



Note:

L'horloge AGP et l'horloge bus externe du CPU sont presque pareilles en utilisant un processeur FSB à 66MHz. Si on travaille avec un processeur FSB à 100MHz, l'horloge AGP sera 2/3 de l'horloge bus externe du CPU.

Im "CPU/PCI Clock (MHz)" Feld sind folgende. Sind die Optionen Default, 66.8/33.4, 75/37.5, 83.3/41.65, 100.3/33.4, 103/34.33, 105/35, 110/36.67, 112/37.33, 115/38.33, 120/40, 124/31, 124/41.33, 133/33.25, 140/35 und 150/37.5. Beim Auswählen des externen Bus-Taktgebers Ihres Prozessors erscheint der PCI-Taktgeber gleichzeitig neben dem ausgewählten externen Bus-Taktgeber. Wählen Sie beispielsweise "66.8/33.4" aus, beträgt der externe Bus-Taktgeber 66.8MHz und der PCI-Taktgeber 33.4MHz. Die Standardeinstellung ist auf "Default" eingestellt, ungeachtet des Prozessortyps, mit dem Sie arbeiten. Bei dieser Einstellung funktioniert das System gemäß der Taktfrequenz des Prozessors. Wählen Sie eine andere Option als "Default" aus und das System kann damit nicht gestartet werden, gibt es zwei Methoden, die Standardeinstellung wiederherzustellen.

Methode 1: Die CMOS-Daten müssen durch Befolgen des in Abschnitt 2.4 (Kapitel 2) in diesem Handbuch beschriebenen Vorgangs gelöscht werden. Sämtliche Bereiche im BIOS-Setup werden dann automatisch auf ihre Standardeinstellung eingestellt.

Methode 2: Die Taste <Insert> und die Netztaaste gleichzeitig drücken. Dann zuerst die Netztaaste loslassen, aber die Taste <Insert> solange gedrückt halten, bis der Einschalt-Schirm erscheint. Dies ermöglicht ein Starten des Systems gemäß dem FSB des Prozessors. Zum Aktivieren des Dienstprogramms des Award-BIOS-Setup muß die -Taste gedrückt werden. Dann "Chipset Features Setup" auswählen und die "CPU/PCI Clock (MHz)" auf "Default" pder eine geeignete Taktfrequenz einstellen.

**Hinweis:**

Beim Betrieb mit einem 66MHz-FSB-Prozessor sind der AGP-Taktgeber und der externe Bus-Taktgeber des CPUs ähnlich. Der AGP-Taktgeber beträgt 2/3 des externen Bus-Taktgebers des CPUs, falls ein 100MHz-FSB-Prozessor verwendet wird.

3.7 Selecting the Method of Powering-off the System Sélection de la Méthode pour Eteindre le Système Auswahl der Abschaltmethode

ROM PCI/ISA BIOS POWER MANAGEMENT SETUP AWARD SOFTWARE, INC.			
ACPI Function	: Disabled	** PM Events **	
Power Management	: User Define	IRQ3 (COM 2)	: Primary
PM Control by APM	: Yes	IRQ4 (COM 1)	: Primary
Video Off Method	: DPMS	IRQ5 (LPT 2)	: Primary
Video Off After	: Suspend	IRQ6 (Floppy Disk)	: Primary
Standby Mode	: Disabled	IRQ7 (LPT 1)	: Primary
Suspend Mode	: Disabled	IRQ8 (RTC Alarm)	: Disabled
HDD Power Down	: Disabled	IRQ9 (IRQ2 Redir)	: Secondary
Soft-Off by PWR-BTTN	: Instant-Off	IRQ10 (Reserved)	: Secondary
PWR Lost Resume State	: Keep Off	IRQ11 (Reserved)	: Secondary
Resume on Ring	: Disabled	IRQ12 (PS/2 Mouse)	: Secondary
Resume on LAN	: Disabled	IRQ13 (Coprocessor)	: Primary
Resume on Alarm	: Disabled	IRQ14 (Hard Disk)	: Primary
		IRQ15 (Reserved)	: Disabled
		ESC	: Quit ↑ ↓ → ← : Select Item
		F1	: Help PU/PD/+/- : Modify
		F5	: Old Values (Shift) F2 : Color
		F6	: Load Fail-Safe Settings
		F7	: Load Optimal Settings

1. Select "Power Management Setup" in the main program screen and press <Enter>.

Sélectionnez "Power Management Setup" dans l'écran de programme principal et appuyez sur <Entrée>.

"Power Management Setup" in dem Hauptbildschirm auswählen, und die Eingabetaste (Enter) drücken.

2. Select the method of powering-off the system in the "Soft-Off by PWR-BTTN" field. The options are Hold 4 Sec. and Instant-Off.

Sélectionnez la Méthode pour éteindre le système dans le champ "Soft-Off by PWR-BTTN". Les options sont Hold 4 Sec. et Instant-Off.

In dem Feld "Soft-Off by PWR-BTTN" können Sie die Methode bestimmen, mit welcher Ihr Rechner ausgeschaltet wird. Die Optionen sind Hold 4 Sec. (4 Sekunden warten) und Instant-Off (Direktabschaltung).

Hold 4 Sec. If the power button is pushed and released in less than 4 seconds, the system enters the Suspend mode. Push and release it again in less than 4 seconds to restore. Pushing the power button for more than 4 seconds will power-off the system.

Si le bouton de mise sous tension est poussé puis relâché en moins de 4 secondes, le système entrera en mode suspend. Poussez le et relâchez le à nouveau en moins de 4 secondes pour restaurer la fonction. Le fait d'appuyer sur le bouton de mise sous tension pendant plus de 4 secondes éteindra le système.

Wird die Netztaete gedrückt und innerhalb von 4 Sekunden wieder losgelassen, schaltet sich das System in den Suspend-Modus. Ein erneutes Drücken mit einem Loslassen innerhalb von 4 Sekunden stellt den Normalzustand wieder her. Wird die Netztaete für die Dauer von über 4 Sekunden gedrückt gehalten, schaltet sich das System ab.

Instant-Off Pressing and then releasing the power button at once will immediately power-off the system.

Le fait d'appuyer sur le bouton de mise sous tension en une fois éteindra le système immédiatement.

Normales Drücken der Netztaete schaltet das System augenblicklich ab.

3.8 Selecting the Power Lost Resume State

Choisir l'état de Redémarrage Après Coupure de Courant

Auswählen des "PWR Lost Resume" Status

ROM PCI/ISA BIOS
POWER MANAGEMENT SETUP
AWARD SOFTWARE, INC.

ACPI Function	: Disabled	** PM Events **	
Power Management	: User Define	IRQ3 (COM 2)	: Primary
PM Control by APM	: Yes	IRQ4 (COM 1)	: Primary
Video Off Method	: DPMS	IRQ5 (LPT 2)	: Primary
Video Off After	: Suspend	IRQ6 (Floppy Disk)	: Primary
Standby Mode	: Disabled	IRQ7 (LPT 1)	: Primary
Suspend Mode	: Disabled	IRQ8 (RTC Alarm)	: Disabled
HDD Power Down	: Disabled	IRQ9 (IRQ2 Redir)	: Secondary
Soft-Off by PWR-BTTN	: Instant-Off	IRQ10 (Reserved)	: Secondary
PWR Lost Resume State	: Keep Off	IRQ11 (Reserved)	: Secondary
Resume on Ring	: Disabled	IRQ12 (PS/2 Mouse)	: Secondary
Resume on LAN	: Disabled	IRQ13 (Coprocessor)	: Primary
Resume on Alarm	: Disabled	IRQ14 (Hard Disk)	: Primary
		IRQ15 (Reserved)	: Disabled
		ESC : Quit	↑ ↓ → ← : Select Item
		F1 : Help	PU/PD +/- : Modify
		F5 : Old Values (Shift) F2 : Color	
		F6 : Load Fail-Safe Settings	
		F7 : Load Optimal Settings	

1. Select "Power Management Setup" in the main program screen and press <Enter>.

Sélectionnez "Power Management Setup" dans l'écran de programme principal et appuyez sur <Entrée>.

"Power Management Setup" in dem Hauptbildschirm auswählen, und die Eingabetaste (Enter) drücken.

2. Select the "PWR Lost Resume State" field. The options are:

Sélectionnez "PWR Lost Resume State". Les options sont

In dem Feld "PWR Lost Resume State". Die Optionen sind:

Keep Off When power returns after an AC power failure, you must press the Power button to power-on the system.

Quand le courant revient après une coupure, vous devez appuyer sur le bouton d'alimentation pour redémarrer le système.

Wenn die Leistung nach einem AC-Leistungsfehler zurueckkehrt, muessen Sie den Ein-/Ausschalter druecken, um das System zu starten.

Turn On When power returns after an AC power failure, the system will automatically power-on.

Quand le courant revient après une coupure, le système redémarre automatiquement.

Wenn die Leistung nach einem AC-Leistungsfehler zurueckkehrt, wird das System automatisch gestartet.

Last State When power returns after an AC power failure, the operating session where you left off before power failure occurs will resume.

Quand le courant revient après une coupure, la session va recommencer là où vous étiez avant la coupure.

Wenn die Leistung nach einem AC-Leistungsfehler zurueckkehrt, wird der Betrieb dort wieder aufgenommen, wo Sie waren, bevor der Leistungsfehler aufgetreten ist.

3.9 Using the System Health Monitor Function

Utilisez de System Health Monitor

Arbeiten der System Health Monitor

ROM PCI/ISA BIOS
CHIPSET FEATURES SETUP
AWARD SOFTWARE, INC.

DIMM 1 DRAM Timing	: Normal	**** System Health Monitor ****
DIMM 2 DRAM Timing	: Normal	Current System Temp. : 28°C/82°F
DIMM 3 DRAM Timing	: Normal	Current CPU Temperature : 42°C/107°F
SDRAM CAS Latency	: 3	Current Chassis FAN Speed : 0 RPM
DRAM Clock	: Host CLK	Current CPU FAN Speed : 4326 RPM
Read Around Write	: Disabled	CPU(V) : 2.00 V
Concurrent PCI/Host	: Disabled	+1.5 V : 1.51 V
CPU to PCI Write Buffer	: Enabled	+3.3 V : 3.40 V
PCI Dynamic Bursting	: Enabled	+5 V : 5.08 V
PCI Master 0 WS Write	: Enabled	+12 V : 12.34 V
PCI Delay Transaction	: Enabled	-12 V : -11.76 V
PCI#2 Access #1 Retry	: Disabled	-5 V : -5.09 V
AGP Master 1 WS Write	: Enabled	
AGP Master 1 WS Read	: Disabled	
Video RAM Cacheable	: Disabled	
Memory Hole At 15M-16M	: Disabled	
AGP Aperture Size <MB>	: 64	
AGP-2X Mode	: Enabled	ESC : Quit ↑ ↓ → ← : Select Item
CPU Clock Frequency	: Default	F1 : Help PU/PD/+/- : Modify
Spread Spectrum	: Disabled	F5 : Old Values (Shift) F2 : Color
		F6 : Load Fail-Safe Settings
		F7 : Load Optimal Settings

1. Select "Chipset Features Setup" in the main program screen and press <Enter>.

Sélectionnez "Chipset Features Setup" dans l'écran de programme principal et appuyez sur <Entrée>.

"Chipset Features Setup" in dem Hauptbildschirm auswählen, und die Eingabetaste (Enter) drücken.

2. System Health Monitor

- Current System Temperature, Current CPU Temperature, Current Chassis Fan Speed and Current CPU Fan Speed

These fields show the internal temperature of the system, current temperature of the processor, and the current fan speed of the chassis and CPU fans in RPM (Revolutions Per Minute).

Ces champs montrent la température interne du système, la température actuelle du processeur, et la vitesse actuelle des ventilateurs de châssis et de CPU en RPM (Rotations Par Minute).

Diese Felder zeigen die Innentemperatur des Systems, die gegenwärtige Temperatur des Prozessors und die gegenwärtige Geschwindigkeit des Lüfters der Chassis und der CPU-Lüfter in UPM (Umdrehungen pro Minute) an.

- CPU(V)

This field shows the voltage of the processor:

Ce champ montre le voltage du processeur:

Dieses Feld zeigt die Spannung des Prozessors an.

- +1.5V, +3.3V, +5V, +12V, -12V and -5V

These fields show the output voltage of the power supply:

Ces champs montrent le voltage de sortie de l'alimentation.

Diese Felder zeigen die Ausgangsspannung der Stromversorgung an.

Hardware Doctor Utility

The system board package comes with a Hardware Doctor utility.

La carte système est fournie avec une utilitaire de Hardware Doctor.

Die System-Platine wird mit einem Hardware Doctor geliefert.



The BIOS is capable of monitoring the system's "health" conditions everytime you boot the system. If it detected an abnormal condition during POST (such as when the temperature of the processor is too high or the speed of the fan is too slow), a warning message will appear BUT no alarm will sound. If you want a warning alarm to sound, you must install the Hardware Doctor utility. This utility, which is included in the provided CD, will allow you to enable the warning alarm and manually set the highest and lowest limit of the "health" conditions monitored by the utility. Once the utility is installed, the system will ignore the settings in this section (System Health Monitor) of the setup. If you are using Windows® 95/98, you may select between using the utility and this setup. For other operating systems, you may only use this setup.

Le BIOS est capable de superviser l'état de "santé" du système chaque fois que vous amorcez le système. Si un état anormal est détecté pendant le POST (comme une température de processeur trop élevée ou une vitesse de ventilateur trop lente), un message d'avertissement apparaîtra, MAIS aucune alarme ne retentira. Si vous voulez qu'une alarme retentisse, vous devez installer l'utilitaire Hardware Doctor. Cet utilitaire, qui est inclus dans le CD fourni, vous permettra d'activer une alarme et de paramétrer manuellement la limite supérieure et inférieure de l'état de «santé» supervisé par l'utilitaire. Une fois que l'utilitaire est installé, le système ignorera les paramètres contenus dans cette section (Superviseur de Santé Système - System Health Monitor) du paramétrage d'installation. Si vous utilisez Windows® 95/98, vous devrez choisir entre l'utilitaire et le paramétrage d'installation. Pour les autres systèmes d'exploitation, vous ne pourrez utiliser, peut-être, seulement ce paramétrage.

Bei jedem Starten des Systems kann der "Gesundheitszustand" des Systems durch das BIOS überwacht werden. Wird während dem POST ein abnormaler Zustand festgestellt (beispielsweise eine zu hohe Temperatur des Prozessors oder eine zu niedrige Geschwindigkeit des Lüfters), erscheint ein Warnhinweis, jedoch KEIN akustisches Signal wird abgegeben. Soll ein akustisches Signal ertönen, muß das Hardware-Doctor-Dienstprogramm installiert werden, das Sie auf der mitgelieferten CD finden. Mit diesem Dienstprogramm kann das akustische Warnsignal aktiviert und die oberste und niedrigste Grenze der durch das Dienstprogramm überwachten "Gesundheitszustände" von Hand eingestellt werden. Nach dem Installieren des Dienstprogramms werden die Einstellungen in diesem Teil Überwachung des

Systemzustands) der Konfiguration durch das System ignoriert. Falls Sie unter Windows® 95/98 arbeiten, können Sie zwischen der Anwendung dieses Dienstprogramms und der Konfiguration auswählen.

3.10 Setting the Wake-On-Keyboard/Mouse Function Activer la Fonction Réveil-Sur-Clavier/Souris Aktivieren der Wake-On Tastatur/Maus Funktion

ROM PCI/ISA BIOS INTEGRATED PERIPHERALS AWARD SOFTWARE, INC.			
Onboard Primary PCI IDE	: Enabled	KBC Input Clock	: 8MHz
Onboard Secondary PCI IDE	: Enabled	Onboard FDC Controller	: Enabled
IDE Prefetch Mode	: Enabled	Onboard Serial Port 1	: 3F8/IRQ4
IDE HDD Block Mode	: Enabled	Onboard Serial Port 2	: 2F8/IRQ3
IDE Primary Master PIO	: Auto	UART2 Mode Select	: Normal
IDE Primary Slave PIO	: Auto		
IDE Secondary Master PIO	: Auto	Onboard Parallel Port	: 378/IRQ7
IDE Secondary Slave PIO	: Auto	Parallel Port Mode	: ECP+EPP
IDE Primary Master UDMA	: Auto	ECP Mode Use DMA	: 3
IDE Primary Slave UDMA	: Auto	EPP Mode Select	: EPP1,7
IDE Secondary Master UDMA	: Auto	Keyboard/Mouse Power On	: Disabled
IDE Secondary Slave UDMA	: Auto		
Init Display First	: AGP	ESC : Quit	↑ ↓ → ← : Select Item
USB Controller	: Enabled	F1 : Help	PU/PD +/- : Modify
USB Keyboard Support	: Disabled	F5 : Old Values (Shift) F2 : Color	
		F6 : Load Fail-Safe Settings	
		F7 : Load Optimal Settings	

- Select "Integrated Peripherals" in the main program screen and press <Enter>.

Sélectionnez "Integrated Peripherals" dans l'écran de programme principal et appuyez sur <Entrée>.

"Integrated Peripherals" in dem Hauptbildschirm auswählen, und die Eingabetaste (Enter) drücken.

- Select "Keyboard/Mouse Power On". The options are:

Sélectionnez "Keyboard/Mouse Power On". Les options sont:

Im "Keyboard/Mouse Power On" Feld sind folgende Optionen möglich:

Disabled Default setting / Valeur par défaut / Voreinstellung.



Warning / Attention / Warnung:

If JPI was previously enabled with a password set in the "KB Power On Password" field, and now you wish to disable the Wake-On-Keyboard (password) function, make sure to

set this field to disabled prior to setting JPI to disabled (1-2 On). You will not be able to boot up the system if you fail to do so.

Si JPI a été activé précédemment avec un mot de passe paramétré dans le "KB Power On Password", et que vous désiriez maintenant désactiver la fonction de Réveil par Clavier (mot de passe), assurez-vous de positionner le champ sur désactivé avant de positionner JPI sur désactivé (1-2 Sélectionné). Si vous ne procédez pas ainsi, vous ne pourrez pas amorcer le système.

Falls JPI zuvor mit einem Kennwort im Feld "KB Power On Password" aktiviert worden ist und Sie nun die Funktion Wake-On-Keyboard (Kennwort) deaktivieren wollen, muß dieses Feld auf Deaktiviert eingestellt werden, bevor JPI auf Deaktiviert (1-2 Ein) eingestellt wird, da sonst das System nicht gestartet werden kann.

Password When this option is selected, the "KB Power On Password" field will appear. Move the cursor to this field and press <Enter>. Enter your password. You can enter up to 5 characters. Type in exactly the same password to confirm, then press <Enter>.

Quand cette option est sélectionnée, la rubrique "KB Power On Password" apparaîtra. Déplacez votre curseur dans cette rubrique et appuyez sur Entrée. Entrez votre mot de passe. Vous pouvez entrer jusqu'à 5 caractères. Tapez exactement le même mot de passe pour confirmer et appuyez sur Entrée.

Wenn diese Option gewählt wird, wird das "KB Power On Password"-Feld erscheinen. Bewegen Sie den Cursor auf dieses Feld und drücken Sie <Enter>. Geben Sie Ihr Passwort ein. Sie koennen bis zu 5 Zeichen eingeben. Tippen Sie nocheinmal genau dasselbe Passwort ein, um dieses zu bestaetigen und druecken Sie dann <Enter>.



Important / Important / Wichtig:

The power button will not function once a keyboard password has been set in the "KB Power On Password" field. You must type the correct password to power-on the system.

Le bouton de mise sous tension ne fonctionnera plus une fois qu'un mot de passe aura été entré dans le champ "KB Power On Password". Vous devez taper le mot de passe correct pour allumer votre système.

Nach dem Einstellen eines Tastatur-Kennwortes im Feld "KB Power On Password" wird die Netztaete nicht funktionieren. Zum Einschalten des Systems muß das richtige Kennwort eingegeben werden.

Hot Key When this option is selected, the "KB Power On Hot Key" field will appear. Move the cursor to this field to select a function key you would like to use to power-on the system. The options are from Ctrl-F1 to Ctrl-F12.

Quand cette option est choisie, la rubrique "KB Power On Hot Key" apparaîtra. Déplacez le curseur dans cette rubrique pour sélectionner la touche de fonction que vous souhaitez utiliser pour allumer le système. Les options vont de Ctrl-F1 à Ctrl-F12.

Wenn diese Option gewaehlt wird, wird das Feld fuer die "KB Power On Hot Key" fuer den Start des Computers erscheinen. Bewegen Sie die Maus auf dieses Feld um eine Tastenkombination zu waehlen, mit der Sie das System starten moechten. Die Optionen sind Ctrl-F1 bis Ctrl-F12.

Mouse Left When this option is selected, double-click the left button of the mouse to power-on the system.

Quand cette option est choisie, double-cliquez sur le bouton gauche de la souris pour allumer le système.

Wenn diese Option gewaehlt wird, druecken Sie zweimal die linke Maustaste, um das System zu starten.

Mouse Right When this option is selected, double-click the right button of the mouse to power-on the system.

Quand cette option est choisie, double-cliquez sur le bouton droit de la souris pour allumer le système.

Wenn diese Option gewaehlt wird, druecken Sie zweimal die rechte Maustaste, um das System zu starten.

Any Key You can press any key to power-on the system.

Vous pouvez appuyez sur n'importe quelle touche pour allumer le système.

Sie koennen jede Taste druecken, um das System zu starten.

Keyboard 98 When this option is selected, press the "wake up" key of the Windows® 98 compatible keyboard to power-on the system.

Quand cette option est sélectionnée, appuyez sur la touche "Réveil" du clavier compatible Windows® 98 pour activer le système.

Wenn diese Option gewählt wurde, drücken Sie die "Aufweck"-Taste der mit dem Windows® 98 kompatiblen Tastatur, um das System einzuschalten.



Important / Important / Wichtig:

Make sure JPI is set to 2-3 On. Refer to "Jumper Settings for Wake-On-Keyboard/Wake-On-Mouse" in Chapter 2 of this manual for more information.

Assurez vous que JPI est positionné sur la sélection 2-3. Pour plus de renseignements, reportez-vous à "Positionnement des Cavaliers pour Réveil-Sur-Clavier/Souris" au chapitre de ce manuel.

Es ist darauf zu achten, daß sich JPI in der Einstellung 2-3 An befindet. Schauen Sie unter "Jumpeereinstellungen für die Wake-On-Tastatur/Maus" in Kapitel 2 dieses Handbuches nach, um weitere Information zu erhalten.

3.11 Loading Fail-Safe Settings/Optimal Settings

Charger les Paramètres à Sécurité Relative Optimaux

Laden der Fail - Safe Einstellungen / Optimierte Einstellungen

The "Load Fail-Safe Settings" option loads the troubleshooting default values permanently stored in the ROM chips. These settings are not optimal and turn off all high performance features. You should use these values only if you have hardware problems. The "Load Optimal Settings" option loads optimized settings from the BIOS ROM. Use the Setup default values as standard values for your system.

L'option "Charger les Paramètres à Sécurité Relative" charge les valeurs de recherche de pannes par défaut stockées de manière permanente dans les puces ROM. Ces paramètres ne sont pas optimum et désactives toutes les fonctionnalités à haute performance. Vous pouvez utiliser ces valeurs seulement si vous rencontrez des problèmes de matériel.

Mit dieser Funktionen lassen sich Standardeinstellungen in dem permanenten ROM Speicher ablegen, die in Problemfällen geladen werden. Mit dieser Einstellung läßt sich der Computer im Standardmodus starten. Sie sollten diese Werte nur dann benutzen, wenn Hardwareprobleme etc. eine Starten des Computers nicht zulassen. Mit der Auswahl "Load Optimal Settings" lassen sich die optimierten Einstellungen von dem BIOS ROM abrufen. Die optimierten Einstellungen sind der Standardwert.

3.12 Setting the Supervisor/User Password

If you want to protect your system and the setup utility from unauthorized entry, set a password in the "Supervisor Password" field. If you want a user to have access only to your system but not to setup, set a password in the "User Password" field. Use the arrow keys to highlight the "Supervisor Password" or "User Password" field and press <Enter>. The message below will appear:

Enter Password:

Type in the password. You can enter up to eight characters only. You will then be prompted to confirm the password. Type in exactly the same password.

Make sure to set the "Security Option" field in the BIOS Features Setup to "System" or "Setup". This will depend on when you would like the system to be prompted with a password.

Définir le Mot de Passe Superviseur/Utilisateur

Si vous désirez protéger votre système et Install contre toute entrée non autorisée, paramétrez un mot de passe dans le champ "Supervisor Password". Si vous désirez protéger l'accès à Install seulement, mais pas votre système, paramétrez un mot de passe dans le champ "User Password". Utilisez les touches fléchées pour sélectionner le champ "Supervisor Password" ou "User Password" et appuyez sur <Entrée>. Le message ci-dessous apparaîtra.

Enter Password:

Entrez le mot de passe. Vous êtes limité à huit caractères. Une fois que c'est fait, vous serez invité à confirmer le mot de passe, entrez exactement le même mot de passe.

Assurez vous de positionner le champs "Security Option" dans les BIOS Features Setup sur "System" ou "Setup". Cela dépend du moment où vous désirez que le système vous demande le mot de passe.

Aktivieren eines Supervisor / Benutzer Paßwortes

Wenn Sie das "Supervisor Password" aktivieren, müssen Sie vor dem Einstieg in das Konfigurationsprogramm ein Kennwort eingeben, während das "User Password" den Zugang zu dem Computer ermöglicht. Wählen Sie den Eintrag "Supervisor Password" bzw. "Supervisor Password" und betätigen Sie die Eingabetaste (Enter). Im erscheinenden Dialogfeld.

Enter Password:

Geben Sie Ihr Kennwort mit bis zu 8 Stellen ein. Betätigen Sie die Eingabetaste und geben Sie das Kennwort als Bestätigung erneut ein.

Es ist darauf zu achten, daß das Feld "Security Option" in dem BIOS Features Setup auf "System" oder "Setup" gesetzt ist.

Chapter 4 - Supported Softwares

Logiciels Supportés

Unterstützte Software

4.1 Utility / Utilitaires / Hilfsprogramme

The CD included in the system board package contains a patch utility. If you are running Windows® 95 or Windows® 98, you need to run the patch utility.

Insert the CD into a CD-ROM drive. The autorun screen (Main Board Utility CD) will appear. Click "Patch Utility for Windows 95/98". Please refer to its "readme" file for instructions on installing the utility.

All steps or procedures to install the utility are subject to change without notice as the utility may occasionally be updated. Please refer to the readme file for the latest information.

Appendix A - System Error Message

Messages d'Erreur du Système

Fehlernachricht des Systems

When the BIOS encounters an error that requires the user to correct something, either a beep code will sound or a message will be displayed in a box in the middle of the screen and the message, PRESS F1 TO CONTINUE, CTRL-ALT-ESC or DEL TO ENTER SETUP, will be shown in the information box at the bottom. Enter Setup to correct the error.

A.1 POST Beep / Pip de POST / Akustisches POST-Signal

There are two kinds of beep codes in the BIOS. One code indicates that a video error has occurred and the BIOS cannot initialize the video screen to display any additional information. This beep code consists of a single long beep followed by three short beeps. The other code indicates that a DRAM error has occurred. This beep code consists of a single long beep.

A.2 Error Messages / Messages d'Erreur / Fehlernachrichten

One or more of the following messages may be displayed if the BIOS detects an error during the POST. This list indicates the error messages for all Awards BIOSes:

CMOS BATTERY HAS FAILED

The CMOS battery is no longer functional. It should be replaced.



Caution:

Danger of explosion if battery incorrectly replaced. Replace only with the same or equivalent type recommended by the manufacturer. Dispose of used batteries according to the battery manufacturer's instructions.

CMOS CHECKSUM ERROR

Checksum of CMOS is incorrect. This can indicate that CMOS has become corrupt. This error may have been caused by a weak battery. Check the battery and replace if necessary.

DISPLAY SWITCH IS SET INCORRECTLY

The display switch on the motherboard can be set to either monochrome or color. This indicates the switch is set to a different

setting than indicated in Setup. Determine which setting is correct, either turn off the system and change the jumper or enter Setup and change the VIDEO selection.

FLOPPY DISK(S) fail (80)

Unable to reset floppy subsystem.

FLOPPY DISK(S) fail (40)

Floppy type mismatch.

Hard Disk(s) fail (80)

HDD reset failed.

Hard Disk(s) fail (40)

HDD controller diagnostics failed.

Hard Disk(s) fail (20)

HDD initialization error.

Hard Disk(s) fail (10)

Unable to recalibrate fixed disk.

Hard Disk(s) fail (08)

Sector Verify failed.

Keyboard is locked out - Unlock the key

The BIOS detects that the keyboard is locked. Keyboard controller is pulled low.

Keyboard error or no keyboard present

Cannot initialize the keyboard. Make sure the keyboard is attached correctly and no keys are being pressed during the boot.

Manufacturing POST loop

System will repeat POST procedure infinitely while the keyboard controller is pull low. This is also used for the M/B burn in test at the factory.

BIOS ROM checksum error - System halted

The checksum of ROM address F0000H-FFFFFH is bad.

Memory test fail

The BIOS reports memory test fail if the memory has error(s).