

# **CI7BL**

**Half-Size 440BX Socket 370 CPU Card**

Version 1.0A

## **Industrial CPU Card**

PC-Based Computer Boards for Industrial Automation

## **User's Manual**

---

## Copyright Notice

This publication is protected by copyright and all rights are reserved. No part of it may be reproduced or transmitted by any means or in any form, without prior consent of the original manufacturer.

The information in this document has been carefully checked and is believed to be accurate. However, the original manufacturer assumes no responsibility for any inaccuracies that may appear in this manual. In no event will the original manufacturer be liable for direct, indirect, special, exemplary, incidental, incidental or consequential damages resulting from any defect or omission in this manual, even if advised of possibility of such damages. The material contained herein is for informational purposes only.

## Acknowledgments

Award is a registered trademark of Award Software International, Inc. IBM and PS/2 are trademarks of International Business Machines Corporation.

C&T is a trademark of Chips and Technologies Inc.

Intel and Pentium are registered trademarks of Intel Corporation.

Microsoft Windows is a registered trademark of Microsoft Corporation.

All other product names or trademarks are properties of their respective owners.

## CI7BL Series Comparison Table

Model	CI7BL	CI7BL(V)
Processor	Intel Celeron	Intel Celeron
Processor Socket	Socket 370	Socket 370
Chipset	Intel 440BX	Intel 440BX
BIOS	Award	Award
L2 cache	CPU Integrated	CPU Integrated
Max. SDRAM	256MB	256MB
Memory Sockets	1 x DIMM	1 x DIMM
VGA CRT/LCD	C&T 69000/69030	C&T 69000/69030
Watchdog Timer	16-level	16-level
Multi I/O Chip	Winbond 83977	Winbond 83977
Enhanced IDE	yes	yes
2S/1P	yes	yes
USB	yes	yes
IrDA	yes	yes
Ethernet (10/100Mbps)	Intel 82558B	no
H/W Monitoring	Winbond W83781D	Winbond W83781D
Board Size	185mm x 122mm	185mm x 122mm

# Contents

<b>Chapter 1 Introduction.....</b>	<b>1</b>
<b>Checklist.....</b>	<b>2</b>
<b>Description .....</b>	<b>2</b>
<b>Features .....</b>	<b>3</b>
<b>Specifications .....</b>	<b>3</b>
<b>Intelligence .....</b>	<b>5</b>
<b>Board Dimensions .....</b>	<b>6</b>
<b>Chapter 2 Installations .....</b>	<b>7</b>
<b>CPU Installation .....</b>	<b>8</b>
<b>Memory Installation.....</b>	<b>9</b>
<b>Jumpers on the CI7BL.....</b>	<b>10</b>
<b>Connectors on the CI7BL .....</b>	<b>14</b>
<b>Watchdog Timer Configuration .....</b>	<b>26</b>
<b>Chapter 3 BIOS Configuration.....</b>	<b>27</b>
<b>Chapter 4 Intel PIIX Bus Master IDE Driver Installation .....</b>	<b>53</b>
<b>Chapter 5 VGA Driver Installation.....</b>	<b>57</b>
<b>Chapter 6 LAN Driver Installation Guide.....</b>	<b>61</b>
<b>Chapter 7 System Monitor Utility .....</b>	<b>67</b>
<b>Chapter 8 LANdesk Client Manager.....</b>	<b>73</b>
<b>Appendix.....</b>	<b>81</b>
<b>A. I/O Port Address Map.....</b>	<b>82</b>
<b>B. Interrupt Request Lines (IRQ).....</b>	<b>83</b>

# 1

---

## Introduction

This manual is designed to give you information on the CI7BL CPU card. It is divided into the following sections:

- Checklist ..... 2
- Description ..... 2
- Features ..... 3
- Specifications ..... 3
- Intelligence ..... 5
- Board Dimensions ..... 6

The topics covered in this chapter are as follows:

- ◆ Checklist
- ◆ Description
- ◆ Features
- ◆ Specifications
- ◆ Layout of Key Components and Dimensions

## **Checklist**

---

---

Please check that your package is complete and contains the items below. If you discover damaged or missing items, please contact your dealer.

- The CI7BL Industrial CPU Card
- This User's Manual
- 1 IDE Ribbon Cable
- 1 Floppy Ribbon Connector
- 2 Serial Port Ribbon Cable and 1 Parallel Port attached to a Mounting Bracket
- 1 Diskette containing Intel PCI IDE Driver and Flash Memory Utility
- 2 Diskettes containing C&T 69000/69030 VGA Driver
- 2 Diskettes containing Intel 82558B LAN Driver
- 1 Diskette containing System Monitor utility
- 1 Optional CD containing *Intel LANDesk Client Manger*

## **Description**

---

---

The CI7BL is a Pentium II Industrial CPU card based on the Intel 440BX chipset and is fully designed for harsh industrial environment. It features a Socket-370 processor connector that is compatible with Intel Celeron processors. This card accommodates up to 256MB SDRAM configuration.

The CI7BL comes with Winbond's W83781D hardware monitoring device that monitors system and CPU temperature, system voltages, and CPU and chassis fan speeds to prevent system crashes by warning the user of adverse conditions. The power management feature provides power savings by slowing down the CPU clock, turning off the monitor screen and stopping the HDD spindle motor.

## Features

---

---

- CPU Speed 300~500MHz, Intel Celeron processors
- Bus Speed 66MHz/100MHz
- Intel 440BX AGPset
- Up to 256 SDRAM system memory, ECC function supported
- C&T 69000/69030 VGA chipset for LCD & CRT displays
- Two RS-232 serial ports
- 16 level programmable watchdog timer, from 0-30 seconds
- High speed bi-directional SPP/ECP/EPP parallel port
- Hardware Monitoring, Win95 shut-off, Modem ring-on
- 10/100M Base-T Ethernet interface, Novell NE2000 Compatible

## Specifications

---

---

- **Processor Socket:** Socket 370 connector
- **Processor:** Intel Coppermine Pentium III 500~800 MHz and Celeron 300~667MHz.  
  
\***Noted:** The processor specification of CI7BL Version 1.0 support Intel Celeron 300~500 MHz only but the version of CI7BL 1.00A also support both Intel Coppermine Pentium III 300~800 MHz and Celeron 300~667MHz.
- **Bus Speed:** 66MHz and 100MHz
- **Chipset:** Intel 440BX AGPset with PCI EIDE and RTC built-in
- **Secondary Cache:** CPU integrated
- **Memory Socket:**
  - One 168-pin DIMM socket
  - Max. 256MB SDRAM
  - Memory type: SDRAM (Synchronous DRAM)
- **BIOS:** Award BIOS, PnP support
  - FLASH EEPROM (256KB) for BIOS update
  - ISA Plug and Play (PnP) extension
  - Power management

- **DMI BIOS Support:**  
Desktop Management Interface (DMI) allows users to download system hardware-level information such as CPU type, CPU speed, internal/external frequencies and memory size.
- **Multi I/O:** Winbond W83977TF
- **Parallel Port:** One high-speed parallel port, SPP/EPP/ECP mode
- **Serial Port:** Two 16550 UART compatible ports configurable as RS232
- **Enhanced IDE:** Two Bus Mastering EIDE mode, up to 4 devices, Two EIDE interfaces for up to four devices, support PIO Mode 3/4 or Ultra DMA/33 IDE Hard Disk and ATAPI CD-ROM.
- **FDD Interface:** Two floppy drives (360KB, 720KB, 1.2MB, 1.44MB, 2.88MB, LS-120)
- **CRT/LCD:** C&T 69000/69030 chipset
  - Embedded 2MB SDRAM display memory
  - Simultaneous CRT & LCD display
  - LCD panel supports DSTN/TFT
  - 1280x1024x8bpp colors CRT resolution
  - Up to 1280x1024x8bpp colors resolution for color active matrix TFT panels (12, 18, and 24bit analog) or (12+12), (18+18) double pixel/CLK interface
- **USB Interface:** Two USB pin-header connectors, compliant with USB Specification Rev. 1.0
- **DiskOnChip:** The M-Systems flask disk supports system boot and storage capacity from 2MB to 72MB.
- **Watchdog Timer:** 16-level, programmable
  - I/O port 0443H to enable watchdog.
  - I/O port 0441H to disable watchdog.
  - Time-out timing select 0/2/4/6/8/10/12/14/16/18/20/22/24/26/28/30 seconds (+/-20%).
- **Green Function:** Power management via BIOS, activated through mouse/keyboard movement



- **PCI Bus Ethernet Interface:** Intel 82558B chipset
  - PCI local bus Ethernet controller
  - Supports IEEE802.3u auto-negotiation for automatic speed selection
  - support 10/100Mbps operation in a single port PCI bus master architecture
- **Keyboard and Mouse Connectors:** PS/2 type mini-DIN that supports PC/AT; supports a 5-pin external keyboard connector
- **IrDA Interface:** Pin-header connector for the optional IrDA external connector
- **Environmental and Mechanical:**
  - **Power Supply:** 10A @+5V(max), ±12V:100mA(max)
  - **Temperature:** 0°C to 60°C
  - **Humidity:** 5% to 95%
  - **Dimensions:** 185mm x 122mm (7.3" x 4.8")

---

## Intelligence

---

- **Temperature Monitoring and Alert:** A sensor for the CPU temperature on the CI7BL monitors the CPU temperature and alerts the user through the speaker or buzzer when temperature exceeds the safe heat level.
- **Windows 95/98 shut-off:** Allows shut-off control from within Windows 95/98 and through an ATX power supply.
- **Modem ring-on:** Allows system powering on through an external modem and through an ATX power supply.
- **Year 2000 Compliant BIOS:** The onboard Award BIOS is Year 2000 Compliant and will pass software applications that have the tendency to invoke INT1AH function 04H such as year2000.exe utility released by NSTL.
- **Wake On LAN:** Through an ATX power supply and network connection, systems can be turned on from the power-off state.

## Board Dimensions

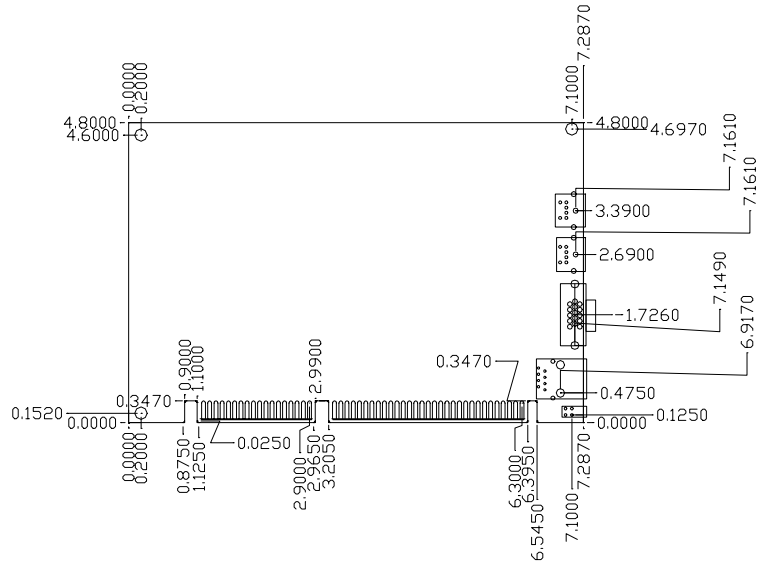

# 2

---

## Installations

This chapter provides information on how to use the jumpers and connectors on the CI7BL in order to set up a workable system. The topics covered are:

CPU Installation.....	8
Memory Installation .....	9
Jumpers on the CI7BL .....	10
Connectors on the CI7BL.....	14
Watchdog Timer Configuration .....	26

## **CPU Installation**

---

---

The CI7BL Industrial CPU Card supports a Socket 370 connector processor socket for Intel Celeron processors.

The Socket 370 connector uses a standard PGA socket connector. To install the CPU, insert it to the socket by aligning the notch of the Socket 370 CPU with the one of the PGA socket.

After you have installed the processor into place, check if the jumper setting for the CPU speed is correct.

**NOTE:** *Ensure that the CPU heat sink and the CPU top surface are in total contact to avoid CPU overheating problem that would cause your system to hang or be unstable.*

---

## Memory Installation

---

The CI7BL Industrial CPU Card supports one 168-pin DIMM socket for a maximum total memory of 256MB. The memory module can come in sizes of 16MB, 32MB, 64MB, 128MB and 256MB SDRAMs.

To install the DIMMs, locate the memory slots on the motherboard and perform the following steps:

1. Hold the DIMM so that the two keys of the DIMM align with those on the memory slot.
2. Gently push the DIMM in an upright position until the clips of the slot close to hold the DIMM in place when the DIMM touches the bottom of the slot.
3. To remove the DIMM, press the clips with both hands.

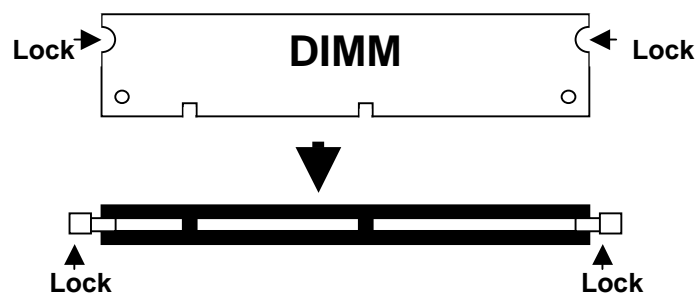

## Jumpers on the CI7BL

---

---

The jumpers on the CI7BL allow you to configure your CPU card according to the needs of your applications. If you have doubts about the best jumper configuration for your needs, contact your dealer or sales representative. The following table lists the connectors on CI7BL and their respective functions.

Jumper Locations on the CI7BL.....	11
DSW1 (1-8): CPU Frequency Selector .....	12
JP1: DiskOnChip BIOS Expansion Address Select .....	13
JP2: Clear CMOS Content .....	13
JP4: LCD Power Setting.....	13

*NOTE: Jumper J19 is for manufacturer testing use only.*

## Jumper Locations on the CI7BL

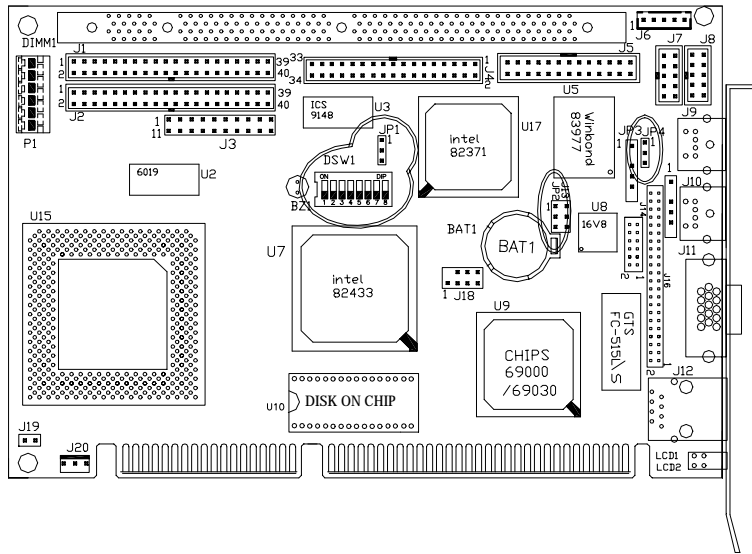

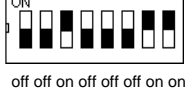
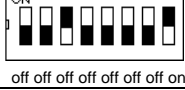
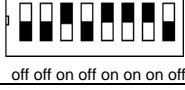
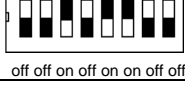
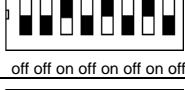
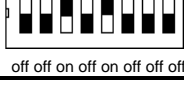

**DSW1 (1-8): CPU Frequency Selector**

The table below shows the correct setting to match the CPU frequency.



CPU Type	CPU Frequency	DSW1(1-8)
Celeron 66MHz Host Clock CPU	4.5x 66MHz 300MHz	 off off on off off on off on
	5x 66MHz 333MHz	 off off on off off off on on
	5.5x 66MHz 366MHz	 off off off off off off on on
	6x 66MHz 400MHz	 off off on on on on off off
	6.5x 66MHz 433MHz	 off off on off on on off off
	7x 66MHz 466MHz	 off off on on on off on off
	7.5x 66MHz 500MHz	 off off on on on off off off



**JP1: DiskOnChip BIOS Expansion Address Select**



JP1	Address
	D0000-D7FFF
	D8000-DFFFF (default)

**JP2: Clear CMOS Content**

JP2	Setting	Function
	Pin 2-3 Short/Closed	Clear CMOS Content
	Pin 1-2 Short/Closed	Normal Operation

**JP4: LCD Power Setting**

The CI7BL XGA interface supports 5V and 3.3V LCD displays. Use JP4 to change between 5V (*default*) and 3.3V panel video signal level.

JP4	Setting
	5V
	3.3V (default)

## Connectors on the CI7BL

---

---

The connectors on the CI7BL allows you to connect external devices such as keyboard, floppy disk drives, hard disk drives, printers, etc. The following table lists the connectors on CI7BL and their respective functions.

Connector Locations on the CI7BL.....	15
J1, J2: EIDE Connectors .....	16
J3: Front Bezel Connector.....	17
JP3: IrDA Connector .....	19
J4: Floppy Drive Connector .....	20
J5: Parallel Port Connector.....	20
J6: External Keyboard Connector .....	21
J7, J8: COM1/COM2 Serial Ports .....	21
J9: PS/2 Keyboard Connector .....	21
J10: PS/2 Mouse Connector .....	22
J11: VGA CRT Connector .....	22
J12: RJ45 Connector .....	22
J13: External ATX Power Connector.....	23
J14, J15: LCD Panel Connectors.....	23
J17, J18: USB Connectors.....	25
J20: CPU Fan Power Connector.....	25
J21: Chassis Fan Power Connector .....	25

## Connector Locations on the CI7BL

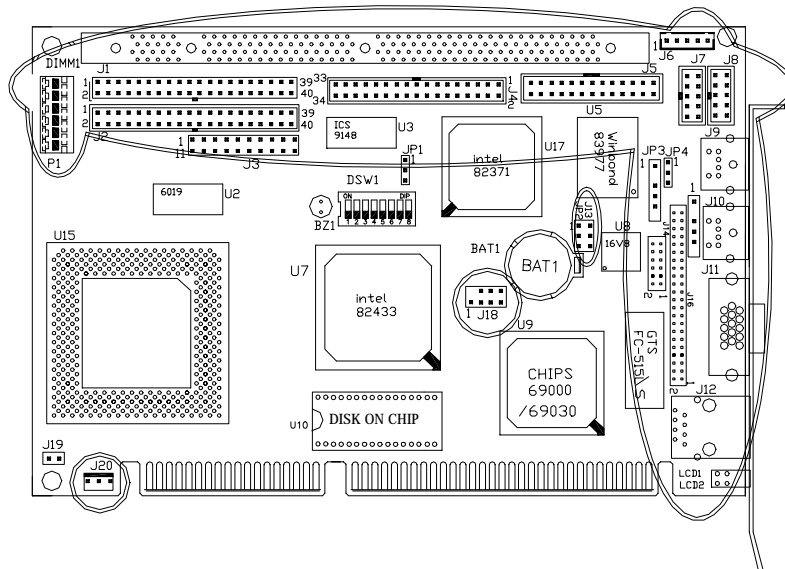

**NOTE:** Jumper J19 is for manufacturer testing use only.

**J1, J2: EIDE Connectors**

**J1: Primary IDE Connector**

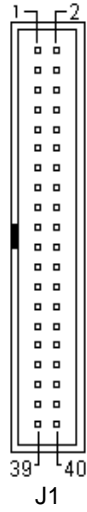

Signal Name	Pin #	Pin #	Signal Name
Reset IDE	1	2	Ground
Host data 7	3	4	Host data 8
Host data 6	5	6	Host data 9
Host data 5	7	8	Host data 10
Host data 4	9	10	Host data 11
Host data 3	11	12	Host data 12
Host data 2	13	14	Host data 13
Host data 1	15	16	Host data 14
Host data 0	17	18	Host data 15
Ground	19	20	Key
DRQ0	21	22	Ground
Host IOW	23	24	Ground
Host IOR	25	26	Ground
IOCHRDY	27	28	Host ALE
DACK0	29	30	Ground
IRQ14	31	32	No connect
Address 1	33	34	No connect
Address 0	35	36	Address 2
Chip select 0	37	38	Chip select 1
Activity	39	40	Ground

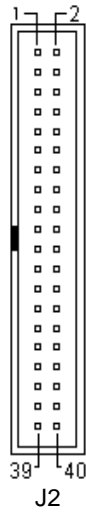
**J2: Secondary IDE Connector**

Signal Name	Pin #	Pin #	Signal Name
Reset IDE	1	2	Ground
Host data 7	3	4	Host data 8
Host data 6	5	6	Host data 9
Host data 5	7	8	Host data 10
Host data 4	9	10	Host data 11
Host data 3	11	12	Host data 12
Host data 2	13	14	Host data 13
Host data 1	15	16	Host data 14
Host data 0	17	18	Host data 15
Ground	19	20	Key
DRQ1	21	22	Ground
Host IOW	23	24	Ground
Host IOR	25	26	Ground
IOCHRDY	27	28	Host ALE
DACK1	29	30	Ground
IRQ15	31	32	No connect
Address 1	33	34	No connect
Address 0	35	36	Address 2
Chip select 0	37	38	Chip select 1
Activity	39	40	Ground

**J3: Front Bezel Connector**

The front bezel of the case has a control panel that provides light indication of the computer activities and switches to change the computer status. J1 is a 20-pin header that provides interfaces for the following functions.

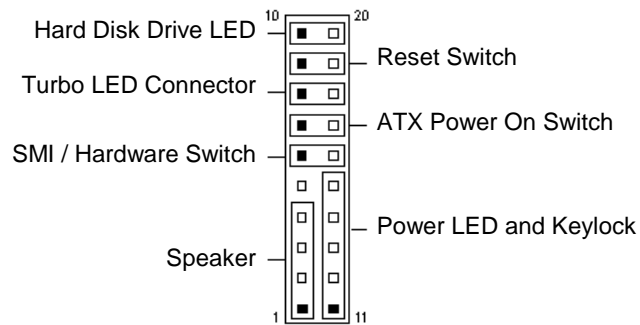

**Speaker: Pins 1 - 4**

This connector provides an interface to a speaker for audio tone generation. An 8-ohm speaker is recommended.

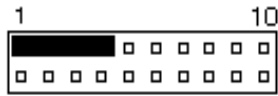

Pin #	Signal Name
1	Speaker out
2	No connect
3	Ground
4	+5V

**Power LED and Keylock: Pins 11 - 15**

The power LED indicates the status of the main power switch. The keylock switch, when closed, will disable the keyboard function.



Pin #	Signal Name
11	Power LED
12	No connect
13	Ground
14	Keylock
15	Ground

**SMI/Hardware Switch: Pins 6 and 16**

This connector supports the "Green Switch" on the control panel, which, when pressed, will force the system into the power-saving mode immediately.

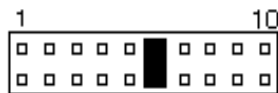

Pin #	Signal Name
6	Sleep
16	Ground

**ATX Power ON Switch: Pins 7 and 17**

This 2-pin connector is an "ATX Power Supply On/Off Switch" on the system that connects to the power switch on the case. When pressed, the power switch will force the system to power on. When pressed again, it will force the system to power off.

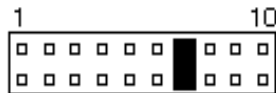

**Turbo LED Connector: Pins 8 and 18**

There is no turbo/deturbo function on the CPU card. The Turbo LED on the control panel will always be On when attached to this connector.

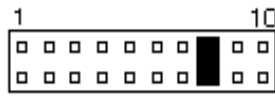

Pin #	Signal Name
8	5V
18	Ground

**Reset Switch: Pins 9 and 19**

The reset switch allows the user to reset the system without turning the main power switch off and then on again. Orientation is not required when making a connection to this header.

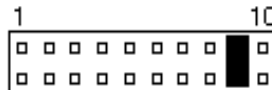

**Hard Disk Drive LED Connector: Pins 10 and 20**

This connector connects to the hard drive activity LED on control panel. This LED will flash when the HDD is being accessed.

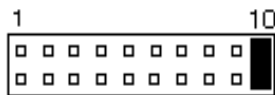

Pin #	Signal Name
10	Ground
20	5V

**JP3: IrDA Connector**

This connector is used for an IrDA connector for wireless communication.

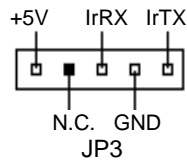

Pin #	Signal Name
1	+5V
2	No connect
3	IrRX
4	Ground
5	IrTX

### J4: Floppy Drive Connector

J4 is a 34-pin header and will support up to 2.88MB floppy drives.

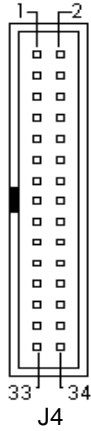

Signal Name	Pin #	Pin #	Signal Name
Ground	1	2	RM/LC
Ground	3	4	No connect
Ground	5	6	No connect
Ground	7	8	Index
Ground	9	10	Motor enable 0
Ground	11	12	Drive select 1
Ground	13	14	Drive select 0
Ground	15	16	Motor enable 1
Ground	17	18	Direction
Ground	19	20	Step
Ground	21	22	Write data
Ground	23	24	Write gate
Ground	25	26	Track 00
Ground	27	28	Write protect
Ground	29	30	Read data
Ground	31	32	Side 1 select
Ground	33	34	Diskette change

### J5: Parallel Port Connector

The following table describes the pin out assignments of this connector.

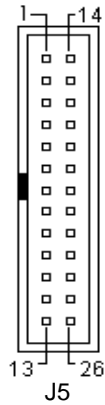

Signal Name	Pin #	Pin #	Signal Name
Line printer strobe	1	14	AutoFeed
PD0, parallel data 0	2	15	Error
PD1, parallel data 1	3	16	Initialize
PD2, parallel data 2	4	17	Select
PD3, parallel data 3	5	18	Ground
PD4, parallel data 4	6	19	Ground
PD5, parallel data 5	7	20	Ground
PD6, parallel data 6	8	21	Ground
PD7, parallel data 7	9	22	Ground
ACK, acknowledge	10	23	Ground
Busy	11	24	Ground
Paper empty	12	25	Ground
Select	13	N/A	N/A



### J6: External Keyboard Connector



Pin #	Signal Name
1	Keyboard clock
2	Keyboard data
3	NC
4	GND
5	Vcc

### J7, J8: COM1/COM2 Serial Ports

J7 and J8, 10-pin header connectors, are the onboard serial ports of CI7BL. The following table shows the pin assignments of this connector.

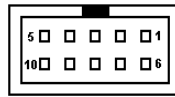

J7, J8

Pin #	Signal Name
1	DCD, Data carrier detect
2	RXD, Receive data
3	TXD, Transmit data
4	DTR, Data terminal ready
5	GND, ground
6	DSR, Data set ready
7	RTS, Request to send
8	CTS, Clear to send
9	RI, Ring indicator
10	NC

### J9: PS/2 Keyboard Connector

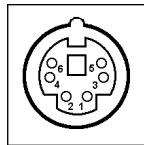

J9

Pin #	Signal Name
1	Keyboard data
2	N.C.
3	GND
4	5V
5	Keyboard clock
6	N.C.

### J10: PS/2 Mouse Connector

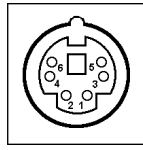

J10

Pin #	Signal Name
1	Mouse data
2	N.C.
3	N.C.
4	5V
5	Mouse Clock
6	N.C.

### J11: VGA CRT Connector

The pin assignments of the J11 VGA CRT connector are as follows:

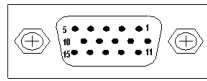

J11

Signal Name	Pin	Pin	Signal Name
Red	1	2	Green
Blue	3	4	N.C.
GND	5	6	GND
GND	7	8	GND
N.C.	9	10	GND
N.C.	11	12	N.C.
HSYNC	13	14	VSYNC
NC	15		

### J12: RJ45 Connector

This connector is for the 10/100Mbps Ethernet capability of the CPU card. The figure below shows the pin out assignments of this connector and its corresponding input jack.

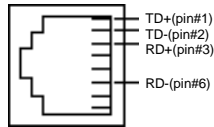

J12

### J13: External ATX Power Connector

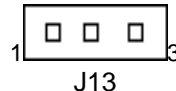

Pin #	Signal Name
1	GND
2	PS-ON (soft on/off)
3	5V SB (standby +5V)

### J14, J15: LCD Panel Connectors

J14 and J15 are pin headers for flat panel LCD displays. The following shows the pin assignments of this connector.

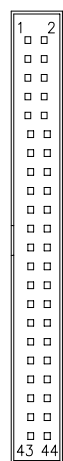

Signal Name	Pin #	Pin #	Signal Name
+12V	1	2	+12V
GND	3	4	GND
5V/3.3V	5	6	5V/3.3V
ENAVEE	7	8	GND
P0	9	10	P1
P2	11	12	P3
P4	13	14	P5
P6	15	16	P7
P8	17	18	P9
P10	19	20	P11
P12	21	22	P13
P14	23	24	P15
P16	25	26	P17
P18	27	28	P19
P20	29	30	P21
P22	31	32	P23
GND	33	34	GND
SHFCLK	35	36	FLM
MDE	37	38	LP
GND	39	40	ENABKL
GND	41	42	LCDVDD
DNAVDD	43	44	5V/3.3V

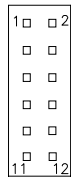

J14

Signal Name	Pin #	Pin #	Signal Name
P24	1	2	P25
P26	3	4	P27
P28	5	6	P29
P30	7	8	P31
P32	9	10	P33
P34	11	12	P35

### Flat Panel Display Interface Pin Descriptions

	Mono	Mono	Mono	Color	Color	Color	Color	Color	Color	Color	Color	Color	Color
	SS	DD	DD	TFT	TFT	TFT	TFT	TFT+HR	STN-SS	STN-SS	STN-DD	STN-DD	STN-DD
Pin Name	8-bit	8-bit	16-bit	9/12/16 bit	18/24 bit	36-bit	18/24 bit	8-bit (4bP)	16-bit (4bP)	8-bit (4bP)	16-bit (4bP)	24-bit	24-bit
P0	D0	UD3	UD7	B0	B0	FB0	FB0	R1	R1	UR1	UR0	UR0	
P1	D1	UD2	UD6	B1	B1	FB1	FB1	B1	G1	UG1	UG0	UG0	
P2	D2	UD1	UD5	B2	B2	FB2	FB2	G2	B1	UB1	UB0	UB0	
P3	D3	UD0	UD4	B3	B3	FB3	FB3	B3	R2	UR2	UR1	UR1	LR0
P4	D4	LD3	LD3	B4	B4	FB4	SB0	G4	G3	LR1	LR0	LR0	LG0
P5	D5	LD2	UD2	G0	B5	FB5	SB1	R5	B2	LG1	LG0	LB0	
P6	D6	LD1	UD1	G1	B6	SB0	SB2	B5	R3	LB1	LB0	UR1	
P7	D7	LD0	UD0	G2	B7	SB1	B3		G3	LR2	LR1	UG1	
P8			LD7	G3	G0	SB2	FG0		B3		UG1	UB1	
P9			LD6	G4	G1	SB3	FG1		R4		UB1	LR1	
P10			LD5	G5	G2	SB4	FG2		G4		UR2	LG1	
P11			LD4	R0	G3	SB5	FG3		B4		UG2	LB1	
P12			LD3	R1	G4	FG0	SG0		R5		LG1	UR2	
P13			LD2	R2	G5	FG1	SG1		G5		LB1	UG2	
P14			LD1	R3	G6	FG2	SG2		B5		LR2	UB2	
P15			LD0	R4	G7	FG3	SG3		G6		LG2	LR2	
P16					R0	FG4	FR0					LG2	
P17					R1	FG5	FR1					LB2	
P18					R2	SG0	FR2					UR3	
P19					R3	SG1	FR3					UG3	
P20					R4	SG2	SR0					LR3	
P21					R5	SG3	SR1					LG3	
P22					R6	SG4	SR2					LB3	
P23					R7	SG5	SR3						
P24						FR0							
P25						FR1							
P26						FR2							
P27						FR3							
P28						FR4							
P29						FR5							
P30						SR0							
P31						SR1							
P32						SR2							
P33						SR3							
P34						SR4							
P35						SR5							
SHFCLK	SHFCLK	SHFCLK	SHFCLK	SHFCLK	SHFCLK	SHFCLK	SHFCLK	SHFCLK	SHFCLK	SHFCLK	SHFCLK	SHFCLK	SHFCLK
Pixels/Cik:	8	8	16	1	1	2	2	2-2/3	5-1/3	2-2/3	5-1/3	8	

## J17, J18: USB Connectors

The following table shows the pin outs of the USB connectors.

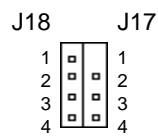

J18 Pin #	J17 Pin #	Signal Name
1	1	Vcc
2	2	USB-
3	3	USB+
4	4	Ground

*\*Noted: The Jumper of J20 was designed in the version of CI7BL 1.0 CPU card but it is moved from the CI7BL 1.00A CPU card.*

## J20: CPU Fan Power Connector

J20 is a 3-pin header for the CPU fan power. The fan must be a 12V fan.

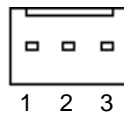

Pin #	Signal Name
1	Rotation
2	+12V
3	Ground

## J21: Chassis Fan Power Connector

J21 is a 3-pin header for the chassis fan power. The fan must be a 12V fan.

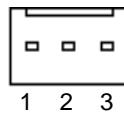

Pin #	Signal Name
1	Rotation
2	+12V
3	Ground

## Watchdog Timer Configuration

---

The function of the watchdog timer is to reset the system automatically and is defined at I/O port 0443H. To enable the watchdog timer and allow the system to reset, write I/O port 0443H. To disable the timer, write I/O port 0441H for the system to stop the watchdog function. The timer has a tolerance of 20% for its intervals.

The following describes how the timer should be programmed.

### Enabling Watchdog:

```
MOV AX, 000FH (Choose the values from 0)
MOV DX, 0443H
OUT DX, AX
```

### Disabling Watchdog

```
MOV AX, 00FH (Any value is fine.)
MOV DX, 0441H
OUT DX, AX
```

**WATCHDOG TIMER CONTROL TABLE**

Level	Value	Time/sec	Level	Value	Time/sec
1	F	0	9	7	16
2	E	2	10	6	18
3	D	4	11	5	20
4	C	6	12	4	22
5	B	8	13	3	24
6	A	10	14	2	26
7	9	12	15	1	28
8	8	14	16	0	30

# 3

## BIOS Configuration

This chapter describes the different settings available in the Award BIOS that comes with the CI7BL CPU card. The topics covered in this chapter are as follows:

BIOS Introduction.....	30
BIOS Setup .....	30
Standard CMOS Setup .....	32
Date .....	32
Time .....	33
Primary HDDs / Secondary HDDs .....	33
Drive A / Drive B .....	34
Video .....	34
Halt On .....	34
BIOS Features Setup.....	35
Virus Warning .....	35
CPU Internal Cache / External Cache.....	35
CPU L2 Cache ECC Checking .....	36
Quick Power On Self Test .....	36
Boot Sequence.....	36
Swap Floppy Drive.....	36
Boot Up Floppy Seek .....	36
Boot Up NumLock Status.....	36
Boot Up System Speed .....	36
Gate A20 Option .....	36
Typematic Rate Setting.....	36
Typematic Rate (Chars/Sec).....	37
Typematic Delay (Msec) .....	37
Security Option.....	37
PCI/VGA Palette Snoop .....	37

OS Select for DRAM > 64MB .....	37
Report No FDD for WIN 95 .....	37
Video BIOS Shadow.....	37
C8000 - CBFFF Shadow/DC000 - DFFFF Shadow	37
Chipset Features Setup .....	38
SDRAM RAS-to-CAS Delay.....	38
SDRAM RAS Precharge Time .....	38
SDRAM CAS Latency Time .....	38
Bank DRAM Timing .....	38
DRAM Clock.....	39
SDRAM Precharge Control .....	39
SDRAM Cycle Length.....	39
Memory Hole.....	39
Read Around Write.....	39
Concurrent PCI/Host.....	39
Video RAM Cacheable.....	39
DRAM Data Integrity Mode.....	39
System BIOS Cacheable .....	39
Video BIOS Cacheable.....	40
Video RAM Cacheable .....	40
8 Bit I/O Recovery Time .....	40
16 Bit I/O Recovery Time .....	40
Memory Hole at 15MB - 16MB .....	40
Passive Release.....	40
Delayed Transaction .....	40
CPU Warning Temperature .....	40
Current System/CPU Temperature .....	41
Current CPU Fan Speed/Chassis Fan Speed .....	41
VCCP / VTT / VCC3.....	41
Shutdown Temperature.....	41
Power Management Setup .....	42
ACPI function.....	42
Power Management .....	42
PM Control by APM.....	42
Video Off Method.....	43
Video Off After.....	43
Video Off Option.....	43
Modem Use IRQ.....	43
Doze Mode .....	43
Standby Mode.....	43
Suspend Mode .....	43
HDD Power Down.....	43
Throttle Duty Cycle .....	43



PCI/VGA Act-Monitor .....	44
Soft-Off by PWR-BTTN .....	44
Resume by Alarm .....	44
IRQ 8 Break Suspend .....	44
Reload Global Timer Events .....	44
PM Events .....	44
PNP/PCI Configuration.....	45
PNP OS Installed.....	45
Resources Controlled by.....	45
Reset Configuration Data .....	45
IRQ3/4/5/7/9/10/11/12/14/15, DMA0/1/3/5/6/7 assigned to .....	45
Load BIOS Defaults.....	46
Load Setup Defaults.....	46
Integrated Peripherals .....	47
IDE HDD Block Mode.....	47
IDE Primary/Secondary Master/Slave PIO .....	47
IDE Primary/Secondary Master/Slave UDMA .....	47
On-Chip Primary/Secondary PCI IDE.....	48
USB Keyboard Support.....	48
Init AGP Display First.....	48
Onboard FDC Controller .....	48
Onboard Serial/Parallel Port.....	48
UART Mode Select.....	48
Parallel Port Mode.....	48
Supervisor / User Password .....	49
IDE HDD Auto Detection.....	50
Save & Exit Setup .....	51
Exit Without Saving.....	51

## BIOS Introduction

---

The Award BIOS (Basic Input/Output System) installed in your computer system's ROM supports Intel Pentium II processors. The BIOS provides critical low-level support for standard devices such as disk drives, serial ports, and parallel ports. It also adds virus and password protection as well as special support for detailed fine-tuning of the chipset controlling the entire system.

## BIOS Setup

---

The Award BIOS provides a Setup utility program for specifying the system configurations and settings. The BIOS ROM of the system stores the Setup utility. When you turn on the computer, the Award BIOS is immediately activated. Pressing the <Del> key immediately allows you to enter the Setup utility. If you are a little bit late pressing the <Del> key, POST (Power On Self Test) will continue with its test routines, thus preventing you from invoking the Setup. If you still wish to enter Setup, restart the system by pressing the "Reset" button or simultaneously pressing the <Ctrl>, <Alt> and <Delete> keys. You can also restart by turning the system Off and back On again. The following message will appear on the screen:

```
Press <DEL> to Enter Setup
```

In general, you press the arrow keys to highlight items, <Enter> to select, the <PgUp> and <PgDn> keys to change entries, <F1> for help and <Esc> to quit.

When you enter the Setup utility, the Main Menu screen will appear on the screen. The Main Menu allows you to select from various setup functions and exit choices.

ROM PCI/ISA BIOS  
CMOS SETUP UTILITY  
AWARD SOFTWARE, INC.

<b>STANDARD CMOS SETUP</b>	INTEGRATED PERIPHERALS
BIOS FEATURES SETUP	SUPERVISOR PASSWORD
CHIPSET FEATURES SETUP	USER PASSWORD
POWER MANAGEMENT SETUP	IDE HDD AUTO DETECTION
PNP/PCI CONFIGURATION	SAVE & EXIT SETUP
LOAD BIOS DEFAULTS	EXIT WITHOUT SAVING
LOAD SETUP DEFAULTS	
ESC : Quit	↑ ↓ → ← : Select Item
F10 : Save & Exit Setup	(Shift) F2 : Change Color
Time, Date, Hard Disk Type	

The section below the setup items of the Main Menu displays the control keys for this menu. Another section at the bottom of the Main Menu just below the control keys section displays information on the currently highlighted item in the list.

**NOTE:** *After making and saving system changes with Setup, you find that your computer cannot boot, the Award BIOS supports an override to the CMOS settings that resets your system to its default.*

*We strongly recommend that you avoid making any changes to the chipset defaults. These defaults have been carefully chosen by both Award and your system manufacturer to provide the absolute maximum performance and reliability.*

## Standard CMOS Setup

“Standard CMOS Setup” choice allows you to record some basic hardware configurations in your computer system and set the system clock and error handling. If the card is already installed in a working system, you will not need to select this option. You will need to run the Standard CMOS option, however, if you change your system hardware configurations, the onboard battery fails, or the configuration stored in the CMOS memory was lost or damaged.

ROM PCI/ISA BIOS  
STANDARD CMOS SETUP  
AWARD SOFTWARE, INC.

Date (mm:dd:yy) : Wed, Mar 4 1998								
Time (hh:mm:ss) : 00 : 00 : 00								
HARD DISKS	TYPE	SIZE	CYLS	HEAD	PRECOMP	LANDZ	SECTOR	MODE
Primary Master	Auto	0	0	0	0	0	0	Auto
Primary Slave	Auto	0	0	0	0	0	0	Auto
Secondary Master	Auto	0	0	0	0	0	0	Auto
Secondary Slave	Auto	0	0	0	0	0	0	Auto
Drive A	: 1.44M, 3.5in							
Drive B	: None							
Video	: EGA / VGA							
Halt On	: All Errors							
			Base Memory			: 640K		
			Extended Memory			: 15360K		
			Other Memory			: 384K		
			Total Memory			: 16384K		
ESC : Quit			↑ ↓ → ← : Select			Item PU / PD / + / - : Modify		
F1 : Help			(Shift) F2 : Change Color					

At the bottom of the menu are the control keys for use on this menu. If you need any help in each item field, you can press the <F1> key. It will display the relevant information to help you. The memory display at the lower right-hand side of the menu is read-only. It will adjust automatically according to the memory changed. The following describes each item of this menu.

### Date

The date format is:

**Day :** Sun to Sat  
**Month :** 1 to 12  
**Date :** 1 to 31  
**Year :** 1994 to 2079

To set the date, highlight the “Date” field and use the PageUp/ PageDown or +/- keys to set the current time.

### Time

The time format is: **Hour : 00 to 23**  
**Minute : 00 to 59**  
**Second : 00 to 59**

To set the time, highlight the “Time” field and use the <PgUp>/<PgDn> or +/- keys to set the current time.

### Primary HDDs / Secondary HDDs

The onboard PCI IDE connectors provide Primary and Secondary channels for connecting up to four IDE hard disks or other IDE devices. Each channel can support up to two hard disks; the first is the “Master” and the second is the “Slave”.

To enter the specifications for a hard disk drive, you must select first a “Type”. There are 45 predefined types and 4 users definable types are for Enhanced IDE BIOS. Type 1 to 45 is predefined. Type “User” is user-definable. For the Primary Master/Slave as well as Secondary Master/Slave, you can select “Auto” under the TYPE and MODE fields. This will enable auto detection of your IDE drives and CD-ROM drive during POST.

Press <PgUp>/<PgDn> to select a numbered hard disk type or type the number and press the <Enter> key. The hard disk will not work properly if you enter incorrect information for this field. If your hard disk drive type is not matched or listed, you can use Type User to define your own drive type manually. If you select Type User, related information is asked to be entered to the following items.

**CYLS :** Number of cylinders  
**HEAD :** Number of read/write heads  
**PRECOMP :** Write precompensation  
**LANDZ :** Landing zone  
**SECTOR :** Number of sectors  
**SIZE :** Automatically adjust according to the configuration  
**MODE (for IDE HDD only) :** Auto  
Normal (HD < 528MB)  
Large (for MS-DOS only)  
LBA (HD > 528MB and supports  
Logical Block Addressing)

**NOTE:** *The specifications of your drive must match with the drive table. The hard disk will not work properly if you enter incorrect information in these fields. If your hard disk drive type is not matched or listed, you can use Type User to define your own drive type manually.*

**Drive A / Drive B**

These fields identify the types of floppy disk drive A or drive B that has been installed in the computer. The available specifications are:

360KB    1.2MB    720KB    1.44MB    2.88MB  
5.25 in.    5.25 in.    3.5 in.    3.5 in.    3.5 in.

**Video**

This field selects the type of video display card installed in your system. You can choose the following video display cards:

EGA/VGA	For EGA, VGA, SEGA, SVGA or PGA monitor adapters. (default)
CGA 40	Power up in 40 column mode.
CGA 80	Power up in 80 column mode.
MONO	For Hercules or MDA adapters.

**Halt On**

This field determines whether the system will halt if an error is detected during power up.

No errors	The system boot will not be halted for any error that may be detected.
All errors	Whenever the BIOS detects a non-fatal error, the system will stop and you will be prompted.
All, But Keyboard	The system boot will not be halted for a keyboard error; it will stop for all other errors
All, But Diskette	The system boot will not be halted for a disk error; it will stop for all other errors.
All, But Disk/Key	The system boot will not be halted for a keyboard or disk error; it will stop for all others.

## BIOS Features Setup

This section allows you to configure and improve your system and allows you to set up some system features according to your preference.

ROM / PCI ISA BIOS BIOS FEATURES SETUP AWARD SOFTWARE, INC.			
Virus Warning	: Disabled	Video BIOS Shadow	: Enabled
CPU Internal Cache	: Enabled	C8000-CBFFF Shadow	: Disabled
External Cache	: Enabled	CC000-CFFFF Shadow	: Disabled
CPU L2 Cache ECC Checking	: Enabled	D0000-D3FFF Shadow	: Disabled
Quick Power On Self Test	: Enabled	D4000-D7FFF Shadow	: Disabled
Boot Sequence	: A, C, SCSI	D8000-DBFFF Shadow	: Disabled
Swap Floppy Drive	: Disabled	DC000-DFFF Shadow	: Disabled
Boot Up Floppy Drive	: Enabled		
Boot Up Numlock Status	: On		
Gate A20 Option	: Fast		
Typematic Rate Setting	: Disabled		
Typematic Rate (chars/Sec)	: 6		
Typematic Delay (Msec)	: 250		
Security Option	: Setup		
PCI /VGA Palette Snoop	: Disabled		
OS Select For DRAM>64MB	: Non-OS2		
Report No FDD For WIN 95	: Yes		
		ESC : Quit	↑ ↓ → ← : Select Item
		F1 : Help	PU/PD/+/- : Modify
		F5 : Old Values	(Shift) F2 : Color
		F6 : Load BIOS Defaults	
		F7 : Load Setup Defaults	

### Virus Warning

This item protects the boot sector and partition table of your hard disk against accidental modifications. If an attempt is made, the BIOS will halt the system and display a warning message. If this occurs, you can either allow the operation to continue or run an anti-virus program to locate and remove the problem.

**NOTE:** *Many disk diagnostic programs, which attempt to access the boot sector table, can cause the virus warning. If you will run such a program, disable the Virus Warning feature.*

### CPU Internal Cache / External Cache

Cache memory is additional memory that is much faster than conventional DRAM (system memory). CPUs from 486-type on up contain internal cache memory, and most, but not all, modern PCs have additional (external) cache memory. When the CPU requests data, the system transfers the requested data from the main DRAM into cache memory, for even faster access by the CPU. These items allow you to enable (speed up memory access) or disable the cache function. By default, these items are **Enabled**.

**CPU L2 Cache ECC Checking**

When enabled, this allows ECC checking of the CPU's L2 cache. By default, this field is *Enabled*.

**Quick Power On Self Test**

When enabled, this field speeds up the Power On Self Test (POST) after the system is turned on. If it is set to *Enabled*, BIOS will skip some items.

**Boot Sequence**

This field determines the drive that the system searches first for an operating system. The default value is *A, C, SCSI*. The options are :

A, C, SCSI	D, A, SCSI	SCSI, C, A
C, A, SCSI	E, A, SCSI	C only
C, CDROM, A	F, A, SCSI	LS/ZIP, C
CDROM, C, A	SCSI, A, C	

**Swap Floppy Drive**

This item allows you to determine whether to enable Swap Floppy Drive or not. When enabled, the BIOS swaps floppy drive assignments so that Drive A becomes Drive B, and Drive B becomes Drive A. By default, this field is set to *Disabled*.

**Boot Up Floppy Seek**

When enabled, the BIOS will seek whether or not the floppy drive installed has 40 or 80 tracks. 360K type has 40 tracks while 760K, 1.2M and 1.44M all have 80 tracks. By default, this field is set to *Enabled*.

**Boot Up NumLock Status**

This allows you to activate the NumLock function after you power up the system. By default, the system boots up with *NumLock* On.

**Boot Up System Speed**

This has no function and selects the default system speed (*High*).

**Gate A20 Option**

This field allows you to select how Gate A20 is worked. Gate A20 is a device used to address memory above 1 MB. The default setting is *Fast*.

**Typematic Rate Setting**

When disabled, continually holding down a key on your keyboard will generate only one instance. When enabled, you can set the two typematic controls listed next. By default, this field is set to *Disabled*.



**Typematic Rate (Chars/Sec)**

When the typematic rate is enabled, the system registers repeated keystrokes speeds. You can select speed range from 6 to 30 characters per second. By default, this item is set to **6**.

**Typematic Delay (Msec)**

When the typematic rate is enabled, this item allows you to set the time interval for displaying the first and second characters. By default, this item is set to **250msec**.

**Security Option**

This field allows you to limit access to the System and Setup. The default value is **Setup**. When you select **System**, the system prompts for the User Password every time you boot up. When you select **Setup**, the system always boots up and prompts for the Supervisor Password only when the Setup utility is called up.

**PCI/VGA Palette Snoop**

Some non-standard VGA display cards may not show colors properly. This field allows you to set whether MPEG ISA/VESA VGA Cards can work with PCI/VGA or not. When this field is enabled, a PCI/VGA can work with a MPEG ISA/VESA VGA card. When this field is disabled, a PCI/VGA cannot work with a MPEG ISA/VESA Card.

**OS Select for DRAM > 64MB**

This option allows the system to access greater than 64MB of DRAM memory when used with OS/2 that depends on certain BIOS calls to access memory. The default setting is **Non-OS/2**.

**Report No FDD for WIN 95**

This option allows Windows 95 to share with other peripherals IRQ6 that is assigned to a floppy disk drive if the drive is not existing. The default setting is **No**.

**Video BIOS Shadow**

This item allows you to change the Video BIOS location from ROM to RAM. Video Shadow will increase the video speed.

**C8000 - CBFFF Shadow/DC000 - DFFFF Shadow**

Shadowing a ROM reduces the memory available between 640KB to 1024KB. These fields determine whether optional ROM will be copied to RAM or not.

## Chipset Features Setup

This Setup menu controls the configuration of the chipset.

ROM PCI/ISA BIOS CHIPSET FEATURES SETUP AWARD SOFTWARE INC.			
SDRAM RAS-to-CAS Delay	: 3	CPU Warning Temperature	: 66°C/151°F
SDRAM RAS Precharge Time	: 3	Current System Temp.	:
SDRAM CAS Latency Timer	: 3	Current CPU Temperature	:
SDRAM Precharge Control	: Disabled	CPU Fan Speed	:
DRAM Data Integrity Mode	: Non-ECC	Chassis Fan Speed	:
System BIOS Cacheable	: Disabled	VCCP (V):	1.98 V VTT (V) : 1.50 V
Video BIOS Cacheable	: Enabled	VCC3 (V) :	3.45 V + 5 V : 4.99 V
Video RAM Cacheable	: Enabled	+12 V :	12.46 V -12 V : -12.54V
8 Bit I/O Recovery Time	: 3	-5V :	- 5.21 V
16 Bit I/O Recovery Time	: 2	Shutdown Temperature	: 75°C/167°F
Memory Hole At 15MB-16MB	: Disabled		
Passive Release	: Enabled		
Delayed Transaction	: Disabled		
		ESC : Quit	↑ ↓ → ← : Select Item
		F1 : Help	PU/PD/+/- : Modify
		F5 : Old Values	(Shift) F2 : Color
		F6 : Load BIOS Defaults	
		F7 : Load Setup Defaults	

### SDRAM RAS-to-CAS Delay

When DRAM is refreshed, both rows and columns are addressed separately. This field allows you to determine the timing of transition from Row Address Strobe (RAS) to Column Address Strobe (CAS).

### SDRAM RAS Precharge Time

The precharge time is the number of cycles it takes for the RAS to accumulate its charge before DRAM refresh. If insufficient time is allowed, refresh may be incomplete and the DRAM may fail to retain data.

### SDRAM CAS Latency Time

When synchronous DRAM is installed, the number of clock cycles of CAS latency depends on the DRAM timing. Do not reset this field from the default value specified by the system designer.

### Bank DRAM Timing

These fields define the speed of the DRAM memory onboard. The options are *Normal*, *Medium*, *Fast*, *Turbo*, *SDRAM 8ns* and *SDRAM10ns*. By default, these fields are set to *SDRAM 10ns*.

### **DRAM Clock**

The DRAM Clock can be set to Host CLK or the CPU clock itself and to 66MHz. By default, this field is set to *Host CLK*.

### **SDRAM Precharge Control**

This field enables or disables the SDRAM Precharge Control.

### **SDRAM Cycle Length**

This field sets the SDRAM cycle length to either 2 or 3. The default setting is 3.

### **Memory Hole**

In order to improve performance, certain space in memory can be reserved for ISA cards. This field allows you to reserve 15MB to 16MB memory address space to ISA expansion cards. This makes memory from 15MB and up unavailable to the system. Expansion cards can only access memory up to 16MB. By default, this field is set to *Disabled*.

### **Read Around Write**

DRAM optimization feature: If a memory read is addressed to a location whose latest write is being held in a buffer before being written to memory, the read is satisfied through the buffer contents, and the read is not sent to the DRAM. The default setting is *Enabled*.

### **Concurrent PCI/Host**

This field enables or disables the concurrent PCI/Host. The default setting is *Disabled*.

### **Video RAM Cacheable**

Selecting *Enabled* allows caching of the video BIOS ROM at C0000h to C7FFFh, resulting in better video performance. However, if any program writes to this memory area, a memory access error may result.

### **DRAM Data Integrity Mode**

Set this field to *ECC* if the DRAM installed in the system supports it. Otherwise, do not reset the default of *Non-ECC*.

### **System BIOS Cacheable**

When enabled, access to the system BIOS ROM addressed at F0000H-FFFFFH is cached, provided that the cache controller is disabled.

#### **Video BIOS Cacheable**

When enabled, access to video BIOS addressed at C0000H to C7FFFH is cached, provided that the cache controller is disabled.

#### **Video RAM Cacheable**

Selecting *Enabled* allows caching of the video BIOS ROM at C0000h to C7FFFh, resulting in better video performance. However, if any program writes to this memory area, a memory access error may result.

#### **8 Bit I/O Recovery Time**

This option specifies the length of the delay (in sysclks) inserted between consecutive 8-bit I/O operations. The settings are 1, 2, 3, 4, 5, 6, 7, or 8. The default setting is 3.

#### **16 Bit I/O Recovery Time**

This option specifies the length of the delay (in sysclks) inserted between consecutive 16-bit I/O operations. The settings are 1, 2, 3, 4, 5, 6, 7, or 8. The default setting is 2.

#### **Memory Hole at 15MB - 16MB**

In order to improve performance, certain space in memory can be reserved for ISA cards. This field allows you to reserve 15MB to 16MB memory address space to ISA expansion cards. This makes memory from 15MB and up unavailable to the system. Expansion cards can only access memory up to 16MB. By default, this field is set to *Disabled*.

#### **Passive Release**

When enabled, CPU to PCI bus accesses are allowed during passive release. Otherwise, the arbiter only accepts another PCI master access to local DRAM.

#### **Delayed Transaction**

The chipset has an embedded 32-bit posted write buffer to support delay transactions cycles. Select *Enabled* to support compliance with PCI specification version 2.1. The default setting is *Enabled*.

#### **CPU Warning Temperature**

This field sets the threshold temperature at which an alert is sounded through the system's speaker. The CPU temperature is monitored by the onboard thermal sensor to prevent the CPU from overheating.

**Current System/CPU Temperature**

These read-only fields reflect the functions of the hardware thermal sensor that monitors the CPU and system temperatures to ensure the system is stable.

**Current CPU Fan Speed/Chassis Fan Speed**

These read-only fields show the current speeds in RPM (revolution per minute) for the CPU fan and chassis fan as monitored by the hardware monitoring IC.

**VCCP / VTT / VCC3**

These read-only fields show the current voltages in the voltage regulators and power supply as monitored by the hardware monitoring IC.

**Shutdown Temperature**

This field allows you to set the temperature at which the system automatically shuts down once it is reached, in order to avoid damage to system components.

## Power Management Setup

The Power Management Setup allows you to save energy of your system effectively. It will shut down the hard disk and turn off video display after a period of inactivity.

ROM PCI/ISA BIOS  
POWER MANAGEMENT SETUP  
AWARD SOFTWARE, INC.

ACPI Function	: Enabled	** Reload Global Timer Events **
Power Management	: User Define	IRQ3 (3-7, 9-15), NMI : Disabled
PM Control by APM	: Yes	Primary IDE 0 : Enabled
Video Off Method	: V/H SYNC +Blank	Primary IDE 1 : Enabled
Video Off After	: Standby	Secondary IDE 0 : Disabled
Modem Use IRQ	: 3	Secondary IDE 1 : Disabled
Doze Mode	: Disabled	Floppy Disk : Disabled
Standby Mode	: Disabled	Serial Port : Enabled
Suspend Mode	: Disabled	Parallel Port : Disabled
HDD Power Down	: Disabled	
Throttle Duty Cycle	: 62.5%	
PCI/VGA Active Monitor	: Disabled	
Soft-Off by PWR-BTTN	: Instant-Off	
PowerOn by Ring	: Disabled	
Resume by Alarm	: Disabled	
IRQ 8 Break Suspend	: Disabled	
		ESC : Quit                   ↑ ↓ → ← : Select Item
		F1 : Help                   PU/PD/+/- : Modify
		F5 : Old Values           (Shift) F2 : Color
		F6 : Load BIOS Defaults
		F7 : Load Setup Defaults

### ACPI function

ACPI stands for Advanced Configuration Power Interface. The default setting of this field is **Enabled**.

### Power Management

This field allows you to select the type of power saving management modes. There are four selections for Power Management.

- |                   |   |
|-------------------|---|
| Min. Power Saving | Minimum power management  |
| Max. Power Saving | Maximum power management.   |
| User Define       | Each of the ranges is from 1 min. to 1hr.<br>Except for HDD Power Down which ranges from 1 min. to 15 min.<br>(Default) |

**NOTE:** In order to enable the CPU overheat protection feature, the Power Management field should not be set to Disabled.

### PM Control by APM

This field allows you to use the Advanced Power Management device to enhance the Max. Power Saving mode and stop the CPU's internal clock. If the Max. Power Saving is not enabled, this will be preset to NO.

#### **Video Off Method**

This field defines the Video Off features. There are three options.  
V/H SYNC + Blank Default setting, blank the screen and turn off vertical and horizontal scanning.

DPMS Allows the BIOS to control the video display card if it supports the DPMS feature.

Blank Screen This option only writes blanks to the video buffer.

#### **Video Off After**

As the system moves from lesser to greater power-saving modes, select the mode in which you want the monitor to blank.

#### **Video Off Option**

This field determines the state at which video enters into when turned off. By default, this field is set to *Suspend -> Off*.

#### **Modem Use IRQ**

This field names the interrupt request (IRQ) line assigned to the modem (if any) on your system. Activity of the selected IRQ always awakens the system. By default, the IRQ is set to 3.

#### **Doze Mode**

When enabled, and after the set time of system inactivity, the CPU clock will run at a slower speed while all other devices still operate at full speed.

#### **Standby Mode**

After the selected period of system inactivity, the fixed disk drive and the video shut off while all other devices still operate at full speed.

#### **Suspend Mode**

When enabled, and after the set time of system inactivity, all devices except the CPU will be shut off.

#### **HDD Power Down**

When enabled, and after the set time of system inactivity, the hard disk drive will be powered down while all other devices remain active.

#### **Throttle Duty Cycle**

When the system enters Doze mode, the CPU clock runs only part of the time. You may select the percent of time that the clock runs.

#### **PCI/VGA Act-Monitor**

When enabled, any video activity restarts the global timer for Standby mode. The default setting is *Disabled*.

#### **Soft-Off by PWR-BTTN**

This field defines the power-off mode when using an ATX power supply. The Instant-Off mode allows powering off immediately upon pressing the power button. In the *Delay 4 Sec* mode, the system powers off when the power button is pressed for more than four seconds or places the system in a very low-power-usage state, with only enough circuitry receiving power to detect power button activity. The default value is *Instant-Off*.

#### **Resume by Alarm**

This allows a computer to be turned on automatically through the timer set in the BIOS to make the system more scheduleable. By default, this field is set to *Disabled*.

#### **IRQ 8 Break Suspend**

You can enable or disable the monitoring of IRQ 8 (Real Time Clock) so it does not awaken the system from Suspend mode.

#### **Reload Global Timer Events**

This section determines the reloading of the 'timers' after entering the Full On You can enable or disable the monitoring of IRQ 8 (Real Time Clock) so it does not awaken the system from Suspend mode.

#### **PM Events**

The VGA, LPT & COM, HDD & FDD, DMA /master, PWR-On by Modem/LAN, RTC Alarm Resume and Primary INTR section are I/O events which can prevent the system from entering a power saving mode or can awaken the system from such a mode. When an I/O device wants to gain the attention of the operating system, it signals this by causing an IRQ to occur. When the operating system is ready to respond to the request, it interrupts itself and performs the service. The default value is *Off*. When set On, activity will neither prevent the system from going into a power management mode nor awaken it. The IRQ section sets the wake-up call of the system. If activity is detected from any enabled IRQ channels in the left-hand group, the system wakes up from suspended mode.



## PNP/PCI Configuration

This option configures the PCI bus system. All PCI bus systems on the system use INT#, thus all installed PCI cards must be set to this value.

ROM PCI/ISA BIOS  
PNP/PCI CONFIGURATION  
AWARD SOFTWARE INC.

PNP OS Installed	: No	Used MEM base addr	: N/A
Resources Controlled by	: Manual		
Reset Configuration Data	: Disabled		
IRQ-3 assigned to	: Legacy ISA		
IRQ-4 assigned to	: Legacy ISA		
IRQ-5 assigned to	: PCI/ISA PnP		
IRQ-7 assigned to	: Legacy ISA		
IRQ-9 assigned to	: PCI/ISA PnP		
IRQ-10 assigned to	: PCI/ISA PnP		
IRQ-11 assigned to	: PCI/ISA PnP		
IRQ-12 assigned to	: PCI/ISA PnP		
IRQ-14 assigned to	: PCI/ISA PnP		
IRQ-15 assigned to	: PCI/ISA PnP		
DMA-0 assigned to	: PCI/ISA PnP		
DMA-1 assigned to	: PCI/ISA PnP	ESC : Quit	↑ ↓ ← : Select Item
DMA-3 assigned to	: PCI/ISA PnP	F1 : Help	PU/PD/+/- : Modify
DMA-5 assigned to	: PCI/ISA PnP	F5 : Old Values	(Shift) F2 : Color
DMA-6 assigned to	: PCI/ISA PnP	F6 : Load BIOS Defaults	
DMA-7 assigned to	: PCI/ISA PnP	F7 : Load Setup Defaults	

### PNP OS Installed

This field allows you to specify if the operating system installed in your system is plug and play aware.

**NOTE:** Operating systems such as DOS, OS/2, and Windows 3.x do not use PnP

### Resources Controlled by

This PnP BIOS can configure all of the boot and compatible devices automatically. However, this capability needs you to use a PnP operating system such as Windows 95. The default value is **Manual**.

### Reset Configuration Data

This field allows you to determine whether to reset the configuration data or not. The default value is **Disabled**.

### IRQ3/4/5/7/9/10/11/12/14/15, DMA0/1/3/5/6/7 assigned to

These fields allow you to determine the IRQ/DMA assigned to the ISA bus and is not available to any PCI slot.

### Used MEM base addr

Select a base address for the memory area used by any peripheral that requires high memory. The default setting is **N/A**.

### Load BIOS Defaults

This option allows you to load the troubleshooting default values permanently stored in the BIOS ROM. These default settings are non-optimal and disable all high-performance features.

ROM PCI/ISA BIOS  
CMOS SETUP UTILITY  
AWARD SOFTWARE, INC.

STANDARD CMOS SETUP	INTEGRATED PERIPHERALS
BIOS FEATURES SETUP	SUPERVISOR PASSWORD
CHIPSET FEATURES SETUP	USER PASSWORD
POWER MANAGE	DETECTION
PNP/PCI CONF	UP
<b>Load BIOS Defaults (Y/N)? N</b>	AVING
LOAD BIOS DEF	
LOAD SETUP DEF	
ESC : Quit	↑ ↓ → ← : Select Item
F10 : Save & Exit Setup	(Shift) F2 : Change Color
Load BIOS Defaults except Standard CMOS Setup	

To load BIOS defaults value to CMOS SRAM, enter “Y”. If not, enter “N”.

### Load Setup Defaults

This option allows you to load the default values to your system configuration. These default settings are optimal and enable all high performance features.

ROM PCI/ISA BIOS  
CMOS SETUP UTILITY  
AWARD SOFTWARE, INC.

STANDARD CMOS SETUP	INTEGRATED PERIPHERALS
BIOS FEATURES SETUP	SUPERVISOR PASSWORD
CHIPSET FEATURES SETUP	USER PASSWORD
POWER MANAGE	DETECTION
PNP/PCI CONF	UP
<b>Load Setup Defaults (Y/N)? N</b>	AVING
LOAD BIOS DEF	
<b>LOAD SETUP DEFAULTS</b>	
ESC : Quit	↑ ↓ → ← : Select Item
F10 : Save & Exit Setup	(Shift) F2 : Change Color
Load BIOS Defaults except Standard CMOS Setup	

To load SETUP defaults value to CMOS SRAM, enter “Y”. If not, enter “N”.

## Integrated Peripherals

This option sets your hard disk configuration, mode and port.

ROM PCI/ISA BIOS INTEGRATED PERIPHERALS AWARD SOFTWARE INC.			
IDE HDD Block Mode	: Enabled	Onboard Parallel Port	: 378/IRQ7
IDE Primary Master PIO	: Auto	Parallel Port Mode	: SPP
IDE Primary Slave PIO	: Auto		
IDE Secondary Master PIO	: Auto		
IDE Secondary Slave PIO	: Auto		
IDE Primary Master UDMA	: Auto		
IDE Primary Slave UDMA	: Auto		
IDE Secondary Master UDMA	: Auto		
IDE Secondary Slave UDMA	: Auto		
On-Chip Primary PCI IDE	: Enabled		
On-Chip Secondary PCI IDE	: Enabled		
USB Keyboard Support	: Disabled		
Init AGP Display First	: PCI slot		
Onboard FDC Controller	: Enabled		
Onboard Serial Port 1	: 3F8/IRQ4	ESC : Quit	↑ ↓ ← : Select Item
Onboard Serial Port 2	: 2F8/IRQ3	F1 : Help	PU/PD/+/- : Modify
UART Mode Select	: Normal	F5 : Old Values	(Shift) F2 : Color
		F6 : Load BIOS Defaults	
		F7 : Load Setup Defaults	

### IDE HDD Block Mode

This field allows your hard disk controller to use the fast block mode to transfer data to and from your hard disk drive.

### IDE Primary/Secondary Master/Slave PIO

These fields allow your system hard disk controller to work faster. Rather than have the BIOS issue a series of commands that transfer to or from the disk drive, PIO (Programmed Input/Output) allows the BIOS to communicate with the controller and CPU directly.

The system supports five modes, numbered from 0 (default) to 4, which primarily differ in timing. When Auto is selected, the BIOS will select the best available mode.

### IDE Primary/Secondary Master/Slave UDMA

These fields allow your system to improve disk I/O throughput to 33Mb/sec with the Ultra DMA/33 feature. The options are *Auto* and *Disabled*.

**On-Chip Primary/Secondary PCI IDE**

The integrated peripheral controller contains an IDE interface with support for two IDE channels. Select *Enabled* to activate each channel separately.

**USB Keyboard Support**

Select *Enabled* if your system contains a Universal Serial Bus (USB) controller and you have a USB keyboard.

**Init AGP Display First**

This field allows the system to initialize first the VGA card in the AGP slot when system is turned on.

**Onboard FDC Controller**

Select *Enabled* if your system has a floppy disk controller (FDC) installed on the system and you wish to use it. If you install an add-in FDC or the system has no floppy drive, select *Disabled* in this field. This option allows you to select the onboard FDD port.

**Onboard Serial/Parallel Port**

These fields allow you to select the onboard serial and parallel ports and their addresses. The default values for these ports are:

Serial Port 1	3F8/IRQ4
Serial Port 2	2F8/IRQ3
Parallel Port	378H/IRQ7

**UART Mode Select**

This field determines the UART mode in your computer. The settings are *Normal*, *IrDA* and *ASKIR*. The default value is *Normal*.

**Parallel Port Mode**

This field allows you to determine parallel port mode function.

SPP	Normal Printer Port
EPP	Enhanced Parallel Port
ECP	Extended Capabilities Port

## Supervisor / User Password

These two options set the system password. Supervisor Password sets a password that will be used to protect the system and Setup utility. User Password sets a password that will be used exclusively on the system. To specify a password, highlight the type you want and press <Enter>. The Enter Password: message prompts on the screen. Type the password, up to eight characters in length, and press <Enter>. The system confirms your password by asking you to type it again. After setting a password, the screen automatically returns to the main screen.

To disable a password, just press the <Enter> key when you are prompted to enter the password. A message will confirm the password to be disabled. Once the password is disabled, the system will boot and you can enter Setup freely.

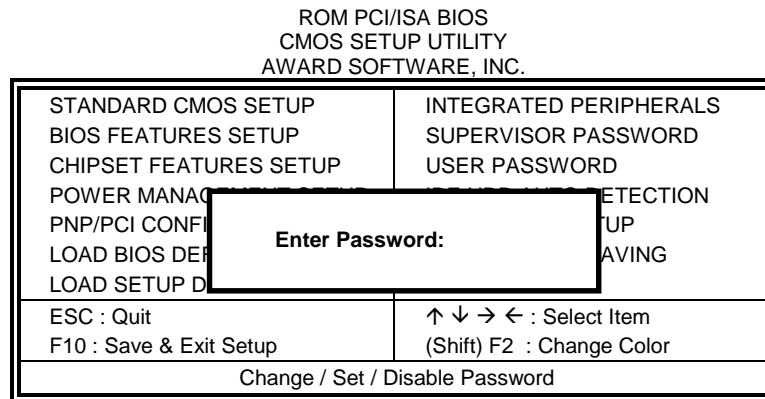

### IDE HDD Auto Detection

This option detects the parameters of an IDE hard disk drive, and automatically enters them into the Standard CMOS Setup screen.

ROM PCI/ISA BIOS  
STANDARD CMOS SETUP  
AWARD SOFTWARE, INC.

HARD DISKS	TYPE	SIZE	CYLS	HEAD	PRECOMP	LANDZ	SECTOR	MODE
Primary Master:								
Select Primary Master Option (N=SKIP) : N								
OPTIONS	TYPE	SIZE	CYLS	HEAD	PRECOMP	LANDZ	SECTOR	MODE
1 (Y)	0	0	0	0	0	0	0	NORMAL
NOTE: Some OSes (like SCO-UNIX) must use "NORMAL" for installation								
<b>ESC: SKIP</b>								

Up to four IDE drives can be detected, with parameters for each appearing in sequence inside a box. To accept the displayed entries, press the "Y" key to skip to the next drive, press the "N" key. If you accept the values, the parameters will appear listed beside the drive letter on the screen.

### Save & Exit Setup

This option allows you to determine whether to accept the modifications or not. If you type “Y”, you will quit the setup utility and save all changes into the CMOS memory. If you type “N”, you will return to Setup utility.

ROM PCI/ISA BIOS  
CMOS SETUP UTILITY  
AWARD SOFTWARE, INC.

STANDARD CMOS SETUP	INTEGRATED PERIPHERALS
BIOS FEATURES SETUP	SUPERVISOR PASSWORD
CHIPSET FEATURES SETUP	USER PASSWORD
POWER MANAGE	DETECTION
PNP/PCI CONF	UP
LOAD BIOS DEF	AVING
LOAD SETUP DEFAULTS	
ESC : Quit	↑ ↓ → ← : Select Item
F10 : Save & Exit Setup	(Shift) F2 : Change Color
Save Data to CMOS & Exit Setup	

### Exit Without Saving

Select this option to exit the Setup utility without saving the changes you have made in this session. Typing “Y” will quit the Setup utility without saving the modifications. Typing “N” will return you to Setup utility.

ROM PCI/ISA BIOS  
CMOS SETUP UTILITY  
AWARD SOFTWARE, INC.

STANDARD CMOS SETUP	INTEGRATED PERIPHERALS
BIOS FEATURES SETUP	SUPERVISOR PASSWORD
CHIPSET FEATURES SETUP	USER PASSWORD
POWER MANAGE	DETECTION
PNP/PCI CONF	UP
LOAD BIOS DEF	AVING
LOAD SETUP DEFAULTS	
ESC : Quit	↑ ↓ → ← : Select Item
F10 : Save & Exit Setup	(Shift) F2 : Change Color
Abandon all Data & Exit Setup	

This page was intentionally left blank.



# 4

---

## Intel PIIX Bus Master IDE Driver Installation

This chapter describes the installation procedure for Intel PIIX Bus Master IDE Drivers for Windows 95.

This chapter contains the following sections:

System Requirements .....	54
Installing the Software .....	55

## **System Requirements**

---

---

This section describes system requirements for the PIIX Bus Master IDE Device Driver for Windows 95\*. This driver has been designed for and tested with Windows 95 only. This driver will only install on systems with Windows 95.

1. The system must contain a supported Intel processor and chipset configuration.
2. Ensure that a mouse is connected to the system.
3. One of the following versions of Windows 95\* must be installed on the system prior to running utility program.

Windows 95\* 4.00.950 (Retail)

Windows 95\* 4.00.950a (OSR1)

Windows 95\* 4.00.950b (OSR2 without USB Supplement)

Windows 95\* 4.00.950b (OSR2.1 with USB Supplement)

4. This utility should only be used on desktop systems. The utility must not be executed on notebook or portable systems with or without dock.
5. It is assumed that the BIOS properly initialized the 82371xB IDE interface for Bus Master IDE operation.
6. There is no other non-82371xB IDE controllers (add-in IDE controller or sound card with IDE) enabled on the system.

## Installing the Software

---

---

This subsection describes how to install the software on a system where Windows 95 is installed.

**NOTE:** Record the location of the Windows 95\* directory before installing the driver.

1. Check the System Requirements. Windows 95\* must be fully installed and running on the system prior to running this software.
2. Close any running applications.
3. Remove references to installed real-mode IDE device drivers in the AUTOEXEC.BAT and CONFIG.SYS files (especially any drivers that control ATAPI CD-ROM and special IDE features). Use the Notepad utility to do this.

The driver files are stored in an integrated application setup program.

This program is a Windows 95\* program that allows the driver files to be **INSTALLED** or **DE-INSTALLED**.

Execute the driver setup program.

Run **SETUP.EXE**.

4. Click 'Next' on Welcome Screen to read and agree to the license agreement. View the text file and choose File\Exit to close Notepad and continue. **NOTE:** If you click **No**, program will terminate.
5. Click **Yes** if you agree to continue. **NOTE:** If you click 'No', the program will terminate.
6. Select **INSTALL**, to install the PIIX Bus Master IDE Device Driver when prompted to do so.

**NOTE:** If the driver is currently installed on the system, **SETUP** will ask you whether or not you want to continue. Follow the prompts on the screen to install the driver if desired.

7. Click 'OK' to restart the system when prompted to do so.
8. Follow the screen instructions and use default settings to complete the setup when Windows 95\* is re-started. Upon re-start, Windows 95\* will display that it has found an Intel PCI Bus Master IDE controller hardware and is installing hardware for it.

If a **New Hardware Found** dialog box is displayed requesting the location of the drivers, use the mouse to click on the scrollbar and click on the <Windows 95\* directory>\System\IOSubSys path:

For example:

Click on **C:\WINDOWS\SYSTEM\IOSUBSYS\**

Click **OK**.

9. Select **Yes**, when prompted to re-start Windows 95.

**NOTE:** After installation, the following driver and related files are stored as listed.

<Windows 95\* directory>\System\IOSubSys\IDEATAPI.MPD

<Windows 95\* directory>\System\IOSubSys\PIIXVSD.VXD

<Windows 95\* directory>\INF\IDEATAPI.INF

# 5

---

## VGA Driver Installation

This chapter provides information on how to install the C&T 69000/69030 VGA drivers that come in the two floppy diskettes with the package. Please follow the instructions set forth in this chapter carefully. Please note that there must be relevant software installed in your system before you could proceed to install the VGA drivers. It is recommended that you make a copy of the VGA driver diskette and put the backup copy in a safe place.

The following items are covered in this chapter:

Installing the Drivers for Windows 95.....	58
Installing the Drivers for Windows 98.....	59
Installing the Drivers for Windows NT 4.0 .....	60

## **Installing the Drivers for Windows 95**

---

---

The following section describes the normal display driver installation procedures for Windows 95. Use the following procedures when installing the display drivers for Windows 95.

1. Click **Start**. Select **Settings**, then click the **Control Panel** icon.
2. Double click **Display**.
3. Click **Settings**.
4. Click **Advanced Properties**.
5. Click **Change**.
6. Click **Have Disk ....**
7. Insert the diskette/CD containing the **69000/69030 VGA driver for Windows 95** to the floppy disk drive/CD-ROM drive, then type in **A:\WIN95** (assuming drive A is your floppy disk drive) or type in **D:\VGA\C&T\WIN95** (assuming drive D is your CD-ROM drive), and press **Enter**.
8. Select **Chips and Tech. 69000/69030 PCI/AGP**, and then click **OK**. After the files are copied, click **Close**.
9. Click **Yes** to restart your computer and for the new settings to take effect.

## Installing the Drivers for Windows 98

---

---

The following section describes the normal display driver installation procedures for Windows 98. Use the following procedures when installing the display drivers for Windows 98.

1. Click **Start**. Select **Settings**, and then click the **Control Panel** icon.
2. Double click **Display**.
3. Click **Settings**.
4. Click **Advanced....**
5. Click **Adapter**.
6. Click **Change....**
7. Click **Next**.
8. Select **Display a list of all the drivers in a specific location, so you can select the driver you want**.
9. Click "**Have Disk ...**".
10. Insert the diskette/CD containing the **C&T 69000/69030 VGA driver for Windows 98** to the floppy disk drive/CD-ROM drive, then type in **A:\WIN98** (assuming drive A is your floppy disk drive) or type in **D:\VGA\C&T\WIN98** (assuming drive D is your CD-ROM drive), and press **Enter**.
11. Select **Chips and Tech. 69000/69030 PCI/AGP**", and click **OK**.
12. Click **Next**. After the files are copied, and click **Finish**.
13. Click **Close**.
14. Click **Close**.
15. Click **Yes** to restart your computer and for the new settings to take effect.

## **Installing the Drivers for Windows NT 4.0**

---

**IMPORTANT:** You should install the Windows NT 4.0 Service Pack 3 first before installing the C&T 69000/69030 VGA drivers. If you don't have the Windows NT 4.0 Service Pack 3, please contact your software vendor or download it from Microsoft's web site.

The procedures below show you how to install the C&T 69000/69030 VGA drivers for Windows NT 4.0.

1. Boot Windows NT 4.0.
2. Double click the **My Computer** icon.
3. Double click the **Control Panel** icon.
4. Double click the **Display" icon.**
5. Click **Change Display Type.**
6. Click **Change.**
7. Click **Have Disk**, then insert the diskette/CD containing the **C&T 69000/69030 VGA driver for Windows NT 4.0** to the floppy disk drive/CD-ROM drive, then type in **A:\WINNT40** (assuming drive A is your floppy disk drive) or type in **D:\VGA\C&T\WINNT40** (assuming drive D is your CD-ROM drive), and press **Enter.**
8. Select **Chips Video Accelerator (65545/48/50/54/55 68554 69000/69030)**, and then click **OK.**
9. Click **Yes** to copy the drivers from the floppy disk/CD to the hard disk.
10. When copying is done, click **OK.**
11. Click **Close.**
12. Click **OK.**
13. Windows NT 4.0 will prompt you to restart computer. Click **OK** to change the Windows NT configuration.



# 6

---

## LAN Driver Installation Guide

This chapter describes LAN features and driver installation of the onboard Intel 82558B Ethernet controller.

The following items are covered in this chapter:

Introduction .....	62
Features .....	62
Software Drivers Support .....	62
Running Diagnostics.....	63

## Introduction

---

Intel 82558B is a 32-bit 10/100Mbps Ethernet controller for PCI local bus-compliant PCs. It supports the bus mastering architecture, and Auto-negotiation feature which make it possible to combine one common type of Ethernet cabling – an RJ-45 connector for twisted-pair cabling that can be used for both 10Mbps and 100Mbps connection. Extensive driver support for commonly used network operating systems is also provided.

## Features

---

- Conforms to the Ethernet IEEE 802.3u standard
- Compatible with PCI Local Bus Revision 2.1 specification
- IEEE 802.3u Auto-Negotiation for automatic speed selection
- Supports Full-Duplex/Half-Duplex Operation
- Provides 32-bit bus mastering data transfer
- Supports 10Mbps and 100Mbps operation in a single port

\* *Requires ATX power supply with 5VSB, 720mA*

## Software Drivers Support

---

### NetWare ODI Drivers

Novell NetWare 3.x, 4.x, NetWare LAN WorkPlace TCP/IP, Novell LAN Analyzer for NetWare

### NDIS Drivers

Microsoft LAN Manager V2.x, Windows 3.x, Windows NT 4.0, Windows NT 3.51, Windows 98, Windows 95, SCO3, SCO5; IBM LAN Server 4.0 for DOS and OS/2, and Linux.

## Running Diagnostics

The CI7BL comes with two diskettes containing drivers and diagnostic software supporting the Intel 82558B Ethernet controller. Follow the steps below to use the *Setup Utility*.

1. Run the file SETUP.EXE typing a:\setup in the DOS prompt, assuming your floppy disk drive is drive A. Upon doing so, the system starts the *Setup Utility* and shows the following screen.

```

8255x-based PCI EtherExpress™ adapter Setup V4.16

```

```

Main Menu
-----
Automatic setup
View adapter configuration
Test adapter
Install network drivers
View Help files
Exit Setup

```

Choose AUTOMATIC SETUP to view the adapter's configuration, make sure it works properly, and install the software needed to connect to your network.

Help = F1 Exit = Esc Select = ↑↓ Action = ↵

2. Selecting **View adapter configuration** will show the following.

```

8255x-based PCI EtherExpress™ adapter Setup V4.16

```

```

View adapter configuration
-----
Adapter type:.....
Adapter part number:.....
Network address:.....
Interrupt:.....
Bus:.....
Slot:.....
Device:.....
Network speed:.....
Physical layer device:.....
Duplex:.....
Adapter capabilities:
  100BaseTX, full or half duplex.
  10BaseT, full or half duplex.

Press Enter to continue

```

Help = F1 Previous = Esc Continue = Enter PCI Advanced = F5

3. Selecting **Test adapter** will show the following screen.

8255x-based PCI EtherExpress™ adapter Setup V4.16

Test adapter

Bus=0 Dev=0Bh Slot=11 Addr=004063001000 IRQ=10  
Diagnostic tests:

Adapter tests .....	Passed
Onboard loopback tests .....	passed
Network test .....	passed

10Mbps

This adapter works properly

Press Enter to continue

Help = F1                      Press Enter to continue

---

4. Selecting **Install network drivers** will show the following screen.

8255x-based PCI EtherExpress™ adapter Setup V4.16

Main Menu

Install network drivers

Novel

Microsoft

Other

Exit Setup

Choose OTHER if you use a network operating system from a manufacturer not on this list (such as Banyan or UNIX).

Help = F1                      Press Enter to continue

---

5. Upon selecting **Others** under the **Install network drivers main menu** screen, the following screen will appear.

---

8255x-based PCI EtherExpress™ adapter Setup V4.16

---

Other

1. LANtastic 6.0
2. Banyan 6.00 NDIS workstation
3. NDIS 2.x driver notes (OS/2\*, LAN Manager\* others)
4. Using IBM LAN support for AS/400 and NetWare
5. LAN Server
6. UNIX driver information

Choose OTHER if you use a network operating system from a manufacturer not on this list (such as Banyan or UNIX).

Help = F1 Previous = Esc Select = ↑↓ Accept = ↵

---

6. Selecting **View Help files** under the **Main menu** will show the following screen.

---

8255x-based PCI EtherExpress™ adapter Setup V4.16

---

Main Menu

View Help files

Installing EtherExpress™ PRO/100+ adapter drivers  
Latest News and general adapter information  
Hardware specifications and cabling information  
Adapter installation and special configurations  
Running diagnostics and error messages

Help = F1 Previous = Esc Select = ↑↓ Display Choices = ↵

---

This page was intentionally left blank.

# 7

---

## System Monitor Utility

This chapter introduces System Monitor Utility that comes with the package in conjunction with the onboard hardware monitoring IC. The sections below give the functions of the utility.

System Monitor is a software utility that oversees the general performance of systems, covering areas like system temperature, system voltage, CPU and system fan rotational speeds. If conditions become adverse, that is, when voltages are erratic or CPU temperature exceeds the safe limits, an alarm will be sounded; thereby preventing system crashing and ensuring overall stability.

When System Monitor is initiated, the icon below appears in the task bar in the Windows environment.



The following screen appears upon clicking on the System Monitor icon.



Clicking on the 'X' on the upper right corner would show you the latest company information or on any icon on the left side to display further information.

The following section describes the different functions of System Monitor.



1. Computer - displays the operating working system version and processor type.



2. Memory - displays the current memory usage status.

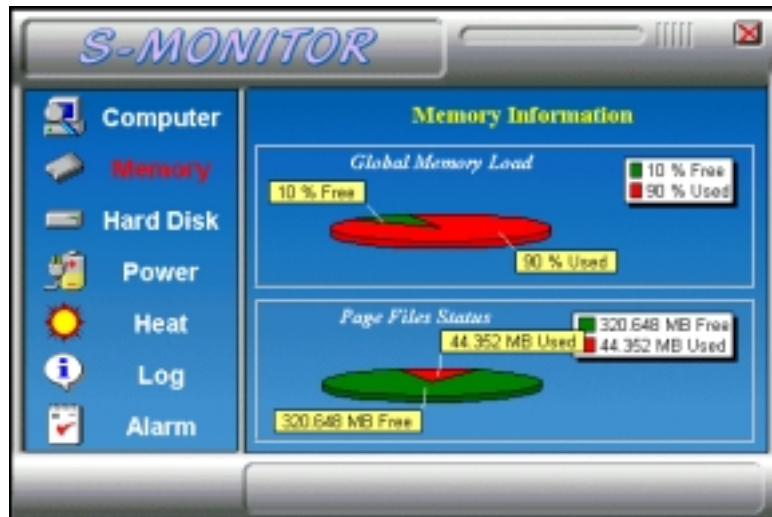

5. Hard Disk - displays the supported disk formats and disk space.



4. Heat - displays the current rotational speed of CPU and Chassis fans, as well as the system and CPU temperatures.

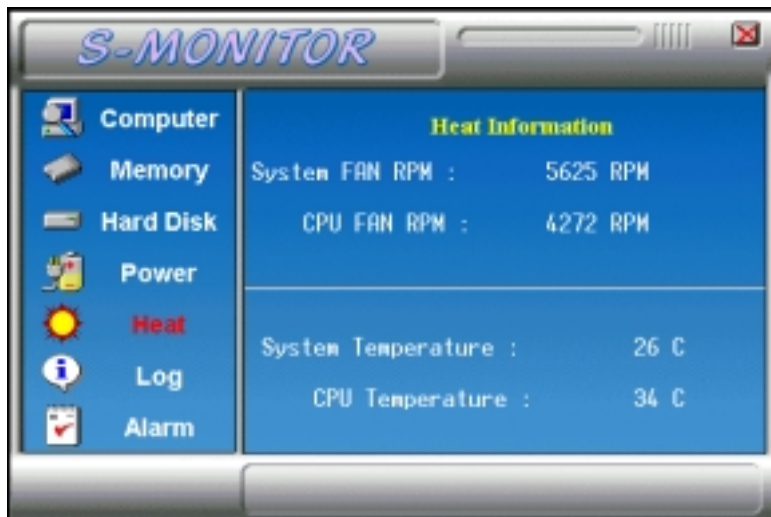

5. Power - displays the current voltage status.

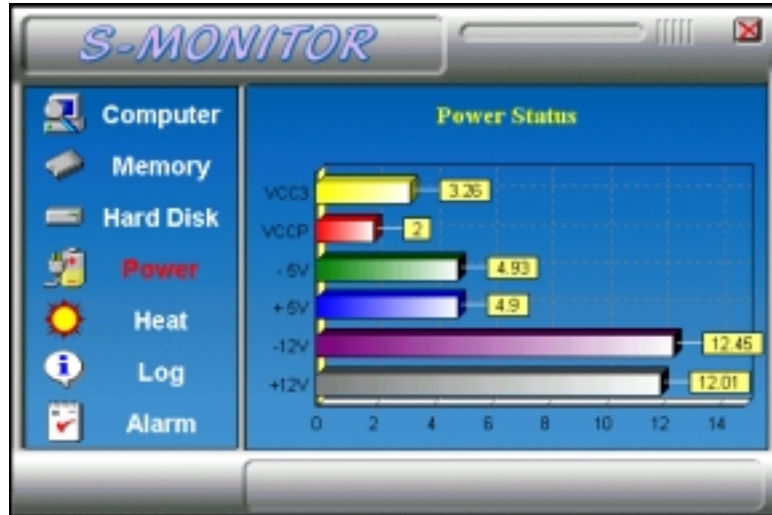

**NOTE:** For Pentium II processors, System Monitor detects the VCC3 and VCCP values. For Pentium-level processors, System Monitor detects the VCORE and VIO values.

6. Log - displays errors occurring after System Monitor is started.



7. Alarm - sets the values at which an alarm is sounded.



Voltage : the acceptable voltage range between the "Hi Limit" and "Lo Limit" value.

Temperature : temperature threshold.

Fan Rotation Speed : the minimum rotation speed.

*NOTE: Intel has defined a margin of difference for the voltages as below:*

*12 Volts - 10% (10.8V ~ 13.2V)*

*5 Volts - 5% (4.75 ~ 5.25%)*

*Vio - 5% (Vio for P54C CPU is 3.5V. Vio for P55C is 3.3V.)*

*Vcore- 5%*

*\* VCC3 / VIO and VCCP / VCORE values vary according to the processors used. Please contact the CPU manufacturer for further information.*

# 8

---

## LANDesk Client Manager

This chapter gives a brief introduction to the optional LANDesk® Client Manager (LDCM) utility, as well as the installation procedures.

The following items are covered in this chapter:

Introduction .....	74
Installation .....	75
Installing the Local Version of LDCM.....	76
Installing the Administrative Version of LDCM .....	78

## Introduction

---

LANDesk Client Manager (LDCM 3.1) provides the capability for managing components (network interface cards, memory, printers, software applications, etc.) within a PC system. It uses the Desktop Management Interface (DMI) standard established by the Desktop Management Task Force (DMTF). Manageable components can be viewed, monitored, and administrated across multiple platforms, either locally or remotely on a network.

The LDCM package has been implemented in two different ways: a user (client/local) version and an administrative version (Remote Companion). The user version provides the ability to only manage the local PC. The administrative version allows a network administrator to manage the local PC and other PC nodes on the network. This means that the administrative version has the ability to gather information about remote PCs, as well as remotely controlling the PCs. The remote access based upon granted rights by the managed client.

LDCM provides the user with self-help diagnostics, including a PC health meter, local alerting of potential problems, and hardware and software inventory. Automatic polling and alerting of memory and hardware conditions and predictive failure mechanisms minimize downtime and increase effective troubleshooting. LDCM can take periodic “snapshots” of critical configuration files for easy change management and restoration when needed.

To use LDCM, your computer must meet the following requirements:

- Operating System: Windows 95, Windows NT 3.51, or Windows NT4.0
- Memory: about 200KB
- Disk Storage Space: 3-5MB
- Hardware System: a DMI BIOS is required for full LDCM functionality

For network computers, the following requirements also apply:

- Protocols: IPX or IP (WinSock-enabled) communication protocol loaded on the client
- Hardware Interfaces: a network card for communication on the network

## Installation

The optional LANDesk utility that comes with the CPU card runs in Windows NT or Windows 95 operating system.

Upon entering the Windows NT 4.0 or Windows 95 environment, insert the CD. Windows will autorun the installation program and show the following screen.

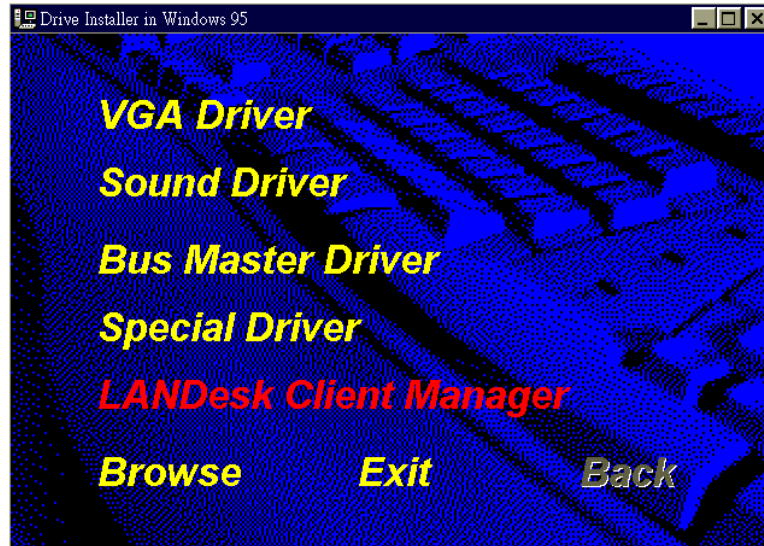

**NOTE:** During Setup, you will be asked to install Internet Explorer 3.02 in order to continue, or else Setup will be aborted. LDCM supports various languages and will default to English if it is unable to load 'language.dl'..

### Installing the Local Version of LDCM

Double Click on 'LANdesk Client Manager' in the initial screen and the following screen will appear. Double click on the local version of LANdesk Client Manager.



When the Welcome screen appears, click on "Next" to continue with Setup.

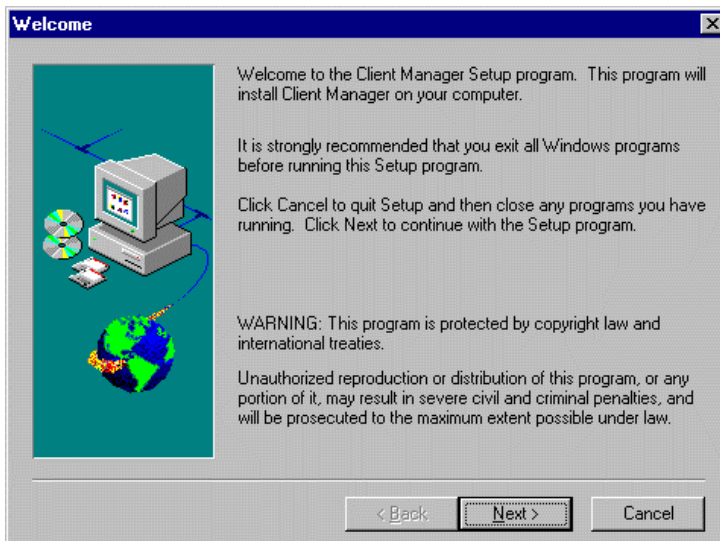



Choose the directory location where Setup will install LANdesk Client Manager. Click "Browse" if you want to change the directory suggested. Otherwise, click "Next" to start installing LDCM.

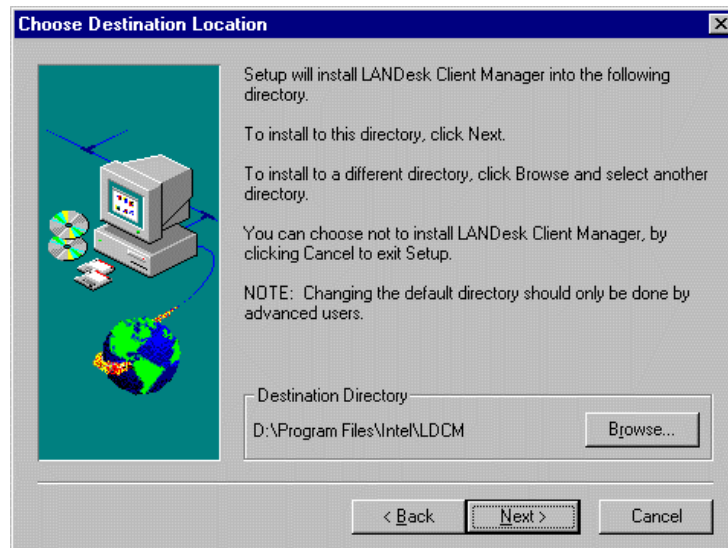

When Setup is finished, changes will have been made to the file AUTOEXEC.BAT. Restart your computer for the changes to take effect.

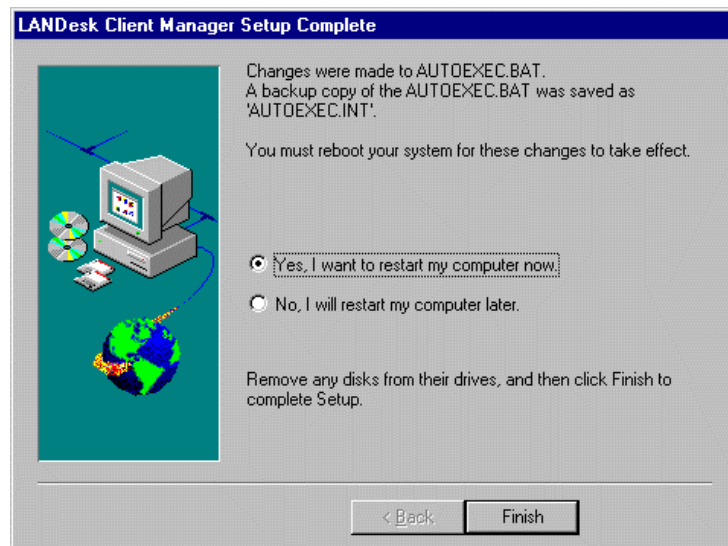

### Installing the Administrative Version of LDCM

After double clicking on 'LANdesk Client Manager' in the initial screen, select the administrative version of the LDCM and the Welcome screen below will appear. Click on "Next" to continue.

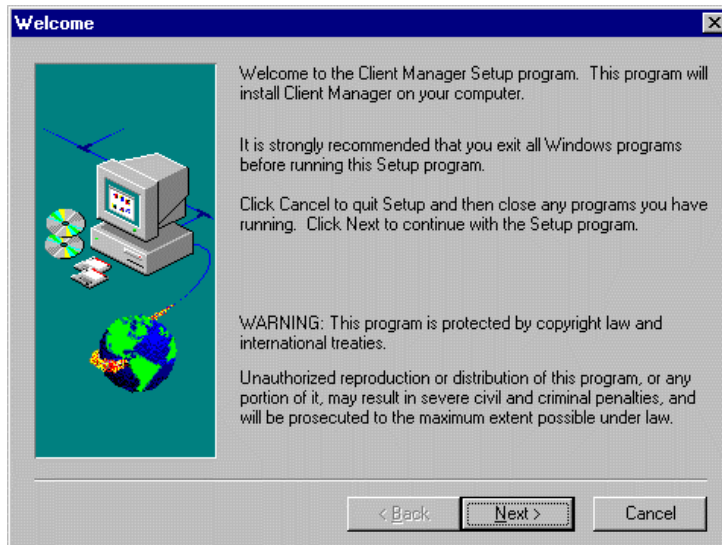

The screen below allows you to install the documentation in Adobe Acrobat format and the Adobe Acrobat Reader software. Select the options you need and click on "Next" to start the installation.

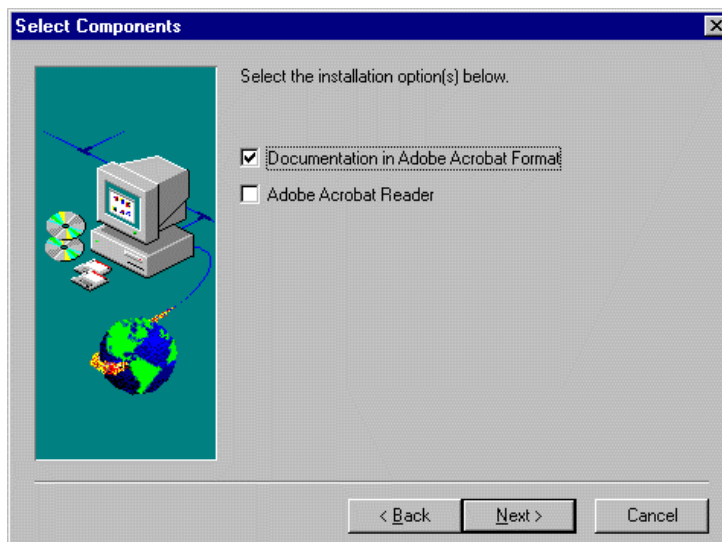

After LANDesk Client Manager Setup is complete, restart your computer to be able to use the LANDesk Client Manager.

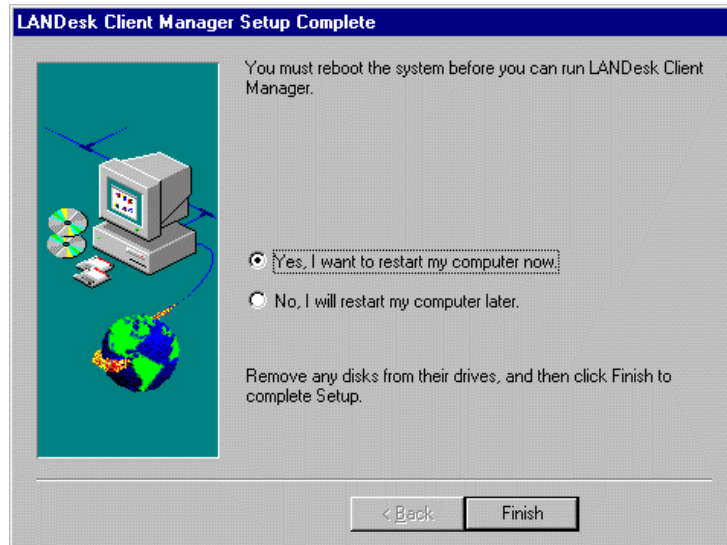

This page was intentionally left blank.

# Appendix

**A. I/O Port Address Map**

**B. Interrupt Request Lines (IRQ)**

## A. I/O Port Address Map

Each peripheral device in the system is assigned a set of I/O port addresses, which also becomes the identity of the device. There is a total of 1K port address space available. The following table lists the I/O port addresses used on the Industrial CPU Card.

Address	Device Description
000h - 01Fh	DMA Controller #1
020h - 03Fh	Interrupt Controller #1
040h - 05Fh	Timer
060h - 06Fh	Keyboard Controller
070h - 07Fh	Real Time Clock, NMI
080h - 09Fh	DMA Page Register
0A0h - 0BFh	Interrupt Controller #2
0C0h - 0DFh	DMA Controller #2
0F0h	Clear Math Coprocessor Busy Signal
0F1h	Reset Math Coprocessor
1F0h - 1F7h	IDE Interface
278 - 27F	Parallel Port #2(LPT2)
2F8h - 2FFh	Serial Port #2(COM2)
2B0 - 2DF	Graphics adapter Controller
378h - 3FFh	Parallel Port #1(LPT1)
360 - 36F	Network Ports
3B0 - 3BF	Monochrome & Printer adapter
3C0 - 3CF	EGA adapter
3D0 - 3DF	CGA adapter
3F0h - 3F7h	Floppy Disk Controller
3F8h - 3FFh	Serial Port #1(COM1)

---

## B. Interrupt Request Lines (IRQ)

---

There are a total of 15 IRQ lines available on the Industrial CPU Card. Peripheral devices use interrupt request lines to notify CPU for the service required. The following table shows the IRQ used by the devices on the Industrial CPU Card.

Level	Function
IRQ0	System Timer Output
IRQ1	Keyboard
IRQ2	Interrupt Cascade
IRQ3	Serial Port #2
IRQ4	Serial Port #1
IRQ5	Parallel Port #2
IRQ6	Floppy Disk Controller
IRQ7	Parallel Port #1
IRQ8	Real Time Clock
IRQ9	Software Redirected to Int 0Ah
IRQ10	Reserved
IRQ11	Reserved
IRQ12	Reserved
IRQ13	80287
IRQ14	Primary IDE
IRQ15	Secondary IDE