

TI7NBA
Socket 370 ATX Motherboard
User's Manual
Version 1.0B

The brand names, product names and trade names in this manual are trademarks or registered trademarks of their respective holders.

This publication is protected by copyright and all rights are reserved. No part of it may be reproduced or transmitted by any means or in any form, without prior consent in writing from the manufacturer.

The information in this document has been carefully checked and is believed to be accurate. However, the manufacturer assumes no responsibility for any inaccuracies that may appear in this manual. In no event will the manufacturer be liable for direct, indirect, special, exemplary, incidental or consequential damages resulting from any defect or omission in this manual, even if advised of the possibility of such damages. The material contained herein is for informational purposes only.

README FIRST

If your motherboard has a VIA 82C693 (Apollo Pro Plus) chipset, please do the following.

1. For Windows 95.

- a. Install Windows 95 OSR2 or later version.
- b. Install USB supplement to OSR2. You may download the supplement from Microsoft's web site.
- c. Install VIA VXD Driver (VIA_GART table driver) V2.6 or later version. The driver can be found in the enclosed CD. Refer to the following figure.
- d. Install the VGA driver as supplied by the VGA vendor.
- e. Install the VIA IDE driver version V2.1.26 or later version from the enclosed CD.

2. For Windows 98

- a. Install the VIA Chipset Functions' Registry Driver V1.1 or later version. It is imperative that this driver is installed first, even if you don't have an AGP card in your system.
- b. Install the VIA VXD Driver (VIA_GART table driver) V2.6 or later version. The driver can be found in the enclosed CD.
- c. Install the VGA driver as supplied by the VGA vendor.
- d. Install the VIA IDE driver version V2.1.26 or later version. The driver can be found in the enclosed CD.

Contents

Chapter 1 Introduction.....	1
Chapter 2 Specifications.....	2
Chapter 3 Hardware Description	5
3.1 Processor.....	7
3.2 L2 Cache.....	7
3.3 Main Memory	7
3.4 BIOS	9
3.5 I/O Port Address Map.....	9
3.6 DMA Channels	10
3.7 Interrupt Request (IRQ) Lines	10
3.8 Onboard PCI-IDE.....	10
3.9 Onboard Multi-I/O.....	11
3.10 Onboard AGP Slot.....	11
3.11 Hardware Monitoring IC	11
3.12 Onboard Audio	11
Chapter 4 Configuring the Motherboard	13
4.1 CPU Frequency/Speed Setting.....	15
4.2 Clear CMOS Select: JP10.....	15
4.3 Bus Speed Select: JP8.....	16
Chapter 5 Installation	17
5.1 I/O Connectors.....	19
5.2 JP1: PS/2 Keyboard and PS/2 Mouse Connectors	19
5.3 J1, J2: Serial Ports	20
5.4 J4: Parallel Port Connector	20
5.5 P1: Line Out/Line In/ Microphone, Game Port	21
5.6 JP3: IrDA Connector	21
5.7 JP5, JP6: CD-ROM Audio In Connectors	21
5.8 JP7: Wake on LAN Connector	22
5.9 J7: CPU Fan Power Connector	22
5.10 J13: Chassis Fan Power Connector.....	22
5.11 J19: AGP Fan Power Connector.....	22
5.12 J14: ATX Power Supply Connector	23
5.13 J16: Floppy Drive Connector.....	23
5.14 J17, J15: EIDE Connectors.....	23
5.15 J18: Front Bezel Connectors.....	25

Chapter 6 BIOS and System Setup.....	29
6.1 BIOS Introduction	32
6.2 BIOS Setup.....	32
6.3 Standard CMOS Setup	34
6.4 BIOS Features Setup	37
6.5 Chipset Features Setup	41
6.6 Power Management Setup	46
6.7 PNP/PCI Configuration	50
6.8 Load BIOS Defaults	53
6.9 Load Setup Defaults	53
6.10 CPU Speed Setting	54
6.11 Integrated Peripherals.....	56
6.12 Supervisor / User Password.....	59
6.13 IDE HDD Auto Detection	60
6.14 Save & Exit Setup	61
6.15 Exit Without Saving	61
Chapter 7 Audio Driver Installation Guide.....	62
Chapter 8 System Monitor Utility User's Guide	72
Chapter 9 LANdesk User's Guide	80
9.1 Introduction	81
9.2 Installation.....	82
9.2.1 Installing the Local Version of LDCM.....	83
9.2.2 Installing the Administrative Version of LDCM	85

Chapter 1 Introduction

This manual is designed to give you information on the TI7NBA motherboard. It is divided into the following sections:

- **Introduction**
- **Specifications**
- **Hardware Description**
- **Configuring the Motherboard**
- **Installation**
- **BIOS and System Setup**
- **Audio Driver Installation Guide**
- **System Monitor Utility User's Guide**
- **LANDesk User's Guide**

Checklist

Please check that your package is complete and contains the items below. If you discover damaged or missing items, please contact your dealer.

- The TI7NBA Motherboard
- 1 IDE ribbon cable
- 1 floppy ribbon cable
- 1 CD containing *System Monitor*, PIIX4 Bus Master IDE driver and utilities. *The Intel LANDesk Client Manager software is optional.*

Chapter 2 Specifications

The TI7NBA is a high-performance ATX motherboard with a Socket 370 connector for PPGA 370-type Pentium® II processors. It offers flexibility in terms of CPU frequency and main memory type and size. The main features of the motherboard consist of the following:

CPU Socket

Socket 370

Processor

Intel Celeron
300~600MHz CPU frequency

Bus Speed

66~150MHz

L2 Cache

CPU integrated L2 cache

CPU Voltage

Switching voltage regulator on board supporting multiple voltage ranging 1.3V-2.0V

Main Memory

Three 168-pin DIMM sockets

NOTE: For 440ZX chipset-based motherboard, there are only two DIMM memory sockets.

Memory types: SDRAM (Synchronous DRAM)

NOTE: Use only SDRAM modules that support SPD (Serial Presence Detect). Install PC100 modules when running 100MHz CPU bus speed and PC66 modules when running 66MHz CPU bus speed.

Chipset

Intel 82440BX /ZX/GX or VIA 82C693 with built-in PCI-IDE

Onboard Audio

The onboard audio consists of the Creative ES1373 Chip + AC97. With a PCI Bus Mastering interface with DOS compatibility, it supports 32 voices wavetable, surround sound, 3D audio, and audio effects such as reverb and chorus. Creative ES1373 uses single, shareable PCI interrupt and is PC97/PC98 compliant.

BIOS

Y2K compliant Award BIOS featuring ISA PnP extension, DMI, bootable CD-ROM and power-management features

Power Connector

ATX power supply connector (*Use an ATX power supply with 3.3V power.*)

DMI BIOS Support

Desktop Management Interface (DMI) allows users to download system hardware-level information such as CPU type, CPU speed, internal/external frequencies and memory size.

PCI Bus Master IDE Controller (Ultra DMA/33)

Onboard PCI Bus Master IDE (Ultra DMA/33) controller with two connectors for up to four IDE devices in two channels, supporting enhanced IDE devices such as Tape Backup and CD-ROM drives, PIO Mode 3/4 and Bus Mastering Ultra DMA/33 (*You have to install the Bus Master IDE driver to enable this feature.*)

Super I/O

Onboard super I/O is a Winbond W83977TF that provides:

- Two 16550 UART compatible serial ports
- One parallel port (ECP/EPP compatible)
- One floppy controller (2.88MB compatible)
- One IrDA port
- Keyboard Controller

Keyboard and Mouse Connectors

PS/2 type

USB Connector

2 ports onboard

Win95-shut-off

Allows shut-off control from within Windows 95

Modem-ring-on

Supports PC powering on through an external modem.

Onboard AGP Slot

The AGP (Accelerated Graphics Port) slot supports AGP compliant VGA cards to achieve rich 3D and video graphics display. AGP is a bus specification that enables 3D graphics capabilities including support for z-buffering, alpha blending and faster texture mapping.

Expansion Slots

Four PCI 32-bit slots

Two ISA 16-bit slots

One AGP slot

NOTE: *For 440ZX chipset-based motherboard, there are three PCI Master 32-bit slots and one PCI slave 32-bit slot. The PCI slave slot is PCI4.*

Form Factor

ATX, 12.05" x 7.09" (30.6cm x 18cm)

Chapter 3 Hardware Description

This chapter briefly describes each of the major features of the TI7NBA motherboard. The layout of the board in Figure 1 shows the location of the key components. The topics covered in this chapter are as follows:

3.1 Processor	7
3.2 L2 Cache	7
3.3 Main Memory	7
3.4 BIOS.....	9
3.5 I/O Port Address Map.....	9
3.6 DMA Channels	10
3.7 Interrupt Request (IRQ) Lines	10
3.8 Onboard PCI-IDE.....	10
3.9 Onboard Multi-I/O	11
3.10 Onboard AGP Slot.....	11
3.11 Hardware Monitoring IC	11
3.12 Onboard Audio	11

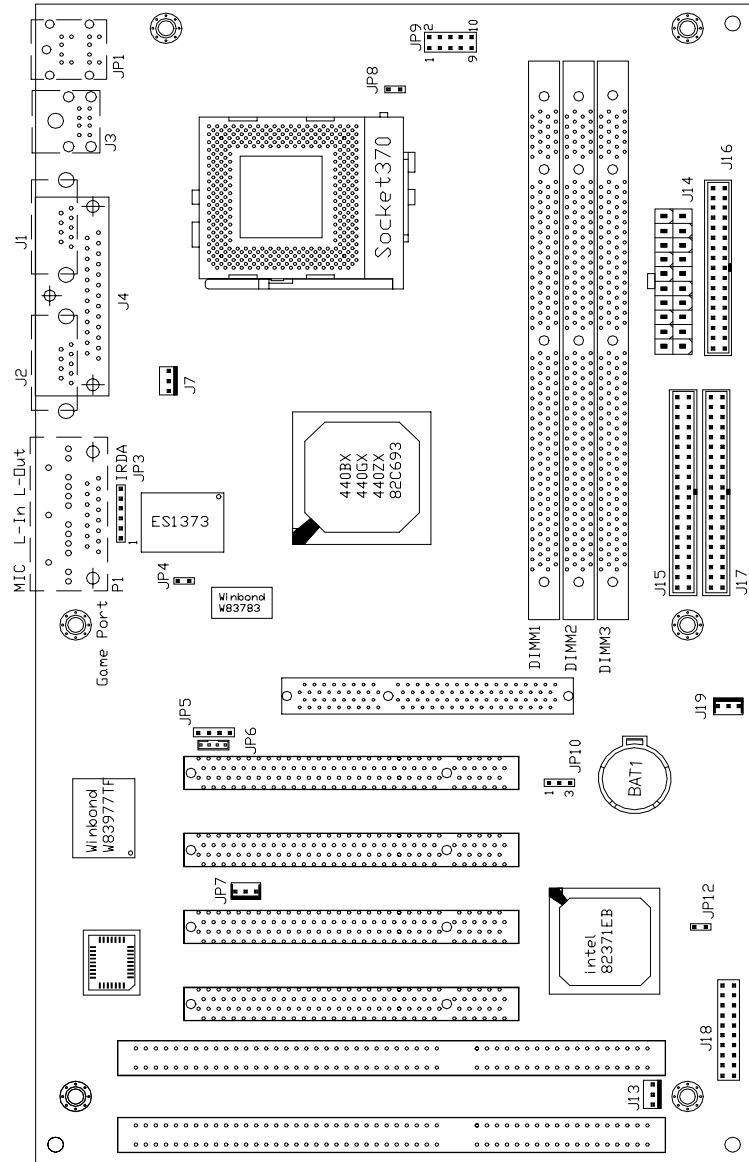

Figure 1: Layout of the TI7NBA Motherboard

3.1 Processor

The TI7NBA motherboard is designed to take an Intel Celeron/Mendocino processors running 333~533MHz at 66MHz CPU bus speed or 300/350/400/600MHz at 100MHz CPU host frequency with its Socket 370 processor connector.

3.2 L2 Cache

The L2 cache is integrated in the Pentium II processor. The private L2 cache bus is not connected to package pins; rather its signals are routed between the two cavities using standard package techniques.

3.3 Main Memory

The TI7NBA motherboard supports three 168-pin DIMM (Dual In-line Memory Module) sockets to form a memory configuration from 8MB to 384MB. DIMM modules can be 8MB, 16MB, 32MB, 64MB and 128MB in SDRAM DRAM. In populating the DIMM sockets, DIMM1, DIMM2 and DIMM3 bank can be populated first. Refer to the following table on how to configure the memory.

NOTE: Use SDRAM modules with PC100 specification when running 100MHz CPU bus speed. With 66MHz CPU bus speed, SDRAM modules with PC66 or PC100 specification can be used.

168-pin DIMM (3.3V) Unbuffer SDRAM

(DIMM3)	(DIMM2)	(DIMM1)	Total Memory
8MB	-----	-----	8MB
16MB	-----	-----	16MB
32MB	-----	-----	32MB
64MB	-----	-----	64MB
128MB	-----	-----	128MB
8MB	8MB	-----	16MB
16MB	8MB	-----	24MB
32MB	8MB	-----	40MB
64MB	8MB	-----	72MB
128MB	8MB	-----	136MB
8MB	8MB	8MB	24MB
16MB	8MB	8MB	32MB
32MB	8MB	8MB	48MB
64MB	8MB	8MB	80MB
128MB	8MB	8MB	144MB
16MB	16MB	-----	32MB
32MB	16MB	-----	48MB

(DIMM3)	(DIMM2)	(DIMM1)	Total Memory
64MB	16MB	-----	80MB
128MB	16MB	-----	144MB
16MB	16MB	8MB	40MB
32MB	16MB	8MB	56MB
64MB	16MB	8MB	88MB
128MB	16MB	8MB	152MB
16MB	16MB	16MB	48MB
32MB	16MB	16MB	64MB
64MB	16MB	16MB	96MB
128MB	16MB	16MB	160MB
32MB	32MB	-----	64MB
64MB	32MB	-----	96MB
128MB	32MB	-----	160MB
32MB	32MB	8MB	72MB
64MB	32MB	8MB	104MB
128MB	32MB	8MB	168MB
32MB	32MB	16MB	80MB
64MB	32MB	16MB	112MB
128MB	32MB	16MB	176MB
32MB	32MB	32MB	96MB
64MB	32MB	32MB	128MB
128MB	32MB	32MB	192MB
64MB	64MB	-----	128MB
128MB	64MB	-----	192MB
64MB	64MB	8MB	136MB
128MB	64MB	8MB	200MB
64MB	64MB	16MB	144MB
128MB	64MB	16MB	208MB
64MB	64MB	32MB	160MB
128MB	64MB	32MB	224MB
64MB	64MB	64MB	192MB
128MB	64MB	64MB	256MB
128MB	128MB	-----	320MB
128MB	128MB	8MB	264MB
128MB	128MB	16MB	272MB
128MB	128MB	32MB	288MB
128MB	128MB	64MB	320MB
128MB	128MB	128MB	384MB

3.4 BIOS

The BIOS on the TI7NBA motherboard provides the standard BIOS functions plus the following additional features:

1. ISA Plug and Play (PnP) Extension

Unlike PCI cards that are Plug and Play, ISA cards require setting jumpers to resolve hardware conflicts. To make a computer system PnP, an ISA PnP standard is established and supported by new operating systems, such as Windows 95. Under Windows 95, the motherboard BIOS must have an ISA PnP extension to support new ISA PnP cards.

2. Power Management

The power management feature provides power savings by slowing down the CPU clock, turning off the monitor screen and stopping the HDD spindle motor. The BIOS fully conforms to ACPI (Advanced Configuration and Power Interface) specification.

3.5 I/O Port Address Map

Each peripheral device in the system is assigned a set of I/O port addresses, which also becomes the identity of the device. There is a total of 1K port address space available. The following table lists the I/O port addresses used on the motherboard.

Address	Device Description
000h - 01Fh	DMA Controller #1
020h - 03Fh	Interrupt Controller #1
040h - 05Fh	Timer
060h - 06Fh	Keyboard Controller
070h - 07Fh	Real Time Clock,, NMI
080h - 09Fh	DMA Page Register
0A0h - 0BFh	Interrupt Controller #2
0C0h - 0DFh	DMA Controller #2
0F0h	Clear Math Coprocessor Busy Signal
0F1h	Reset Math Coprocessor
1F0h - 1F7h	IDE Interface
2F8h - 2FFh	Serial Port #2(COM2)
378h - 3FFh	Parallel Port #1(LPT1)
3F0h - 3F7h	Floppy Disk Controller
3F8h - 3FFh	Serial Port #1(COM1)

3.6 DMA Channels

There are seven DMA channels available on the motherboard. Only DMA2 is used by the floppy controller. In the case that ECP mode on the parallel port is utilized, DMA1 or DMA3 will be used.

3.7 Interrupt Request (IRQ) Lines

There are a total of 15 IRQ lines available on the motherboard. Peripheral devices use an interrupt request to notify the CPU for the service required. The following table shows the IRQ lines used by the devices on the motherboard:

<u>Level</u>	<u>Function</u>
IRQ0	System Timer Output
IRQ1	Keyboard
IRQ2	Interrupt Cascade
IRQ8	Real Time Clock
IRQ9	Software Redirected to Int 0Ah or PCI Slot Int#
IRQ10	Reserved or PCI Slot Int#
IRQ11	Reserved or PCI Slot Int#
IRQ12	PS/2 Mouse or PCI Slot Int#
IRQ13	Co-Processor
IRQ14	Primary IDE
IRQ15	Secondary IDE
IRQ3	Serial Port #2
IRQ4	Serial Port #1
IRQ5	Parallel Port #2 or PCI Slot Int#
IRQ6	Floppy Disk Controller
IRQ7	Parallel Port #1

3.8 Onboard PCI-IDE

The PCI-IDE controller is a part of the 82440BX or VIA 82C693 chipset. It supports PIO mode 3/4 and bus mastering Ultra DMA/33. The peak transfer rate of PIO mode 3/4 can be as high as 17MB/sec. Using HDDs that support Ultra DMA/33, the peak transfer rate can reach 33MB/sec. There are two IDE connectors - primary IDE and secondary IDE. With two devices per connector, up to four IDE devices can be supported.

3.9 Onboard Multi-I/O

The onboard multi-I/O chip, W83977TF, supports a keyboard controller (AMI copyright), two serial ports, one parallel port, one floppy controller and one IrDA port. The serial ports are 16550 UART compatible. The parallel port features high-speed EPP/ECP mode. The floppy controller supports up to 2.88MB format.

3.10 Onboard AGP Slot

The AGP (Accelerated Graphics Port) slot supports AGP compliant VGA cards to achieve rich 3D and video graphics display. AGP is a platform bus specification that enables 3D graphics capabilities including support for z-buffering, alpha blending and faster texture mapping.

3.11 Hardware Monitoring IC

The TI7NBA comes with the Winbond W83783 hardware monitoring IC. It monitors several hardware parameters including power supply voltages, fan speeds, and temperatures, which are very important for a high-end computer system to work stable and properly.

3.12 Onboard Audio

The onboard audio consists of the Creative ES1373 Chip + AC97. With a PCI Bus Mastering interface with DOS compatibility, it supports 32 voices wavetable, surround sound, 3D audio, and audio effects such as reverb and chorus. Creative ES1373 uses single, shareable PCI interrupt and is PC97/PC98 compliant. *The onboard audio shares the same interrupt with PCI2 slot, INTB#.*



This page was intentionally left blank.

Chapter 4 Configuring the Motherboard

The following sections describe the necessary procedures and proper jumper settings to configure the TI7NBA motherboard. For the locations of the jumpers, refer to Figure 2.

4.1 CPU Frequency/Speed Setting	15
4.2 Clear CMOS Select: JP10	15
4.3 Bus Speed Select: JP8	16

The following examples show the conventions used in this chapter.

	Jumper Open
	Jumper Closed/Short

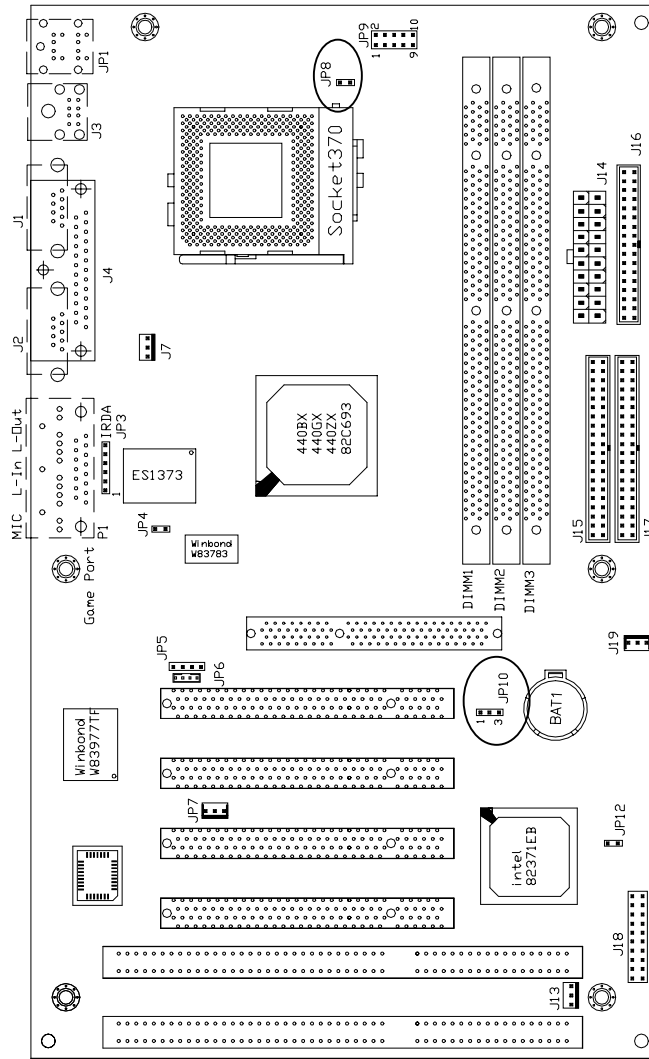

Figure 2: Jumper Location on the TI7NBA

4.1 CPU Frequency/Speed Setting

The motherboard allows users to set the CPU speed through the BIOS. The parameters in setting the CPU speed include **CPU Clock Multiplier** (X3, X3.5, X4, X4.5, X5, X5.5, X6.5, X7, X7.5, X8) and **CPU/PCI Clock Select** (66/33MHz, 75/37MHz, 83/41MHz or 100/33MHz, 103/34MHz, 105/35MHz, 110/36MHz, 112/37MHz, 115/38MHz, 120/40MHz, 124/41MHz, 124/31MHz, 133/44MHz, 133/33MHz, 140/35MHz, 150/37MHz). The parameters only appear when CPU Speed is set to *Manual*.

NOTE: Processors with locked/fixed frequencies will have a fixed CPU Clock Multiplier and will not allow changes to its value.

Aside from the *Manual* option, CPU Speed can be set to 200MHz (66x3), 233MHz (66x3.5), 266MHz (66x4), 300MHz (66x4.5), 333MHz (66x5), 366MHz (66x5.5), 400MHz (66x6), and 433MHz (66x6.5). Press the ↑ and ↓ keys to change the CPU speed or press the PageUp or PageDown key to see the selections for CPU Clock Multiplier and CPU Clock.

NOTE: Overclocking could cause the system not to boot. When this happens, turn off the computer by pressing the power button and turn it on again by pressing the **Insert** key and the power button simultaneously. Then press the **Delete** key to enter BIOS Setup and configure the CPU speed.

4.2 Clear CMOS Select: JP10

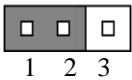
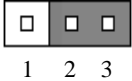

Use JP10, a 3-pin header, to clear the contents of the CMOS RAM. Do not clear the CMOS RAM unless it is absolutely necessary. You will lose your password, etc.

JP10	Jumper Setting	Function
 1 2 3	pin 1-2: short	Normal
 1 2 3	pin 2-3: short	Clear CMOS

NOTE: To clear CMOS, the ATX-power connector should be disconnected from the motherboard.

4.3 Bus Speed Select: JP8

Use JP8, a 2-pin header, to configure the bus speed at 100MHz or by CPU Auto Detect.

JP8	Jumper Setting	Function
	open	100MHz bus speed
	short	CPU Auto Detect

Chapter 5 Installation

This chapter describes the interface that the TI7NBA provides for creating a working system. Refer to Figure 3 for the location of the connectors.

The following items are covered in this chapter:

5.1 I/O Connectors	19
5.2 JP1: PS/2 Keyboard and PS/2 Mouse Connectors.....	19
5.3 J1, J2: Serial Ports	20
5.4 J4: Parallel Port Connector.....	20
5.5 P1: Line Out/Line In/ Microphone, Game Port	21
5.6 JP3: IrDA Connector	21
5.7 JP5, JP6: CD-ROM Audio In Connectors	21
5.8 JP7: Wake on LAN Connector	22
5.9 J7: CPU Fan Power Connector.....	22
5.10 J13: Chassis Fan Power Connector.....	22
5.11 J19: AGP Fan Power Connector.....	22
5.12 J14: ATX Power Supply Connector	23
5.13 J16: Floppy Drive Connector	23
5.14 J17, J15: EIDE Connectors	23
5.15 J18: Front Bezel Connectors	25

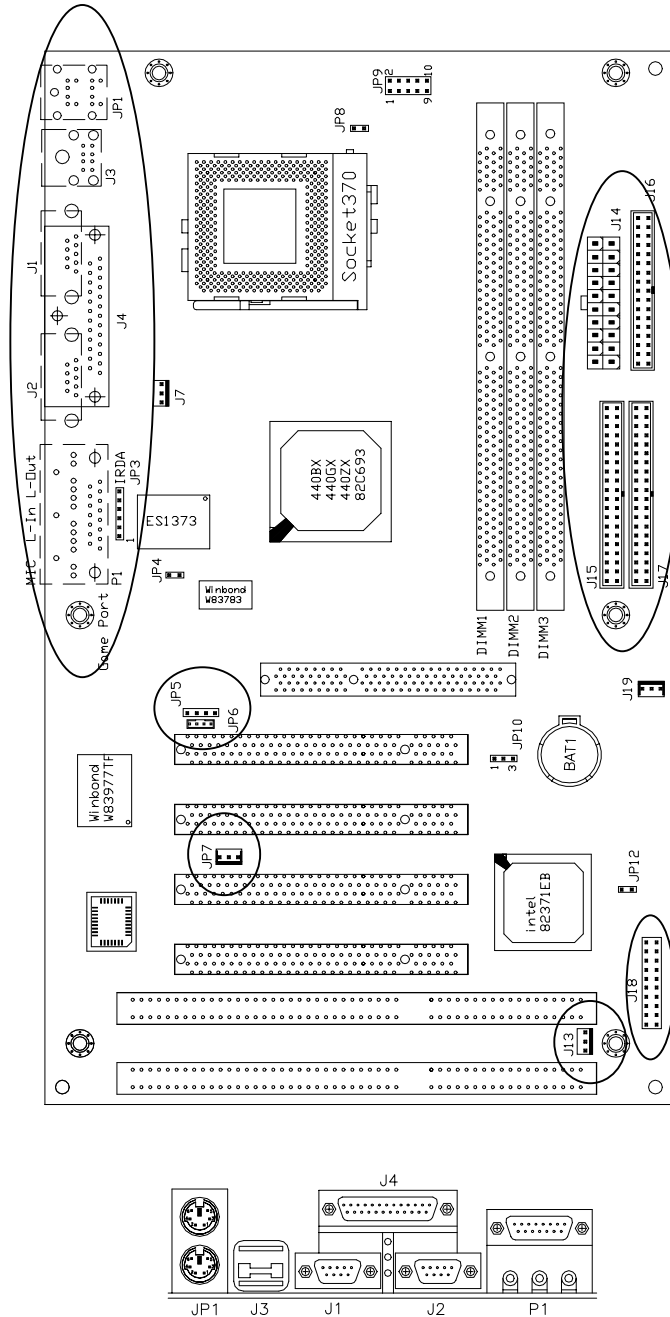

Figure 3: Connector Location on the TI7NBA

5.1 I/O Connectors

The I/O connectors connect the TI7NBA to the most common peripherals. To attach cables to these connectors, carefully align Pin 1 of the cables to that of the connectors. Refer to Figure 4 for the location and orientation of the connectors.

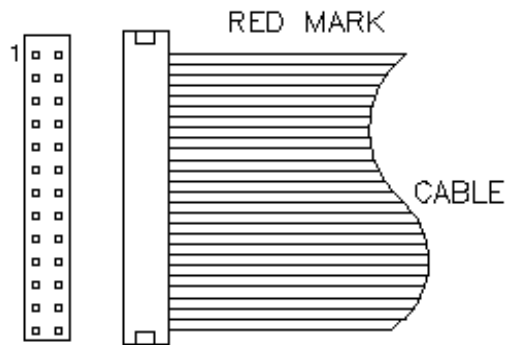
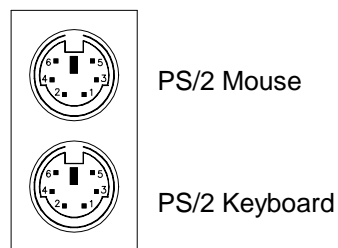

Figure 4: Orientation of the I/O Connector

5.2 JP1: PS/2 Keyboard and PS/2 Mouse Connectors



Below are the pin-out assignments of the connectors.

Signal Name	Keyboard	Mouse	Signal Name
Keyboard data	1	1	Mouse data
N.C.	2	2	N.C.
GND	3	3	N.C.
5V	4	4	5V
Keyboard clock	5	5	Mouse Clock
N.C.	6	6	N.C.

5.3 J1, J2: Serial Ports

The onboard serial ports of the TI7NBA, J1 and J2, are two DB-9 external connectors. The following table shows the pin-out assignments of these connectors.

Signal Name	Pin #	Pin #	Signal Name
DCD, Data carrier detect	1	6	DSR, Data set ready
RXD, Receive data	2	7	RTS, Request to send
TXD, Transmit data	3	8	CTS, Clear to send
DTR, Data terminal ready	4	9	RI, Ring indicator
GND, ground	5	10	Not Used

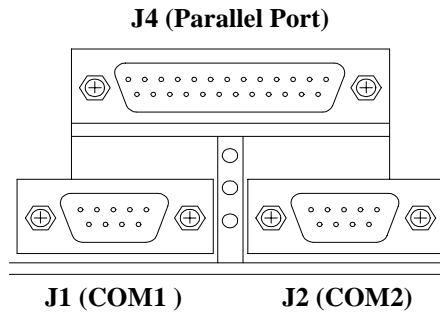

5.4 J4: Parallel Port Connector

J4 is a DB-25 external connector as seen in the above figure. The following table describes the pin- out assignments of this connector.

Signal Name	Pin #	Pin #	Signal Name
Line printer strobe	1	14	AutoFeed
PD0, parallel data 0	2	15	Error
PD1, parallel data 1	3	16	Initialize
PD2, parallel data 2	4	17	Select
PD3, parallel data 3	5	18	Ground
PD4, parallel data 4	6	19	Ground
PD5, parallel data 5	7	20	Ground
PD6, parallel data 6	8	21	Ground
PD7, parallel data 7	9	22	Ground
ACK, acknowledge	10	23	Ground
Busy	11	24	Ground
Paper empty	12	25	Ground
Select	13	N/A	N/A

5.5 P1: Line Out/Line In/ Microphone, Game Port

The connectors for Line Out, Line In, Microphone, and Game Port are features supported by the on board Creative Labs ES1373 audio chipset.

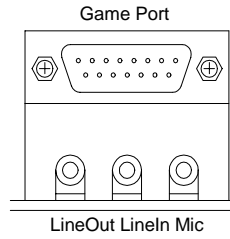

5.6 JP3: IrDA Connector

This connector is used for an IrDA connector that supports infrared wireless communication.

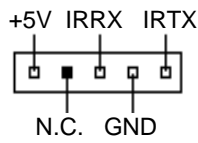

JP3 Pin #	Signal Name
1	+5V
2	No connect
3	Ir RX
4	Ground
5	Ir TX

5.7 JP5, JP6: CD-ROM Audio In Connectors

JP5 and JP6 are the onboard CD-ROM audio in connectors. Below are their pin assignments.

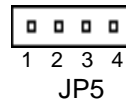
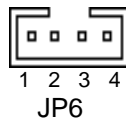

Signal Name	Pin #	Pin #	Signal Name
Ground	1	1	Left
Left	2	2	Ground
Ground	3	3	Ground
Right	4	4	Right

5.8 JP7: Wake on LAN Connector

JP7 is a 3-pin header for the Wake on LAN function on the motherboard. The following table shows the pin out assignments of this connector. Wake on LAN will function properly only with an ATX power supply with 5VSB that has 200mA.

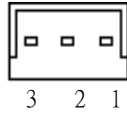

Pin #	Signal Name
1	+5VSB
2	Ground
3	Wake on LAN

5.9 J7: CPU Fan Power Connector

J7 is a 3-pin header for the CPU fan power connector. The fan must be a 12V fan.

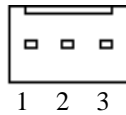

Pin #	Signal Name
1	Rotation
2	+12V
3	Ground

5.10 J13: Chassis Fan Power Connector

J13 is a 3-pin header for the CPU fan power connector. The fan must be a 12V fan.

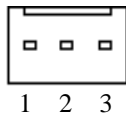

Pin #	Signal Name
1	Rotation
2	+12V
3	Ground

5.11 J19: AGP Fan Power Connector

J19 is a 3-pin header for the AGP fan power connector. The fan must be a 12V fan.

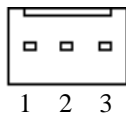

Pin #	Signal Name
1	Rotation
2	+12V
3	Ground

5.12 J14: ATX Power Supply Connector

J14 is a 20-pin ATX power supply connector. Refer to the following table for the pin out assignments. (Use an ATX power supply with 3.3V power.)

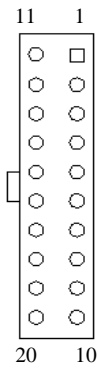

Signal Name	Pin #	Pin #	Signal Name
3.3V	11	1	3.3V
-12V	12	2	3.3V
Ground	13	3	Ground
PS-ON	14	4	+5V
Ground	15	5	Ground
Ground	16	6	+5V
Ground	17	7	Ground
-5V	18	8	Power good
+5V	19	9	5VSB
+5V	20	10	+12V

5.13 J16: Floppy Drive Connector

J16 of the TI7NBA is a 34-pin header and will support up to 2.88MB floppy drives. The following table shows its pin-out assignments.

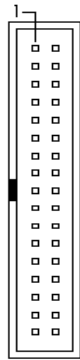

Signal Name	Pin #	Pin #	Signal Name
Ground	1	2	RM/LC
Ground	3	4	No connect
Ground	5	6	No connect
Ground	7	8	Index
Ground	9	10	Motor enable 0
Ground	11	12	Drive select 1
Ground	13	14	Drive select 0
Ground	15	16	Motor enable 1
Ground	17	18	Direction
Ground	19	20	Step
Ground	21	22	Write data
Ground	23	24	Write gate
Ground	25	26	Track 00
Ground	27	28	Write protect
Ground	29	30	Read data
Ground	31	32	Side 1 select
Ground	33	34	Diskette change

5.14 J17, J15: EIDE Connectors

J17: Primary IDE Connector

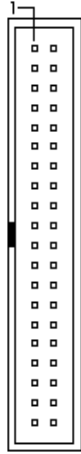

Signal Name	Pin #	Pin #	Signal Name
Reset IDE	1	2	Ground
Host data 7	3	4	Host data 8
Host data 6	5	6	Host data 9
Host data 5	7	8	Host data 10
Host data 4	9	10	Host data 11
Host data 3	11	12	Host data 12
Host data 2	13	14	Host data 13
Host data 1	15	16	Host data 14
Host data 0	17	18	Host data 15
Ground	19	20	Key
DRQ0	21	22	Ground
Host IOW	23	24	Ground
Host IOR	25	26	Ground
IOCHRDY	27	28	Host ALE
DACK0	29	30	Ground
IRQ14	31	32	No connect
Address 1	33	34	No connect
Address 0	35	36	Address 2
Chip select 0	37	38	Chip select 1
Activity	39	40	Ground

J15: Secondary IDE Connector

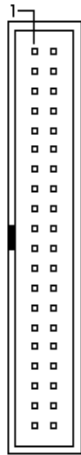

Signal Name	Pin #	Pin #	Signal Name
Reset IDE	1	2	Ground
Host data 7	3	4	Host data 8
Host data 6	5	6	Host data 9
Host data 5	7	8	Host data 10
Host data 4	9	10	Host data 11
Host data 3	11	12	Host data 12
Host data 2	13	14	Host data 13
Host data 1	15	16	Host data 14
Host data 0	17	18	Host data 15
Ground	19	20	Key
DRQ0	21	22	Ground
Host IOW	23	24	Ground
Host IOR	25	26	Ground
IOCHRDY	27	28	Host ALE
DACK1	29	30	Ground
MIRQ0	31	32	No connect
Address 1	33	34	No connect
Address 0	35	36	Address 2
Chip select 0	37	38	Chip select 1
Activity	39	40	Ground

5.15 J18: Front Bezel Connectors

The front bezel of the case has a control panel, which provides light indication of the computer activities and switches to change the computer status. J18 is a 20-pin header that provides interfaces for the following functions.

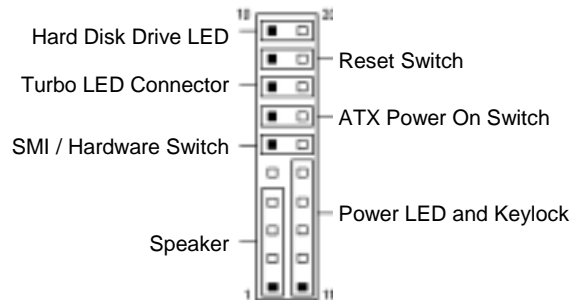

Speaker: Pins 1 - 4

This connector provides an interface to a speaker for audio tone generation. An 8-ohm speaker is recommended.



Pin #	Signal Name
1	Speaker out
2	No connect
3	Ground
4	+5V

Power LED and Keylock: Pins 11 - 15

The power LED indicates the status of the main power switch. The keylock switch, when closed, will disable the keyboard function.



Pin #	Signal Name
11	Power LED
12	No connect
13	Ground
14	Keylock
15	Ground

SMI/Hardware Switch: Pins 6 and 16

This connector supports the "Green Switch" on the control panel, which, when pressed, will force the system board into the power-saving mode immediately.

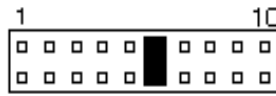

Pin #	Signal Name
6	Sleep
16	Ground

ATX Power ON Switch: Pins 7 and 17

This 2-pin connector is an "ATX Power Supply On/Off Switch" on the motherboard that connects to the power switch on the case. When pressed, the power switch will force the motherboard to power on. When pressed again, it will force the motherboard to power off.



Turbo LED Connector: Pins 8 and 18

There is no turbo/deturbo function on the motherboard. The Turbo LED on the control panel will always be On when attached to this connector.

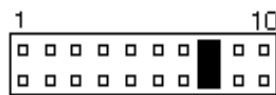

Pin #	Signal Name
8	5V
18	Ground

Reset Switch: Pins 9 and 19

The reset switch allows the user to reset the system without turning the main power switch Off and then On. Orientation is not required when making a connection to this header.

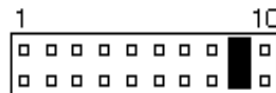

Hard Disk Drive LED Connector: Pins 10 and 20

This connector connects to the hard drive activity LED on control panel. This LED will flash when the HDD is being accessed.

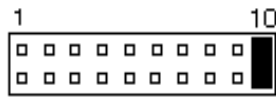

Pin #	Signal Name
10	Ground
20	5V

This page was intentionally left blank.

Chapter 6 BIOS and System Setup

This chapter describes the different settings available in the Award BIOS. The topics covered in this chapter are as follows:

6.1 BIOS Introduction	32
6.2 BIOS Setup.....	32
6.3 Standard CMOS Setup	34
Date	
Time	
Primary HDDs / Secondary HDDs	
Drive A / Drive B	
Video	
Halt On	
6.4 BIOS Features Setup	37
Virus Warning	
CPU Internal Cache / External Cache	
CPU L2 Cache ECC Checking	
Quick Power On Self Test	
Boot Sequence	
Swap Floppy Drive	
Boot Up Floppy Seek	
Boot Up NumLock Status	
Boot Up System Speed	
Gate A20 Option	
Typematic Rate Setting	
Typematic Rate (Chars/Sec)	
Typematic Delay (Msec)	
Security Option	
PCI/VGA Palette Snoop	
OS Select for DRAM > 64MB	
HDD S.M.A.R.T. capability	
Report No FDD for WIN 95	
Video BIOS Shadow	
C8000 - CBFFF Shadow/DC000 - DFFFF Shadow	
6.5 Chipset Features Setup	41
SDRAM RAS-to-CAS Delay	
SDRAM RAS Precharge Time	
SDRAM CAS Latency Time	
Bank DRAM Timing	

DRAM Clock	
SDRAM Precharge Control	
SDRAM Cycle Length	
Memory Hole	
Read Around Write	
Concurrent PCI/Host	
Video RAM Cacheable	
DRAM Data Integrity Mode	
System BIOS Cacheable	
Video BIOS Cacheable	
Video RAM Cacheable	
8 Bit I/O Recovery Time	
16 Bit I/O Recovery Time	
Memory Hole at 15MB - 16MB	
Passive Release	
Delayed Transaction	
AGP Aperture Size (MB)	
Auto Detect DIMM/PCI Clk	
Spread Spectrum	
6.6 Power Management Setup	46
ACPI function	
Power Management	
PM Control by APM	
Video Off Method	
Video Off After	
Video Off Option	
Modem Use IRQ	
Doze Mode	
Standby Mode	
Suspend Mode	
HDD Power Down	
Throttle Duty Cycle	
PCI/VGA Act-Monitor	
Soft-Off by PWR-BTTN	
Resume by Alarm	
IRQ 8 Break Suspend	
Reload Global Timer Events	
PM Events	
6.7 PNP/PCI Configuration	50
PNP OS Installed	
Resources Controlled by	

Reset Configuration Data	
IRQ3/4/5/7/9/10/11/12/14/15, DMA0/1/3/5/6/7 assigned to CPU to PCI Write Buffer	
PCI Dynamic Bursting	
PCI Master 0 WS Write	
PCI Delay Transaction	
PCI#2 Access #1 Retry	
AGP Master 1 WS Write	
AGP Master 1 WS Read	
PCI IRQ Activated by Assign IRQ for USB/VGA	
6.8 Load BIOS Defaults	53
6.9 Load Setup Defaults	53
6.10 CPU Speed Setting	54
CPU Speed, CPU Clock Multiplier, CPU/PCI Clock Select	
CPU Warning Temperature	
Current System / CPU Temp.	
Current CPU /Chassis / VGA Fan Speed	
Vcore / +5V / +3.3V / -12V / +12V	
CPU /Chassis / VGA Fan Monitor	
Shutdown Temperature	
6.11 Integrated Peripherals	56
IDE HDD Block Mode	
IDE Primary/Secondary Master/Slave PIO	
IDE Primary/Secondary Master/Slave UDMA	
On-Chip Primary/Secondary PCI IDE	
OnChip IDE Channel0/1	
USB Keyboard Support	
Init AGP Display First	
Power On Function	
Onboard FDC Controller	
Onboard Serial/Parallel Port	
UART Mode Select	
Parallel Port Mode	
6.12 Supervisor / User Password	59
6.13 IDE HDD Auto Detection	60
6.14 Save & Exit Setup	61
6.15 Exit Without Saving	61

6.1 BIOS Introduction

The Award BIOS (Basic Input/Output System) installed in your computer system's ROM supports Intel Pentium II processors. The BIOS provides critical low-level support for standard devices such as disk drives, serial ports, and parallel ports. It also adds virus and password protection as well as special support for detailed fine-tuning of the chipset controlling the entire system.

6.2 BIOS Setup

The Award BIOS provides a Setup utility program for specifying the system configurations and settings. The BIOS ROM of the system stores the Setup utility. When you turn on the computer, the Award BIOS is immediately activated. Pressing the key immediately allows you to enter the Setup utility. If you are a little bit late pressing the key, POST (Power On Self Test) will continue with its test routines, thus preventing you from invoking the Setup. If you still wish to enter Setup, restart the system by pressing the "Reset" button or simultaneously pressing the <Ctrl>, <Alt> and <Delete> keys. You can also restart by turning the system Off and back On again. The following message will appear on the screen:

Press to Enter Setup

In general, you press the arrow keys to highlight items, <Enter> to select, the <PgUp> and <PgDn> keys to change entries, <F1> for help and <Esc> to quit.

When you enter the Setup utility, the Main Menu screen will appear on the screen. The Main Menu allows you to select from various setup functions and exit choices.

ROM PCI/ISA BIOS
CMOS SETUP UTILITY
AWARD SOFTWARE, INC.

STANDARD CMOS SETUP	CPU SPEED SETTING
BIOS FEATURES SETUP	INTEGRATED PERIPHERALS
CHIPSET FEATURES SETUP	SUPERVISOR PASSWORD
POWER MANAGEMENT SETUP	USER PASSWORD
PNP/PCI CONFIGURATION	IDE HDD AUTO DETECTION
LOAD BIOS DEFAULTS	SAVE & EXIT SETUP
LOAD SETUP DEFAULTS	EXIT WITHOUT SAVING
ESC : Quit	↑ ↓ → ← : Select Item
F10 : Save & Exit Setup	(Shift) F2 : Change Color
Time, Date, Hard Disk Type	

(For Intel 82440BX /ZX/GX or VIA 82C693)

The section below the setup items of the Main Menu displays the control keys for this menu. Another section at the bottom of the Main Menu just below the control keys section displays information on the currently highlighted item in the list.

NOTE: *After making and saving system changes with Setup, you find that your computer cannot boot, the Award BIOS supports an override to the CMOS settings that resets your system to its default.*

We strongly recommend that you avoid making any changes to the chipset defaults. These defaults have been carefully chosen by both Award and your system manufacturer to provide the absolute maximum performance and reliability.

6.3 Standard CMOS Setup

“Standard CMOS Setup” choice allows you to record some basic hardware configurations in your computer system and set the system clock and error handling. If the motherboard is already installed in a working system, you will not need to select this option. You will need to run the Standard CMOS option, however, if you change your system hardware configurations, the onboard battery fails, or the configuration stored in the CMOS memory was lost or damaged.

ROM PCI/ISA BIOS STANDARD CMOS SETUP AWARD SOFTWARE, INC.								
Date (mm:dd:yy) : Wed, Mar 4 1998								
Time (hh:mm:ss) : 00 : 00 : 00								
HARD DISKS	TYPE	SIZE	CYLS	HEAD	PRECOMP	LANDZ	SECTOR	MODE
Primary Master	Auto	0	0	0	0	0	0	Auto
Primary Slave	Auto	0	0	0	0	0	0	Auto
Secondary Master	Auto	0	0	0	0	0	0	Auto
Secondary Slave	Auto	0	0	0	0	0	0	Auto
Drive A	: 1.44M, 3.5in							
Drive B	: None							
Video	: EGA / VGA							
Halt On	: All Errors							
			Base Memory			: 640K		
			Extended Memory			: 15360K		
			Other Memory			: 384K		
			Total Memory			: 16384K		
ESC : Quit			↑ ↓ → ← : Select			Item PU / PD / + / - : Modify		
F1 : Help			(Shift) F2 : Change Color					

(For Intel 82440BX /ZX/GX or VIA 82C693)

At the bottom of the menu are the control keys for use on this menu. If you need any help in each item field, you can press the <F1> key. It will display the relevant information to help you. The memory display at the lower right-hand side of the menu is read-only. It will adjust automatically according to the memory changed. The following describes each item of this menu.

Date

The date format is:

Day : Sun to Sat
Month : 1 to 12
Date : 1 to 31
Year : 1994 to 2079

To set the date, highlight the “Date” field and use the PageUp/ PageDown or +/- keys to set the current time.

Time

The time format is: **Hour : 00 to 23**
Minute : 00 to 59
Second : 00 to 59

To set the time, highlight the “Time” field and use the <PgUp>/<PgDn> or +/- keys to set the current time.

Primary HDDs / Secondary HDDs

The onboard PCI IDE connectors provide Primary and Secondary channels for connecting up to four IDE hard disks or other IDE devices. Each channel can support up to two hard disks; the first is the “Master” and the second is the “Slave”.

To enter the specifications for a hard disk drive, you must select first a “Type”. There are 45 predefined types and 4 user definable types are for Enhanced IDE BIOS. Type 1 to 45 are predefined. Type “User” is user-definable. For the Primary Master/Slave as well as Secondary Master/Slave, you can select “Auto” under the TYPE and MODE fields. This will enable auto detection of your IDE drives and CD-ROM drive during POST.

Press <PgUp>/<PgDn> to select a numbered hard disk type or type the number and press the <Enter> key. The hard disk will not work properly if you enter incorrect information for this field. If your hard disk drive type is not matched or listed, you can use Type User to define your own drive type manually. If you select Type User, related information is asked to be entered to the following items.

CYLS : Number of cylinders
HEAD : Number of read/write heads
PRECOMP : Write precompensation
LANDZ : Landing zone
SECTOR : Number of sectors
SIZE : Automatically adjust according to the configuration
MODE (for IDE HDD only) : Auto
Normal (HD < 528MB)
Large (for MS-DOS only)
LBA (HD > 528MB and supports
Logical Block Addressing)

NOTE: The specifications of your drive must match with the drive table. The hard disk will not work properly if you enter incorrect information in these fields. If your hard disk drive type is not matched or listed, you can use Type User to define your own drive type manually.

Drive A / Drive B

These fields identify the types of floppy disk drive A or drive B that has been installed in the computer. The available specifications are:

360KB 1.2MB 720KB 1.44MB 2.88MB
5.25 in. 5.25 in. 3.5 in. 3.5 in. 3.5 in.

Video

This field selects the type of video display card installed in your system. You can choose the following video display cards:

EGA/VGA	For EGA, VGA, SEGA, SVGA or PGA monitor adapters. (default)
CGA 40	Power up in 40 column mode.
CGA 80	Power up in 80 column mode.
MONO	For Hercules or MDA adapters.

Halt On

This field determines whether the system will halt if an error is detected during power up.

No errors	The system boot will not be halted for any error that may be detected.
All errors	Whenever the BIOS detects a non-fatal error, the system will stop and you will be prompted.
All, But Keyboard	The system boot will not be halted for a keyboard error; it will stop for all other errors
All, But Diskette	The system boot will not be halted for a disk error; it will stop for all other errors.
All, But Disk/Key	The system boot will not be halted for a keyboard or disk error; it will stop for all others.

6.4 BIOS Features Setup

This section allows you to configure and improve your system and allows you to set up some system features according to your preference.

ROM / PCI ISA BIOS
BIOS FEATURES SETUP
AWARD SOFTWARE, INC.

Virus Warning	: Disabled	Video BIOS Shadow	: Enabled
CPU Internal Cache	: Enabled	C8000-CBFFF Shadow	: Disabled
External Cache	: Enabled	CC000-CFFFF Shadow	: Disabled
CPU L2 Cache ECC Checking	: Enabled	D0000-D3FFF Shadow	: Disabled
Quick Power On Self Test	: Enabled	D4000-D7FFF Shadow	: Disabled
Boot Sequence	: A, C, SCSI	D8000-DBFFF Shadow	: Disabled
Swap Floppy Drive	: Disabled	DC000-DFFF Shadow	: Disabled
Boot Up Floppy Drive	: Enabled		
Boot Up Numlock Status	: On		
Gate A20 Option	: Fast		
Typematic Rate Setting	: Disabled		
Typematic Rate (chars/Sec)	: 6		
Typematic Delay (Msec)	: 250		
Security Option	: Setup		
PCI /VGA Palette Snoop	: Disabled		
OS Select For DRAM>64MB	: Non-OS2	ESC : Quit	↑ ↓ → ← : Select Item
HDD S.M.A.R.T. capability	: Enabled	F1 : Help	PU/PD/+/- : Modify
Report No FDD For WIN 95	: Yes	F5 : Old Values	(Shift) F2 : Color
		F6 : Load BIOS Defaults	
		F7 : Load Setup Defaults	

(For Intel 82440BX /ZX/GX or VIA 82C693)

Virus Warning

This item protects the boot sector and partition table of your hard disk against accidental modifications. If an attempt is made, the BIOS will halt the system and display a warning message. If this occurs, you can either allow the operation to continue or run an anti-virus program to locate and remove the problem.

NOTE: *Many disk diagnostic programs which attempt to access the boot sector table can cause the virus warning. If you will run such a program, disable the Virus Warning feature.*

CPU Internal Cache / External Cache

Cache memory is additional memory that is much faster than conventional DRAM (system memory). CPUs from 486-type on up contain internal cache memory, and most, but not all, modern PCs have additional (external) cache memory. When the CPU requests data, the system transfers the requested data from the main DRAM into cache memory, for even faster access by the CPU. These items allow you to enable (speed up memory access) or disable the cache function. By default, these items are **Enabled**.

CPU L2 Cache ECC Checking

When enabled, this allows ECC checking of the CPU's L2 cache. By default, this field is *Enabled*.

Quick Power On Self Test

When enabled, this field speeds up the Power On Self Test (POST) after the system is turned on. If it is set to *Enabled*, BIOS will skip some items.

Boot Sequence

This field determines the drive that the system searches first for an operating system. The default value is *A, C, SCSI*. The options are :

A, C, SCSI	D, A, SCSI	SCSI, C, A
C, A, SCSI	E, A, SCSI	C only
C, CDROM, A	F, A, SCSI	LS/ZIP, C
CDROM, C, A	SCSI, A, C	

Swap Floppy Drive

This item allows you to determine whether to enable Swap Floppy Drive or not. When enabled, the BIOS swaps floppy drive assignments so that Drive A becomes Drive B, and Drive B becomes Drive A. By default, this field is set to *Disabled*.

Boot Up Floppy Seek

When enabled, the BIOS will seek whether or not the floppy drive installed has 40 or 80 tracks. 360K type has 40 tracks while 760K, 1.2M and 1.44M all have 80 tracks. By default, this field is set to *Enabled*.

Boot Up NumLock Status

This allows you to activate the NumLock function after you power up the system. By default, the system boots up with *NumLock* On.

Boot Up System Speed

This has no function and selects the default system speed (*High*).

Gate A20 Option

This field allows you to select how Gate A20 is worked. Gate A20 is a device used to address memory above 1 MB. The default setting is *Fast*.

Typematic Rate Setting

When disabled, continually holding down a key on your keyboard will generate only one instance. When enabled, you can set the two typematic controls listed next. By default, this field is set to *Disabled*.

Typematic Rate (Chars/Sec)

When the typematic rate is enabled, the system registers repeated keystrokes speeds. You can select speed range from 6 to 30 characters per second. By default, this item is set to **6**.

Typematic Delay (Msec)

When the typematic rate is enabled, this item allows you to set the time interval for displaying the first and second characters. By default, this item is set to **250msec**.

Security Option

This field allows you to limit access to the System and Setup. The default value is **Setup**. When you select **System**, the system prompts for the User Password every time you boot up. When you select **Setup**, the system always boots up and prompts for the Supervisor Password only when the Setup utility is called up.

PCI/VGA Palette Snoop

Some non-standard VGA display cards may not show colors properly. This field allows you to set whether MPEG ISA/VESA VGA Cards can work with PCI/VGA or not. When this field is enabled, a PCI/VGA can work with a MPEG ISA/VESA VGA card. When this field is disabled, a PCI/VGA cannot work with a MPEG ISA/VESA Card.

OS Select for DRAM > 64MB

This option allows the system to access greater than 64MB of DRAM memory when used with OS/2 that depends on certain BIOS calls to access memory. The default setting is **Non-OS/2**.

HDD S.M.A.R.T. capability

This option enables or disables the S.M.A.R.T. (Self-Monitoring, Analysis, and Reporting Technology) capability hard disks.

Report No FDD for WIN 95

This option allows Windows 95 to share with other peripherals IRQ6 that is assigned to a floppy disk drive if the drive is not existing. The default setting is **No**.

Video BIOS Shadow

This item allows you to change the Video BIOS location from ROM to RAM. Video Shadow will increase the video speed.

C8000 - CBFFF Shadow/DC000 - DFFFF Shadow

Shadowing a ROM reduces the memory available between 640KB to 1024KB. These fields determine whether optional ROM will be copied to RAM or not.

6.5 Chipset Features Setup

This Setup menu controls the configuration of the motherboard chipset.

ROM PCI/ISA BIOS
CHIPSET FEATURES SETUP
AWARD SOFTWARE INC.

SDRAM RAS-to-CAS Delay : 3 SDRAM RAS Precharge Time : 3 SDRAM CAS Latency Timer : 3 SDRAM Precharge Control : Disabled DRAM Integrity Mode : Non-ECC System BIOS Cacheable : Disabled Video BIOS Cacheable : Enabled Video RAM Cacheable : Disabled 8 Bit I/O Recovery Time : 3 16 Bit I/O Recovery Time : 2 Memory Hole At 15MB-16MB : Disabled Passive Release : Enabled Delayed Transaction : Disabled AGP Aperture Size (MB) : 64 Auto Detect DIMM/PCI Clk : Disabled Spread Spectrum : Disabled	ESC : Quit F1 : Help F5 : Old Values F6 : Load BIOS Defaults F7 : Load Setup Defaults ↑ ↓ → ← : Select Item PU/PD/+/- : Modify (Shift) F2 : Color
---	--

(For Intel 82440BX/ZX/GX)

ROM PCI/ISA BIOS
CHIPSET FEATURES SETUP
AWARD SOFTWARE INC.

Bank 0/1 DRAM Timing : SDRAM 10ns Bank 2/3 DRAM Timing : SDRAM 10ns Bank 4/5 DRAM Timing : SDRAM 10ns SDRAM Cycle Length : 3 DRAM CLOCK : Host CLK Memory Hole : Disabled Read Around Write : Disabled Concurrent PCI/Host : Disabled Video RAM Cacheable : Disabled AGP Aperture Size (MB) : 64 Auto Detect DIMM/PCI Clk : Disabled Spread Spectrum : Disabled	ESC : Quit F1 : Help F5 : Old Values F6 : Load BIOS Defaults F7 : Load Setup Defaults ↑ ↓ → ← : Select Item PU/PD/+/- : Modify (Shift) F2 : Color
--	--

(For VIA 82C693)

SDRAM RAS-to-CAS Delay

When DRAM is refreshed, both rows and columns are addressed separately. This field allows you to determine the timing of transition from Row Address Strobe (RAS) to Column Address Strobe (CAS).

SDRAM RAS Precharge Time

The precharge time is the number of cycles it takes for the RAS to accumulate its charge before DRAM refresh. If insufficient time is allowed, refresh may be incomplete and the DRAM may fail to retain data.

SDRAM CAS Latency Time

When synchronous DRAM is installed, the number of clock cycles of CAS latency depends on the DRAM timing. Do not reset this field from the default value specified by the system designer.

Bank DRAM Timing

These fields define the speed of the DRAM memory onboard. The options are *Normal*, *Medium*, *Fast*, *Turbo*, *SDRAM 8ns* and *SDRAM10ns*. By default, these fields are set to *SDRAM 10ns*.

DRAM Clock

The DRAM Clock can be set to Host CLK or the CPU clock itself and to *66MHz*. By default, this field is set to *Host CLK*.

SDRAM Precharge Control

This field enables or enables the SDRAM Precharge Control.

SDRAM Cycle Length

This field sets the SDRAM cycle length to either 2 or 3. The default setting is 3.

Memory Hole

In order to improve performance, certain space in memory can be reserved for ISA cards. This field allows you to reserve 15MB to 16MB memory address space to ISA expansion cards. This makes memory from 15MB and up unavailable to the system. Expansion cards can only access memory up to 16MB. By default, this field is set to *Disabled*.

Read Around Write

DRAM optimization feature: If a memory read is addressed to a location whose latest write is being held in a buffer before being written to memory, the read is satisfied through the buffer contents, and the read is not sent to the DRAM. The default setting is *Enabled*.

Concurrent PCI/Host

This field enables or disables the concurrent PCI/Host. The default setting is *Disabled*.

Video RAM Cacheable

Selecting *Enabled* allows caching of the video BIOS ROM at C0000h to C7FFFh, resulting in better video performance. However, if any program writes to this memory area, a memory access error may result.

DRAM Data Integrity Mode

Set this field to *ECC* if the DRAM installed in the system supports it. Otherwise, do not reset the default of *Non-ECC*.

System BIOS Cacheable

When enabled, access to the system BIOS ROM addressed at F0000H-FFFFFH is cached, provided that the cache controller is disabled.

Video BIOS Cacheable

When enabled, access to video BIOS addressed at C0000H to C7FFFH is cached, provided that the cache controller is disabled.

Video RAM Cacheable

Selecting *Enabled* allows caching of the video BIOS ROM at C0000h to C7FFFh, resulting in better video performance. However, if any program writes to this memory area, a memory access error may result.

8 Bit I/O Recovery Time

This option specifies the length of the delay (in sysclks) inserted between consecutive 8-bit I/O operations. The settings are 1, 2, 3, 4, 5, 6, 7, or 8. The default setting is 3.

16 Bit I/O Recovery Time

This option specifies the length of the delay (in sysclks) inserted between consecutive 16-bit I/O operations. The settings are 1, 2, 3, 4, 5, 6, 7, or 8. The default setting is 2.

Memory Hole at 15MB - 16MB

In order to improve performance, certain space in memory can be reserved for ISA cards. This field allows you to reserve 15MB to 16MB memory address space to ISA expansion cards. This makes memory from 15MB and up unavailable to the system. Expansion cards can only access memory up to 16MB. By default, this field is set to *Disabled*.

Passive Release

When enabled, CPU to PCI bus accesses are allowed during passive release. Otherwise, the arbiter only accepts another PCI master access to local DRAM.

Delayed Transaction

The chipset has an embedded 32-bit posted write buffer to support delay transactions cycles. Select *Enabled* to support compliance with PCI specification version 2.1. The default setting is *Enabled*.

AGP Aperture Size (MB)

The field sets aperture size of the graphics. The aperture is a portion of the PCI memory address range dedicated for graphics memory address space. Host cycles that hit the aperture range are forwarded to the AGP without any translation. The options available are 4M, 8M, 16M, 32M, 64M, 128M and 256M. The default setting is *64M*.

Auto Detect DIMM/PCI Clk

When enabled, the system automatically shuts off clocks of unused DIMM/PCI slots. The default setting is *Disabled*. This field is for CE testing use only.

Spread Spectrum

This field sets the value of the spread spectrum. Options are Disabled, 1.8% (CNTR), 0.6% (CNTR), 1.8% (DOWN), and 0.6% (DOWN). The default setting is *Disabled*. This field is for CE testing use only.

6.6 Power Management Setup

The Power Management Setup allows you to save energy of your system effectively. It will shut down the hard disk and turn off video display after a period of inactivity.

ROM PCI/ISA BIOS
POWER MANAGEMENT SETUP
AWARD SOFTWARE, INC.

ACPI function	: Enabled	** Reload Global Timer Events **	
Power Management	: User Define	IRQ3 (3-7, 9-15), NMI	: Disabled
PM Control by APM	: Yes	Primary IDE 0	: Enabled
Video Off Method	: V/H SYNC +Blank	Primary IDE 1	: Enabled
Video Off After	: Standby	Secondary IDE 0	: Disabled
MODEM Use IRQ	: 3	Secondary IDE 1	: Disabled
		Floppy Disk	: Disabled
Doze Mode	: Disabled	Serial Port	: Enabled
Standby Mode	: Disabled	Parallel Port	: Disabled
Suspend Mode	: Disabled		
HDD Power Down	: Disabled		
Throttle Duty Cycle	: 62.5%		
VGA Active Monitor	: Enabled		
Soft-Off by PWR-BTTN	: Instant-Off		
Resume by Ring	: Disabled		
Resume by Alarm	: Disabled		
IRQ 8 Break Suspend	: Disabled		
		ESC : Quit	↑ ↓ → ← : Select Item
		F1 : Help	PU/PD/+/- : Modify
		F5 : Old Values	(Shift) F2 : Color
		F6 : Load BIOS Defaults	
		F7 : Load Setup Defaults	

(For Intel 82440BX/ZX/GX)

ROM PCI/ISA BIOS
POWER MANAGEMENT SETUP
AWARD SOFTWARE, INC.

ACPI Function	: Enabled	Primary INTR	: ON
Power Management	: User Define	IRQ3 (COM2)	: Primary
PM Control by APM	: Yes	IRQ4 (COM1)	: Primary
Video Off Option	: Suspend -> Off	IRQ5 (LPT 2)	: Primary
Video Off Method	: V/H SYNC +Blank	IRQ6 (Floppy Disk)	: Primary
Soft-Off by PWRBTN	: Instant-Off	IRQ7 (LPT 1)	: Primary
** PM Timers **		IRQ8 (RTC Alarm)	: Disabled
HDD Power Down	: Disabled	IRQ9 (IRQ2 Redir)	: Secondary
Doze Mode	: Disabled	IRQ10 (Reserved)	: Secondary
Suspend Mode	: Disabled	IRQ11 (Reserved)	: Secondary
** PM Events **		IRQ12 (PS/2 Mouse)	: Primary
VGA	: OFF	IRQ13 (Coprocesor)	: Primary
LPT & COM	: LPT / COM	IRQ14 (Hard Disk)	: Primary
HDD & FDD	: ON	IRQ15 (Reserved)	: Primary
DMA / master	: OFF		
PWR-On by Modem/LAN	: Disabled	ESC : Quit	↑ ↓ → ← : Select Item
RTC Alarm Resume	: Disabled	F1 : Help	PU/PD/+/- : Modify
		F5 : Old Values	(Shift) F2 : Color
		F6 : Load BIOS Defaults	
		F7 : Load Setup Defaults	

(For VIA 82C693)

ACPI function

ACPI stands for Advanced Configuration Power Interface. The default setting of this field *Enabled*.

Power Management

This field allows you to select the type of power saving management modes. There are four selections for Power Management.

- | | |
|-------------------|--|
| Min. Power Saving | Minimum power management |
| Max. Power Saving | Maximum power management. |
| User Define | Each of the ranges are from 1 min. to 1hr. Except for HDD Power Down which ranges from 1 min. to 15 min. (Default) |

NOTE: In order to enable the CPU overheat protection feature, the Power Management field should not be set to Disabled.

PM Control by APM

This field allows you to use the Advanced Power Management device to enhance the Max. Power Saving mode and stop the CPU's internal clock. If the Max. Power Saving is not enabled, this will be preset to NO.

Video Off Method

This field defines the Video Off features. There are three options.

V/H SYNC + Blank Default setting, blank the screen and turn off vertical and horizontal scanning.

DPMS Allows the BIOS to control the video display card if it supports the DPMS feature.

Blank Screen This option only writes blanks to the video buffer.

Video Off After

As the system moves from lesser to greater power-saving modes, select the mode in which you want the monitor to blank.

Video Off Option

This field determines the state at which video enters into when turned off. By default, this field is set to *Suspend -> Off*.

Modem Use IRQ

This field names the interrupt request (IRQ) line assigned to the modem (if any) on your system. Activity of the selected IRQ always awakens the system. By default, the IRQ is set to 3.

Doze Mode

When enabled, and after the set time of system inactivity, the CPU clock will run at a slower speed while all other devices still operate at full speed.

Standby Mode

After the selected period of system inactivity, the fixed disk drive and the video shut off while all other devices still operate at full speed.

Suspend Mode

When enabled, and after the set time of system inactivity, all devices except the CPU will be shut off.

HDD Power Down

When enabled, and after the set time of system inactivity, the hard disk drive will be powered down while all other devices remain active.

Throttle Duty Cycle

When the system enters Doze mode, the CPU clock runs only part of the time. You may select the percent of time that the clock runs.

PCI/VGA Act-Monitor

When enabled, any video activity restarts the global timer for Standby mode. The default setting is *Disabled*.

Soft-Off by PWR-BTTN

This field defines the power-off mode when using an ATX power supply. The Instant-Off mode allows powering off immediately upon pressing the power button. In the *Delay 4 Sec* mode, the system powers off when the power button is pressed for more than four seconds or places the system in a very low-power-usage state, with only enough circuitry receiving power to detect power button activity. The default value is *Instant-Off*.

Resume by Alarm

This allows a computer to be turned on automatically through the timer set in the BIOS to make the system more scheduleable. By default, this field is set to *Disabled*.

IRQ 8 Break Suspend

You can enable or disable the monitoring of IRQ 8 (Real Time Clock) so it does not awaken the system from Suspend mode.

Reload Global Timer Events

This section determines the reloading of the 'timers' after entering the Full On You can enable or disable the monitoring of IRQ 8 (Real Time Clock) so it does not awaken the system from Suspend mode.

PM Events

The VGA, LPT & COM, HDD & FDD, DMA /master, PWR-On by Modem/LAN, RTC Alarm Resume and Primary INTR section are I/O events which can prevent the system from entering a power saving mode or can awaken the system from such a mode. When an I/O device wants to gain the attention of the operating system, it signals this by causing an IRQ to occur. When the operating system is ready to respond to the request, it interrupts itself and performs the service. The default value is *Off*. When set On, activity will neither prevent the system from going into a power management mode nor awaken it. The IRQ section sets the wake-up call of the system. If activity is detected from any enabled IRQ channels in the left-hand group, the system wakes up from suspended mode.

6.7 PNP/PCI Configuration

This option configures the PCI bus system. All PCI bus systems on the system use INT#, thus all installed PCI cards must be set to this value.

ROM PCI/ISA BIOS
PNP/PCI CONFIGURATION
AWARD SOFTWARE INC.

PNP OS Installed	: Yes	Used MEM base addr	: N/A
Resources Controlled by	: Manual		
Reset Configuration Data	: Disabled		
IRQ-3 assigned to	: Legacy ISA		
IRQ-4 assigned to	: Legacy ISA		
IRQ-5 assigned to	: PCI/ISA PnP		
IRQ-7 assigned to	: Legacy ISA		
IRQ-9 assigned to	: PCI/ISA PnP		
IRQ-10 assigned to	: PCI/ISA PnP		
IRQ-11 assigned to	: PCI/ISA PnP		
IRQ-12 assigned to	: PCI/ISA PnP		
IRQ-14 assigned to	: PCI/ISA PnP		
IRQ-15 assigned to	: PCI/ISA PnP		
DMA-0 assigned to	: PCI/ISA PnP		
DMA-1 assigned to	: PCI/ISA PnP	ESC : Quit	↑ ↓ ← : Select Item
DMA-3 assigned to	: PCI/ISA PnP	F1 : Help	PU/PD/+/- : Modify
DMA-5 assigned to	: PCI/ISA PnP	F5 : Old Values	(Shift) F2 : Color
DMA-6 assigned to	: PCI/ISA PnP	F6 : Load BIOS Defaults	
DMA-7 assigned to	: PCI/ISA PnP	F7 : Load Setup Defaults	

(For Intel 82440BX/ZX/GX)

ROM PCI/ISA BIOS
PNP/PCI CONFIGURATION
AWARD SOFTWARE INC.

PNP OS Installed	: No	CPU to PCI Write Buffer	: Enabled
Resources Controlled by	: Manual	PCI Dynamic Bursting	: Enabled
Reset Configuration Data	: Disabled	PCI Master 0 WS Write	: Disabled
IRQ-3 assigned to	: Legacy ISA	PCI Delay Transaction	: Enabled
IRQ-4 assigned to	: Legacy ISA	PCI#2 Access #1 Retry	: Disabled
IRQ-5 assigned to	: PCI/ISA PnP	AGP Master 1 WS Write	: Enabled
IRQ-7 assigned to	: Legacy ISA	AGP Master 1 WS Read	: Disabled
IRQ-9 assigned to	: PCI/ISA PnP	PCI IRQ Activated By	: Level
IRQ-10 assigned to	: PCI/ISA PnP	Assign IRQ For USB	: Enabled
IRQ-11 assigned to	: PCI/ISA PnP	Assign IRQ For VGA	: Enabled
IRQ-12 assigned to	: PCI/ISA PnP		
IRQ-14 assigned to	: PCI/ISA PnP		
IRQ-15 assigned to	: PCI/ISA PnP		
DMA-0 assigned to	: PCI/ISA PnP		
DMA-1 assigned to	: PCI/ISA PnP	ESC : Quit	↑ ↓ ← : Select Item
DMA-3 assigned to	: PCI/ISA PnP	F1 : Help	PU/PD/+/- : Modify
DMA-5 assigned to	: PCI/ISA PnP	F5 : Old Values	(Shift) F2 : Color
DMA-6 assigned to	: PCI/ISA PnP	F6 : Load BIOS Defaults	
DMA-7 assigned to	: PCI/ISA PnP	F7 : Load Setup Defaults	

(For VIA 82C693)

PNP OS Installed

This field allows you to specify if the operating system installed in your system is plug and play aware.

NOTE: Operating systems such as DOS, OS/2, and Windows 3.x do not use PnP

Resources Controlled by

This PnP BIOS can configure all of the boot and compatible devices automatically. However, this capability needs you to use a PnP operating system such as Windows 95. The default value is *Manual*.

Reset Configuration Data

This field allows you to determine whether to reset the configuration data or not. The default value is *Disabled*.

IRQ3/4/5/7/9/10/11/12/14/15, DMA0/1/3/5/6/7 assigned to

These fields allow you to determine the IRQ/DMA assigned to the ISA bus and is not available to any PCI slot.

Used MEM base addr

Select a base address for the memory area used by any peripheral that requires high memory. The default setting is *N/A*.

CPU to PCI Write Buffer

When enabled, this option increases the efficiency of the PCI bus to and speed up the execution in the processor. By default, this field is set to *Enabled*.

PCI Dynamic Bursting

When enabled, this option combines several PCI cycles into one. By default, this field is set to *Disabled*.

PCI Master 0 WS Write

When enabled, this option increases the write cycle speed.

PCI Delay Transaction

When enabled, this option delays PCI data transaction. By default, this field is set to *Enabled*.

PCI#2 Access #1 Retry

This item enables PC#2 Access #1 attempts. By default, this field is set to *Disabled*.

AGP Master 1 WS Write

When enabled, writes to the AGP bus are executed with 1 wait states. By default, this field is set to *Enabled*.

AGP Master 1 WS Read

When enabled, reads to the AGP bus are executed with 1 wait states. By default, this field is set to *Enabled*.

PCI IRQ Activated by

This field allows you to select the method by which the PCI bus recognizes that an IRQ service is being requested by a device. The default value is *Level*.

Assign IRQ for USB/VGA

These fields allow you to enable or disable the IRQ for USB and VGA. By default, these fields are enabled.

6.8 Load BIOS Defaults

This option allows you to load the troubleshooting default values permanently stored in the BIOS ROM. These default settings are non-optimal and disable all high-performance features.

ROM PCI/ISA BIOS CMOS SETUP UTILITY AWARD SOFTWARE, INC.	
STANDARD CMOS SETUP	CPU SPEED SETTING
BIOS FEATURES SETUP	INTEGRATED PERIPHERALS
CHIPSET FEATURES SETUP	SUPERVISOR PASSWORD
POWER MANAGE	LOAD BIOS DEF
PNP/PCI CONF	LOAD SETUP DEF
LOAD BIOS DEF	LOAD SETUP DEF
ESC : Quit	↑ ↓ → ← : Select Item
F10 : Save & Exit Setup	(Shift) F2 : Change Color
Load BIOS Defaults except Standard CMOS Setup	

To load BIOS defaults value to CMOS SRAM, enter “Y”. If not, enter “N”.

6.9 Load Setup Defaults

This option allows you to load the default values to your system configuration. These default settings are optimal and enable all high performance features.

ROM PCI/ISA BIOS CMOS SETUP UTILITY AWARD SOFTWARE, INC.	
STANDARD CMOS SETUP	CPU SPEED SETTING
BIOS FEATURES SETUP	INTEGRATED PERIPHERALS
CHIPSET FEATURES SETUP	SUPERVISOR PASSWORD
POWER MANAGE	LOAD BIOS DEF
PNP/PCI CONF	LOAD SETUP DEF
LOAD BIOS DEF	LOAD SETUP DEF
ESC : Quit	↑ ↓ → ← : Select Item
F10 : Save & Exit Setup	(Shift) F2 : Change Color
Load BIOS Defaults except Standard CMOS Setup	

To load SETUP defaults value to CMOS SRAM, enter “Y”. If not, enter “N”.

6.10 CPU Speed Setting

This setup option sets the CPU speed and parameters of the CPU temperature and fan speeds.

ROM PCI/ISA BIOS
CPU Speed Setting
AWARD SOFTWARE INC.

CPU Speed : 33MHz (66x5)	
CPU Warning Temperature	: 75°C/167°F
Current System Temp.	: 63°C/145°F
Current CPU Tem.	: 43°C/109°F
Current CPU Fan Speed	: 4383 RPM
Current Chassis Fan Speed	: 3901 RPM
Current VGA Fan Speed	: 4192 RPM
Vcore	: 2.01V +3.3V : 3.39V
+5 V	: 4.99V +12 V : 11.97V
-12 V	: -12.19V
CPU Fan Monitor	: Disabled
Chassis Fan Monitor	: Disabled
VGA Fan Monitor	: Disabled
Shutdown Temperature	: 95°C/203°F
ESC : Quit ↑ ↓ ← : Select Item F1 : Help PU/PD/+/- : Modify F5 : Old Values (Shift) F2 : Color F6 : Load BIOS Defaults F7 : Load Setup Defaults	

CPU Speed, CPU Clock Multiplier, CPU/PCI Clock Select

The motherboard allows users to set the CPU speed through the BIOS. The parameters in setting the CPU speed include *CPU Clock Multiplier* (X3, X3.5, X4, X4.5, X5, X5.5, X6.5, X7, X7.5, X8) and *CPU/PCI Clock Select* (66/33MHz, 75/37MHz, 83/41MHz or 100/33MHz, 103/34MHz, 105/35MHz, 110/36MHz, 112/37MHz, 115/38MHz, 120/40MHz, 124/41MHz, 124/31MHz, 133/44MHz, 133/33MHz, 140/35MHz, 150/37MHz). The parameters only appear when CPU Speed is set to *Manual*.

NOTE: Processors with locked/fixed frequencies will have a fixed CPU Clock Multiplier and will not allow changes to its value.

Aside from the *Manual* option, CPU Speed can be set to 200MHz (66x3), 233MHz (66x3.5), 266MHz (66x4), 300MHz (66x4.5), 333MHz (66x5), 366MHz (66x5.5), 400MHz (66x6), and 433MHz (66x6.5). Press the ↑ and ↓ keys to change the CPU speed or press the PageUp or PageDown key to see the selections for CPU Clock Multiplier and CPU Clock.

NOTE: *Overclocking could cause the system not to boot. When this happens, turn off the computer by pressing the power button and turn it on again by pressing the **Insert** key and the power button simultaneously. Then press the **Delete** key to enter BIOS Setup and configure the CPU speed.*

CPU Warning Temperature

This field sets the threshold temperature at which an alert is sounded through the system's speaker. The onboard thermal sensor monitors the CPU temperature to prevent the CPU from overheating.

Current System / CPU Temp.

These read-only fields reflect the functions of the hardware thermal sensor that monitors the chip blocks and system temperatures to ensure the system is stable.

Current CPU /Chassis / VGA Fan Speed

These read-only fields show the current speeds in RPM (revolution per minute) for the CPU fan and chassis fan as monitored by the hardware monitoring IC.

Vcore / +5V / +3.3V / -12V / +12V

These read-only fields show the current voltages in the voltage regulators and power supply as monitored by the hardware monitoring IC.

CPU /Chassis / VGA Fan Monitor

These fields disable the monitoring of the CPU fan, chassis fan, and VGA fan or set the minimum RPM as *3,000RPM*, *3,500RPM*, and *4,000RPM*. When the actual RPM falls below the set value, the system's speaker will sound an alarm. By default, these fields are set to **Disabled**.

Shutdown Temperature

This field allows you to set the temperature at which the system automatically shuts down once it is reached, in order to avoid damage to system components.

6.11 Integrated Peripherals

This option sets your hard disk configuration, mode and port.

ROM PCI/ISA BIOS
INTEGRATED PERIPHERALS
AWARD SOFTWARE INC.

IDE HDD Block Mode	: Enabled	Onboard FDC Controller	: Enabled
IDE Primary Master PIO	: Auto	Onboard Serial Port 1	: 3F8/IRQ4
IDE Primary Slave PIO	: Auto	Onboard Serial Port 2	: 2F8/IRQ3
IDE Secondary Master PIO	: Auto	UART Mode Select	: Normal
IDE Secondary Slave PIO	: Auto		
IDE Primary Master UDMA	: Auto		
IDE Primary Slave UDMA	: Auto	Onboard Parallel Port	: 378/IRQ7
IDE Secondary Master UDMA	: Auto	Parallel Port Mode	: SPP
IDE Secondary Slave UDMA	: Auto		
On-Chip Primary PCI IDE	: Enabled		
On-Chip Secondary PCI IDE	: Enabled		
USB Keyboard Support	: Disabled		
Init AGP Display First	: AGP		
POWER ON Function	: Button Only		
		ESC : Quit	↑ ↓ ← : Select Item
		F1 : Help	PU/PD/+/- : Modify
		F5 : Old Values	(Shift) F2 : Color
		F6 : Load BIOS Defaults	
		F7 : Load Setup Defaults	

(For Intel 82440BX/ZX/GX)

ROM PCI/ISA BIOS
INTEGRATED PERIPHERALS
AWARD SOFTWARE INC.

On-Chip IDE Channel 0	: Enabled	Onboard FDC Controller	: Enabled
On-Chip IDE Channel 1	: Enabled	Onboard Serial Port 1	: 3F8/IRQ4
IDE Prefetch Mode	: Disabled	Onboard Serial Port 2	: 2F8/IRQ3
IDE HDD Block Mode	: Enabled	UART Mode Select	: Normal
Primary Master PIO	: Auto		
Primary Slave PIO	: Auto		
Secondary Master PIO	: Auto	Onboard Parallel Port	: 378/IRQ7
Secondary Slave PIO	: Auto	Parallel Port Mode	: SPP
Primary Master UDMA	: Auto		
Primary Slave UDMA	: Auto		
Secondary Master UDMA	: Auto		
Secondary Slave UDMA	: Auto		
Init AGP Display First	: AGP		
POWER ON Function	: Button Only		
		ESC : Quit	↑ ↓ ← : Select Item
		F1 : Help	PU/PD/+/- : Modify
		F5 : Old Values	(Shift) F2 : Color
		F6 : Load BIOS Defaults	
		F7 : Load Setup Defaults	

(For VIA 82C693)

IDE HDD Block Mode

This field allows your hard disk controller to use the fast block mode to transfer data to and from your hard disk drive.

IDE Primary/Secondary Master/Slave PIO

These fields allow your system hard disk controller to work faster. Rather than have the BIOS issue a series of commands that transfer to or from the disk drive, PIO (Programmed Input/Output) allows the BIOS to communicate with the controller and CPU directly. The system supports five modes, numbered from 0 (default) to 4, which primarily differ in timing. When Auto is selected, the BIOS will select the best available mode.

IDE Primary/Secondary Master/Slave UDMA

These fields allow your system to improve disk I/O throughput to 33Mb/sec with the Ultra DMA/33 feature. The options are *Auto* and *Disabled*.

On-Chip Primary/Secondary PCI IDE

The integrated peripheral controller contains an IDE interface with support for two IDE channels. Select *Enabled* to activate each channel separately.

OnChip IDE Channel0/1

The integrated peripheral controller contains an IDE interface with support for two IDE channels. Select *Enabled* to activate each channel separately.

USB Keyboard Support

Select *Enabled* if your system contains a Universal Serial Bus (USB) controller and you have a USB keyboard.

Init AGP Display First

This field allows the system to initialize first the VGA card in the AGP slot on the motherboard when system is turned on.

Power On Function

The default for this field is *Button Only*. When set to *KB Power ON Password*, the user is allowed to set a password with a maximum of 5 characters. The system recognizes the size (lowercase/uppercase) of the characters entered. The third option is *Hot Key Power ON*. The keys Ctrl-F1 to Ctrl-F12 can be set to power on the system.

Onboard FDC Controller

Select *Enabled* if your system has a floppy disk controller (FDC) installed on the system board and you wish to use it. If you install an add-in FDC or the system has no floppy drive, select *Disabled* in this field. This option allows you to select the onboard FDD port.

Onboard Serial/Parallel Port

These fields allow you to select the onboard serial and parallel ports and their addresses. The default values for these ports are:

Serial Port 1	3F8/IRQ4
Serial Port 2	2F8/IRQ3
Parallel Port	378H/IRQ7

UART Mode Select

This field determines the UART mode in your computer. The settings are *Normal*, *IrDA* and *ASKIR*. The default value is *Normal*.

Parallel Port Mode

This field allows you to determine parallel port mode function.

SPP	Normal Printer Port
EPP	Enhanced Parallel Port
ECP	Extended Capabilities Port

6.12 Supervisor / User Password

These two options set the system password. Supervisor Password sets a password that will be used to protect the system and Setup utility. User Password sets a password that will be used exclusively on the system. To specify a password, highlight the type you want and press <Enter>. The Enter Password: message prompts on the screen. Type the password, up to eight characters in length, and press <Enter>. The system confirms your password by asking you to type it again. After setting a password, the screen automatically returns to the main screen.

To disable a password, just press the <Enter> key when you are prompted to enter the password. A message will confirm the password to be disabled. Once the password is disabled, the system will boot and you can enter Setup freely.

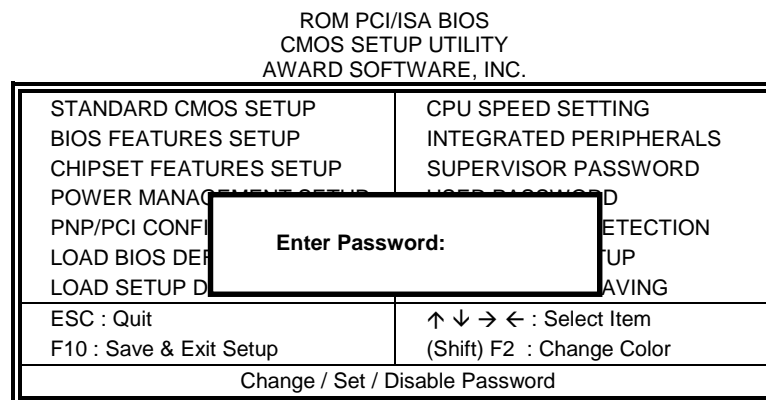

6.13 IDE HDD Auto Detection

This option detects the parameters of an IDE hard disk drive, and automatically enters them into the Standard CMOS Setup screen.

ROM PCI/ISA BIOS
STANDARD CMOS SETUP
AWARD SOFTWARE, INC.

HARD DISKS	TYPE	SIZE	CYLS	HEAD	PRECOMP	LANDZ	SECTOR	MODE
Primary Master:								
Select Primary Master Option (N=SKIP) : N								
OPTIONS	TYPE	SIZE	CYLS	HEAD	PRECOMP	LANDZ	SECTOR	MODE
1 (Y)	0	0	0	0	0	0	0	NORMAL
NOTE: Some OSes (like SCO-UNIX) must use "NORMAL" for installation								
ESC: SKIP								

Up to four IDE drives can be detected, with parameters for each appearing in sequence inside a box. To accept the displayed entries, press the "Y" key to skip to the next drive, press the "N" key. If you accept the values, the parameters will appear listed beside the drive letter on the screen.

6.14 Save & Exit Setup

This option allows you to determine whether to accept the modifications or not. If you type “Y”, you will quit the setup utility and save all changes into the CMOS memory. If you type “N”, you will return to Setup utility.

ROM PCI/ISA BIOS
CMOS SETUP UTILITY
AWARD SOFTWARE, INC.

STANDARD CMOS SETUP	CPU SPEED SETTING
BIOS FEATURES SETUP	INTEGRATED PERIPHERALS
CHIPSET FEATURES SETUP	SUPERVISOR PASSWORD
POWER MANAGE	D
PNP/PCI CONF	DETECTION
LOAD BIOS DEF	UP
LOAD SETUP DEFAULTS	EXIT WITHOUT SAVING
ESC : Quit	↑ ↓ → ← : Select Item
F10 : Save & Exit Setup	(Shift) F2 : Change Color
Save Data to CMOS & Exit Setup	

6.15 Exit Without Saving

Select this option to exit the Setup utility without saving the changes you have made in this session. Typing “Y” will quit the Setup utility without saving the modifications. Typing “N” will return you to Setup utility.

ROM PCI/ISA BIOS
CMOS SETUP UTILITY
AWARD SOFTWARE, INC.

STANDARD CMOS SETUP	CPU SPEED SETTING
BIOS FEATURES SETUP	INTEGRATED PERIPHERALS
CHIPSET FEATURES SETUP	SUPERVISOR PASSWORD
POWER MANAGE	D
PNP/PCI CONF	DETECTION
LOAD BIOS DEF	UP
LOAD SETUP DEFAULTS	EXIT WITHOUT SAVING
ESC : Quit	↑ ↓ → ← : Select Item
F10 : Save & Exit Setup	(Shift) F2 : Change Color
Abandon all Data & Exit Setup	

Chapter 7 Audio Driver Installation Guide

This chapter describe the audio driver installation procedure for the onboard audio chipset The onboard audio consists of the Creative ES1373 Chip + AC97. With a PCI Bus Mastering interface with DOS compatibility, it supports 32 voices wavetable, surround sound, 3D audio, and audio effects such as reverb and chorus. Creative ES1373 uses single, shareable PCI interrupt and is PC97 compliant.

For normal operations and to maximize the audio functions of the motherboard, follow the audio driver installation procedure below.

Installing The Audio Drivers For Windows 95

1. Under Windows 95, click START => Setting => Control Panel.

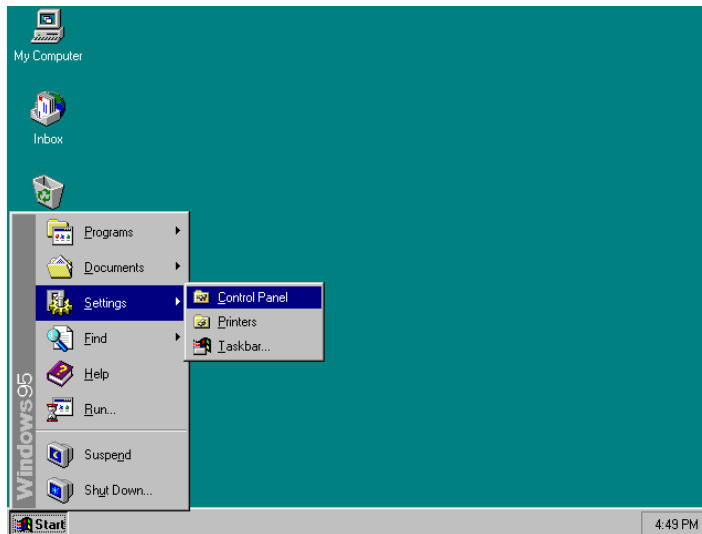

2. Under the Control Panel window, click the System icon.

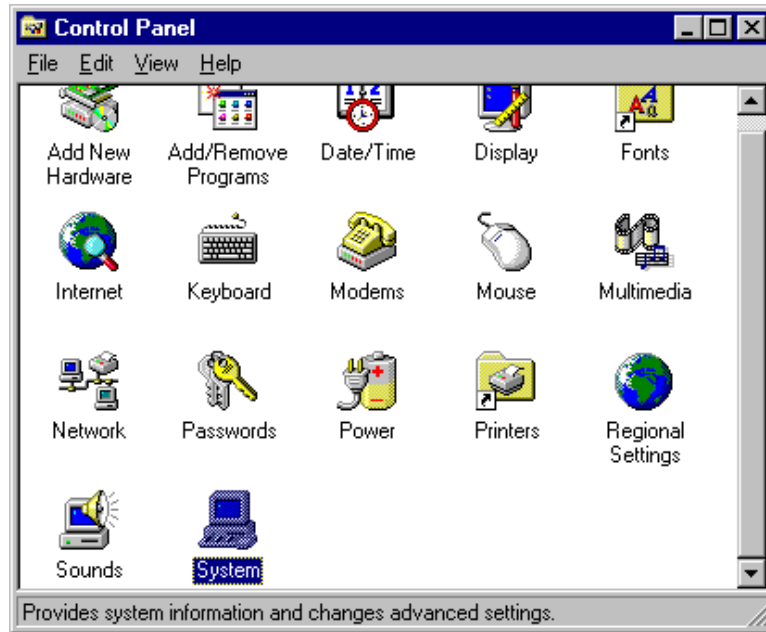

3. Click Device Manager.

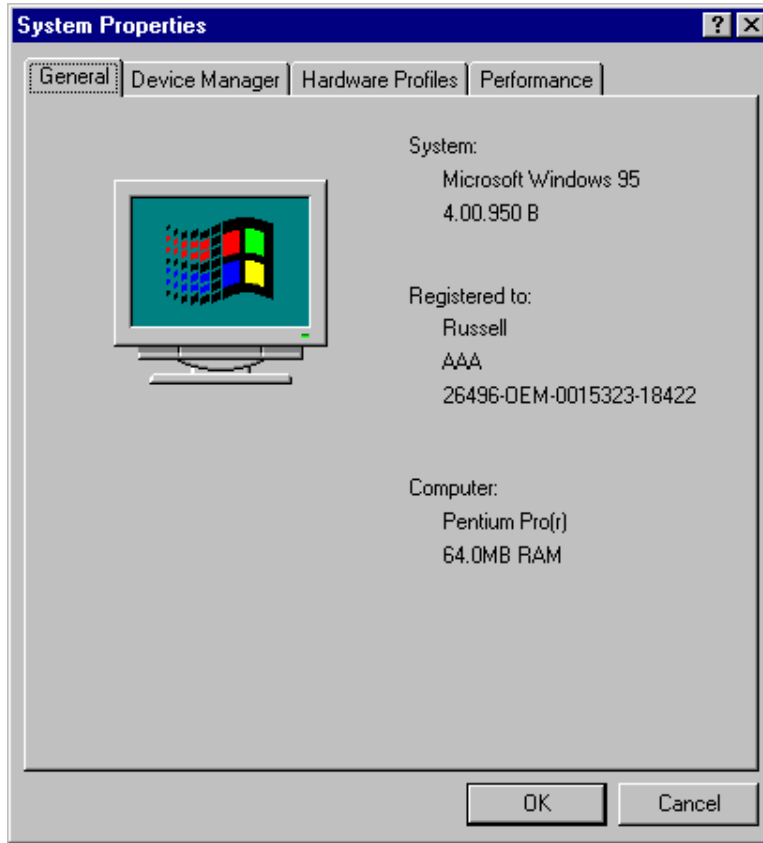

4. Click Other Device, then select PCI Multimedia Audio Device and click the Remove icon.

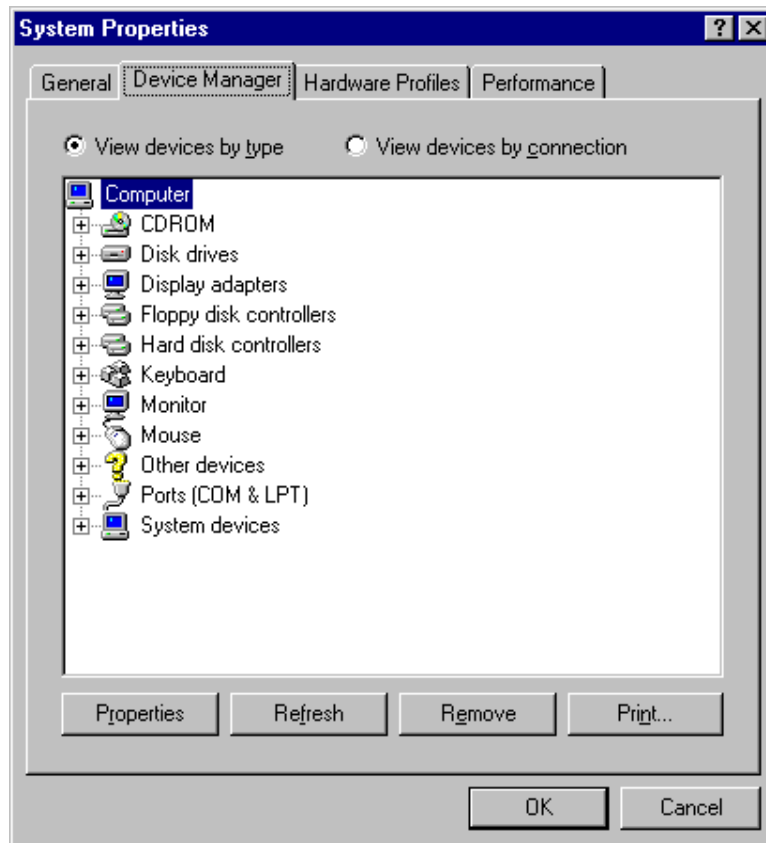

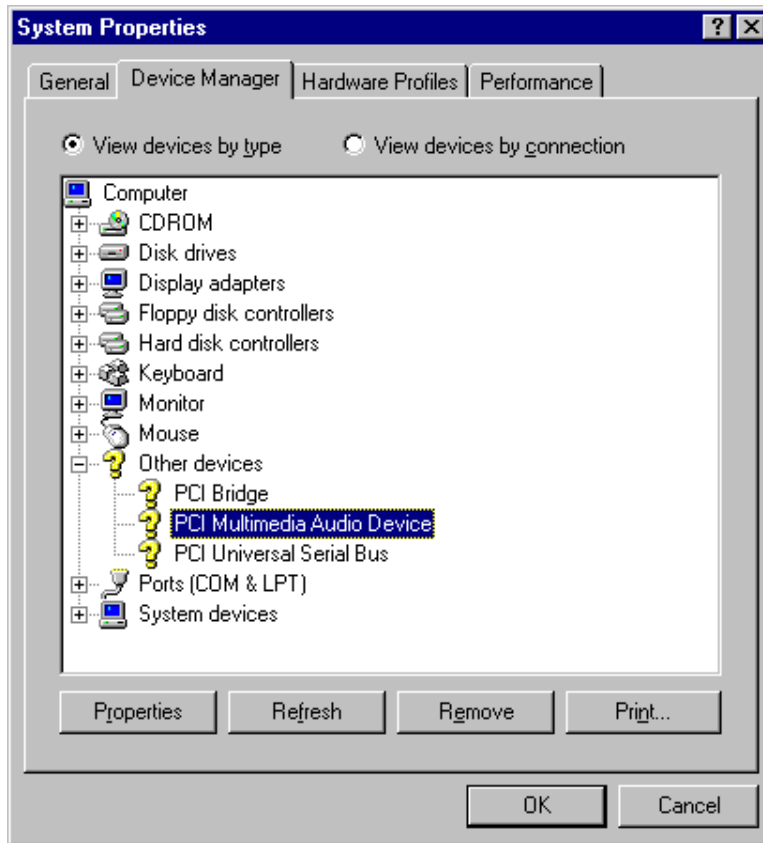

Confirm the remove command by clicking OK.

6. Click Close.

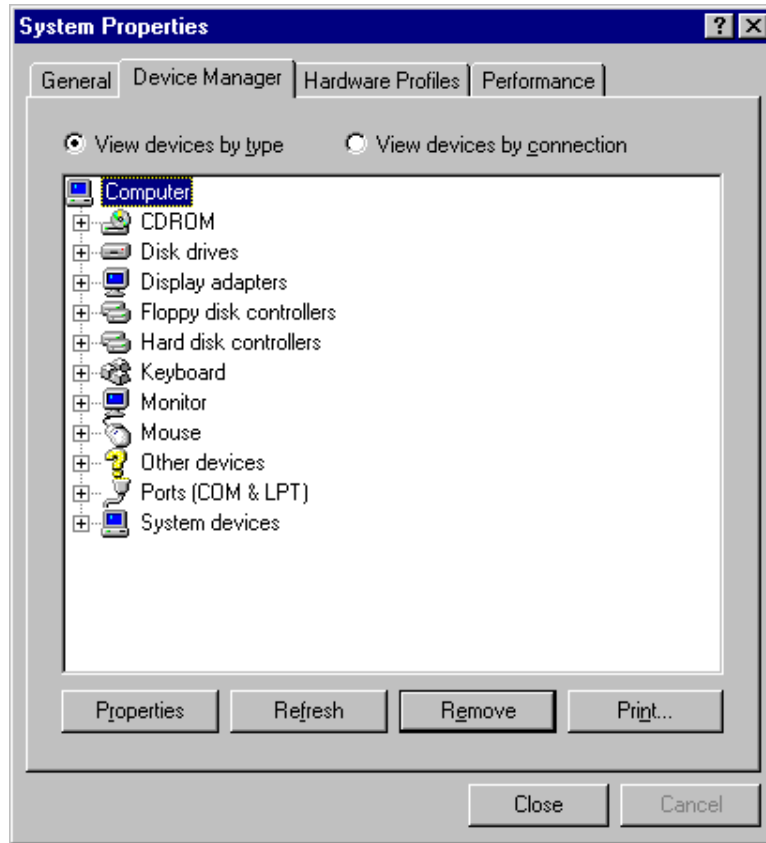

7. Insert the CD that comes with your motherboard into your CD-ROM drive. The following screen will appear.



Now click Sound.

8. Double click Creative Labs 1373.

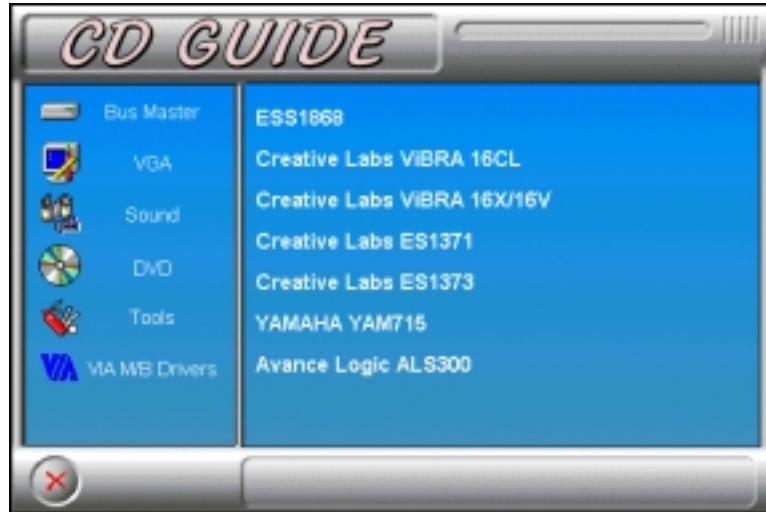

10. Follow the procedure in each screen until you arrive the Setup Option screen as shown below, then select Full Installation.

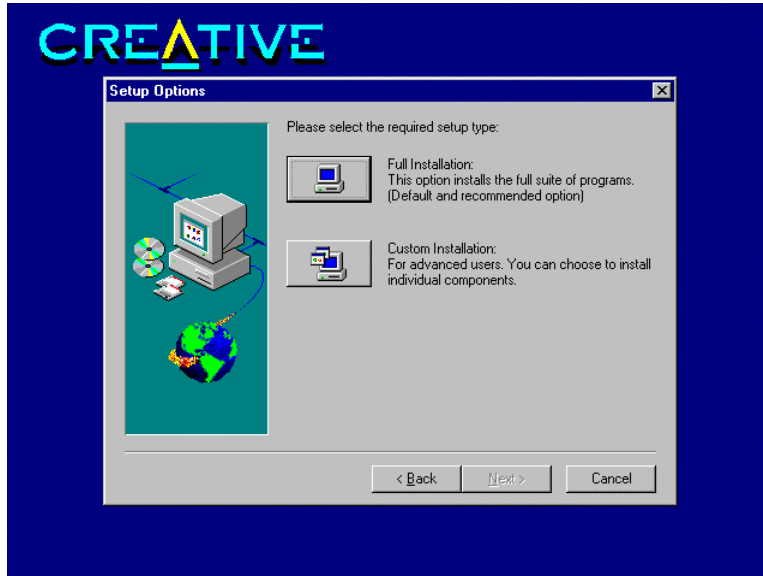

11. Proceed with Setup to install the Windows 98 Drivers, Legacy DOS Drivers into your system.
12. After installation, the system will ask you to restart your computer for the changes to take effect.

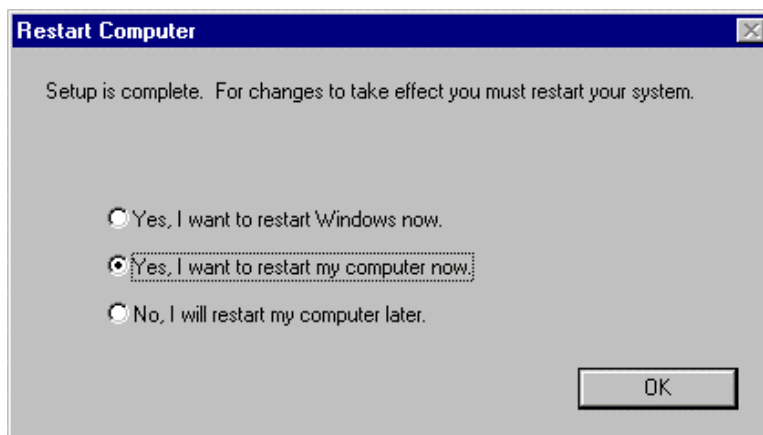

This page was intentionally left blank.

Chapter 8 System Monitor Utility User's Guide

This chapter introduces System Monitor Utility that comes with the motherboard in conjunction with the onboard hardware monitoring IC. The sections below give the functions of the utility.

System Monitor is a software utility that oversees the general performance of systems, covering areas like system temperature, system voltage, CPU and system fan rotational speeds. If conditions become adverse, that is, when voltages are erratic or CPU temperature exceeds the safe limits, an alarm will be sounded; thereby preventing system crashing and ensuring overall stability.

When System Monitor is initiated, the icon below appears in the task bar in the Windows environment.



The following screen appears upon clicking on the System Monitor icon.



Clicking on the 'X' on the upper right corner would show you the latest company information or on any icon on the left side to display further information.

The following section describes the different functions of System Monitor.

1. Computer - displays the operating working system version and processor type.



2. Memory - displays the current memory usage status.

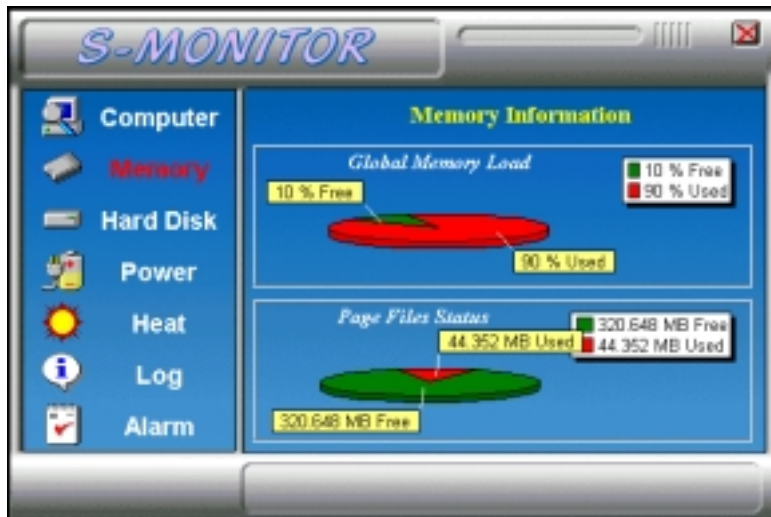

3. Hard Disk - displays the supported disk formats and disk space.

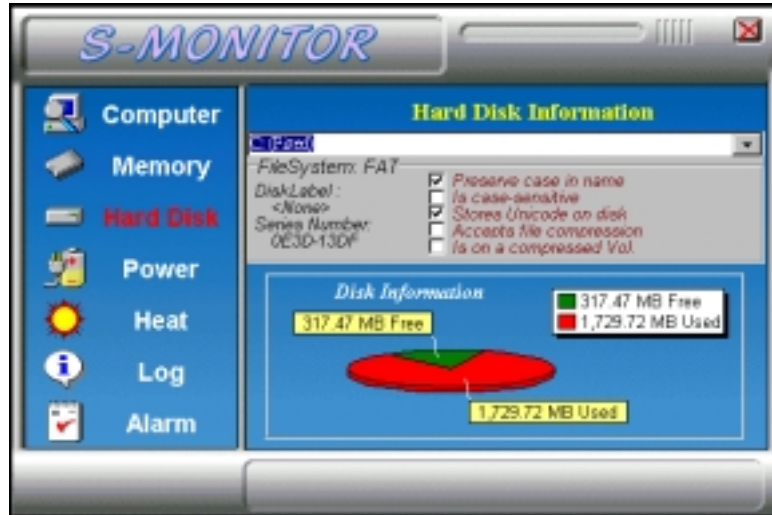

4. Heat - displays the current rotational speed of CPU and Chassis fans, as well as the system and CPU temperatures.

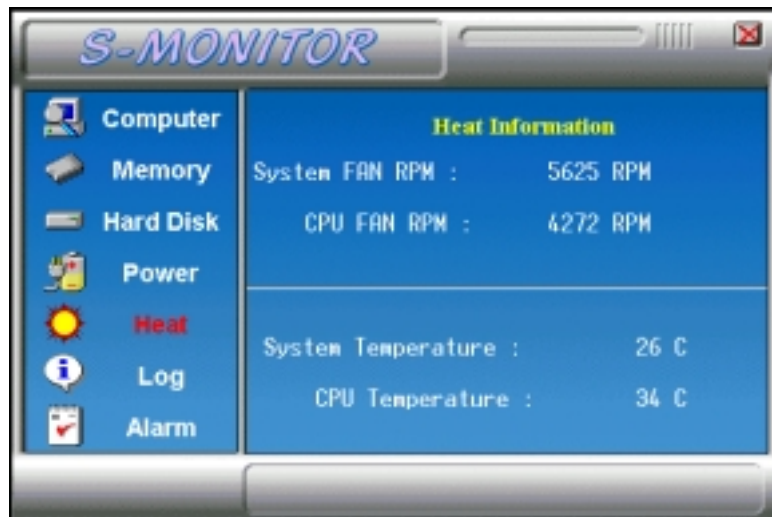

5. Power - displays the current voltage status.

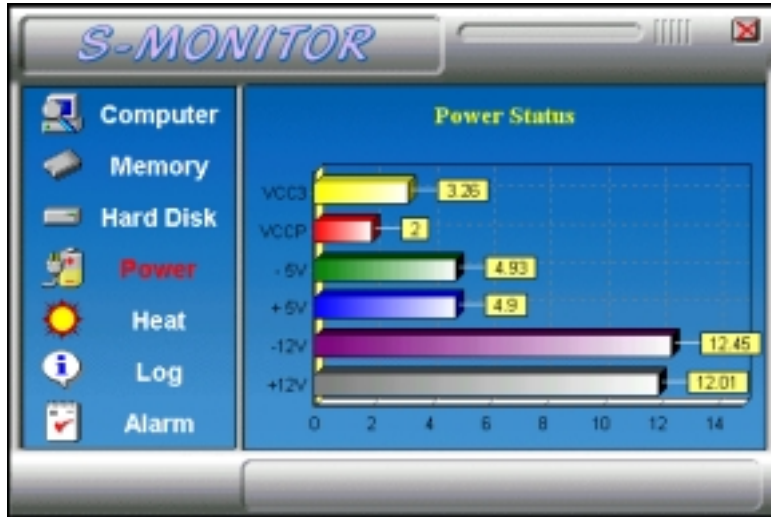

NOTE: For Pentium II processors, System Monitor detects the VCC3 and VCCP values. For Pentium-level processors, System Monitor detects the VCORE and VIO values.

6. Log - displays errors occurring after System Monitor is started.



7. Alarm - sets the values at which an alarm is sounded.



Voltage : the acceptable voltage range between the "MAX" and "MIN" value.

Temperature : temperature threshold.

Fan Rotation Speed : the minimum rotation speed.

NOTE: Intel has defined a margin of difference for the voltages as below:

12 Volts - 10% (10.8V ~ 13.2V)

5 Volts - 5% (4.75 ~ 5.25%)

Vio - 5% (Vio for P54C CPU is 3.5V. Vio for P55C is 3.3V.)

Vcore- 5%

** VCC3 / VIO and VCCP / VCORE values vary according to the processors used. Please contact the CPU manufacturer for further information.*

This page was intentionally left blank.

Chapter 9 LANDesk User's Guide

This chapter gives a brief introduction to the optional LANDesk® Client Manager (LDCM) utility, as well as the installation procedures.

The following items are covered in this chapter:

9.1 Introduction	81
9.2 Installation	82
9.2.1 Installing the Local Version of LDCM	
9.2.2 Installing the Administrative Version of LDCM	

LANDesk is a registered trademark of Intel Corporation.

9.1 Introduction

LANdesk Client Manager (LDCM 3.1) provides the capability for managing components (network interface cards, memory, printers, software applications, etc.) within a PC system. It uses the Desktop Management Interface (DMI) standard established by the Desktop Management Task Force (DMTF). Manageable components can be viewed, monitored, and administrated across multiple platforms, either locally or remotely on a network.

The LDCM package has been implemented in two different ways: a user (client/local) version and an administrative version (Remote Companion). The user version provides the ability to only manage the local PC. The administrative version allows a network administrator to manage the local PC and other PC nodes on the network. This means that the administrative version has the ability to gather information about remote PCs, as well as remotely controlling the PCs. The remote access is based upon granted rights by the managed client.

LDCM provides the user with self-help diagnostics, including a PC health meter, local alerting of potential problems, and hardware and software inventory. Automatic polling and alerting of memory and hardware conditions and predictive failure mechanisms minimize downtime and increase effective troubleshooting. LDCM can take periodic "snapshots" of critical configuration files for easy change management and restoration when needed.

To use LDCM, your computer must meet the following requirements:

- Operating System: Windows 95, Windows NT 3.51, or Windows NT4.0
- Memory: about 200KB
- Disk Storage Space: 3-5MB
- Hardware System: a DMI BIOS is required for full LDCM functionality

For network computers, the following requirements also apply:

- Protocols: IPX or IP (WinSock-enabled) communication protocol loaded on the client
- Hardware Interfaces: a network card for communication on the network

9.2 Installation

The optional LANDesk utility that comes with the CPU card runs in Windows NT or Windows 95 operating system.

Upon entering the Windows NT 4.0 or Windows 95 environment, insert the CD. Windows will autorun the installation program and show the following screen.

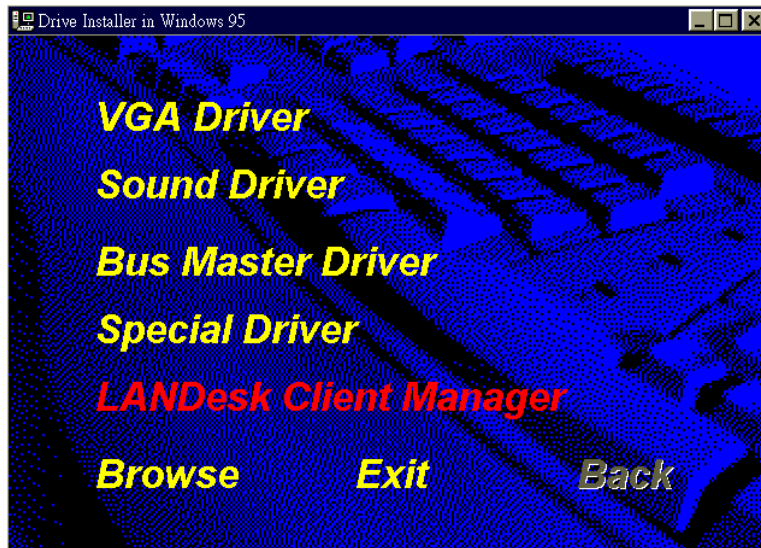

NOTE: During Setup, you will be asked to install Internet Explorer 3.02 in order to continue, or else Setup will be aborted. LDCM supports various languages and will default to English if it is unable to load 'language.dl'..

9.2.1 Installing the Local Version of LDCM

Double Click on 'LANdesk Client Manager' in the initial screen and the following screen will appear. Double click on the local version of LANdesk Client Manager.



When the Welcome screen appears, click on "Next" to continue with Setup.

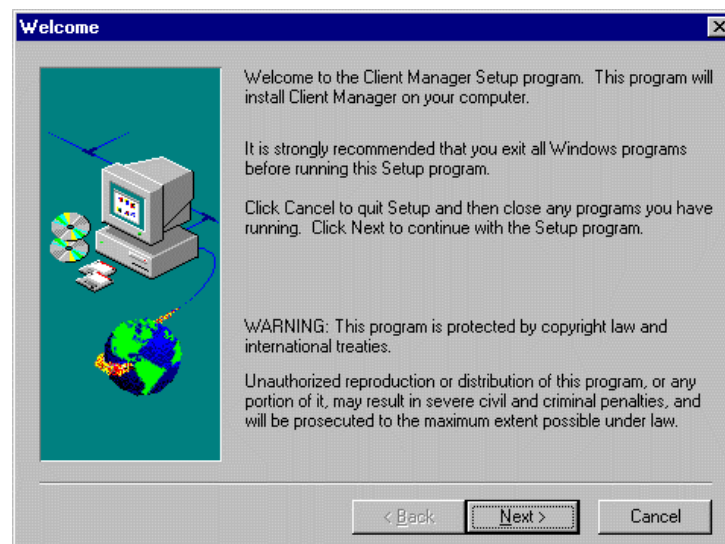

Choose the directory location where Setup will install LANdesk Client Manager. Click "Browse" if you want to change the directory suggested. Otherwise, click "Next" to start installing LDCM.

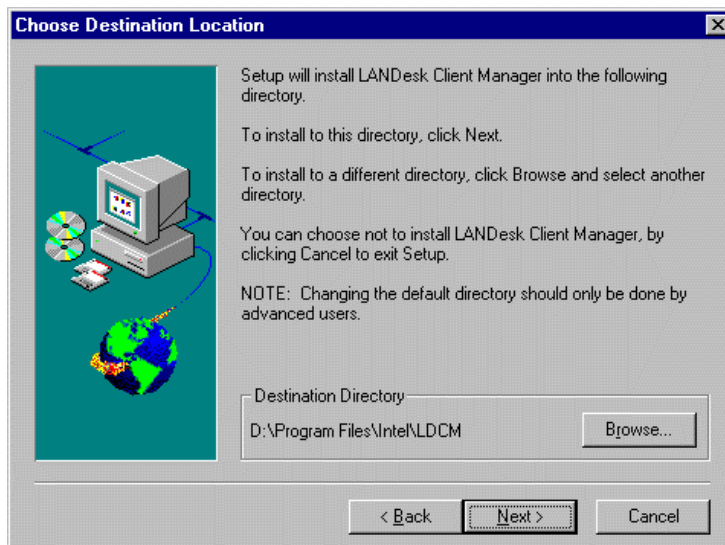

When Setup is finished, changes will have been made to the file AUTOEXEC.BAT. Restart your computer for the changes to take effect.

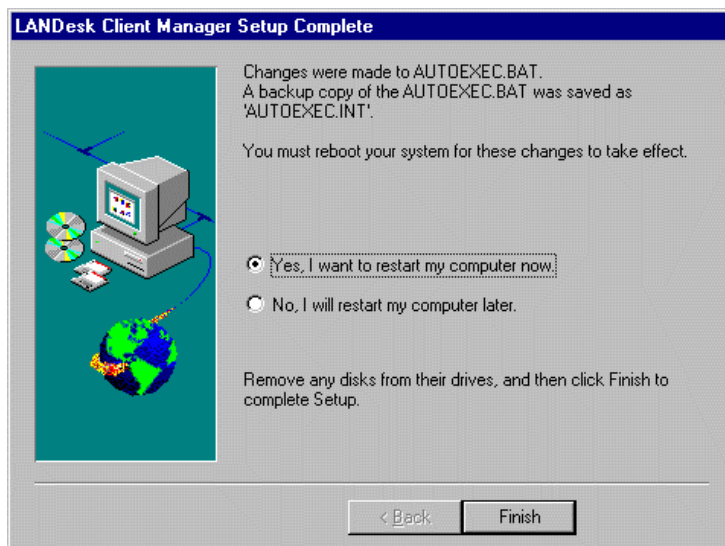

9.2.2 Installing the Administrative Version of LDCM

After double clicking on 'LANdesk Client Manager' in the initial screen, select the administrative version of the LDCM and the Welcome screen below will appear. Click on "Next" to continue.

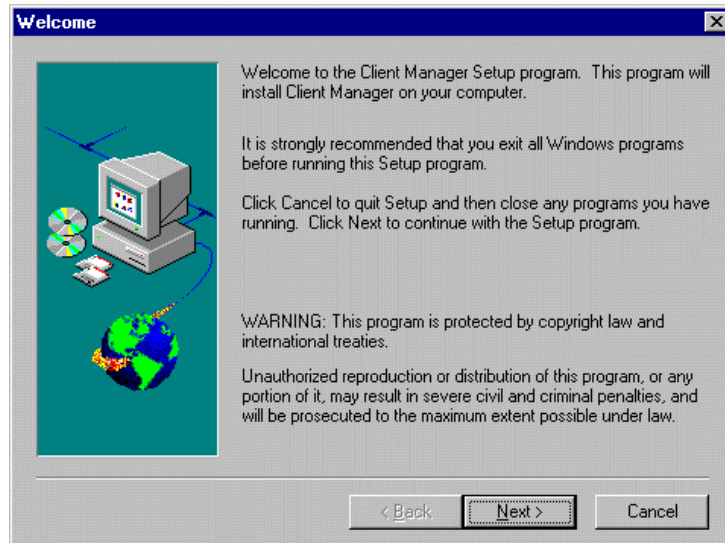

The screen below allows you to install the documentation in Adobe Acrobat format and the Adobe Acrobat Reader software. Select the options you need and click on "Next" to start the installation.

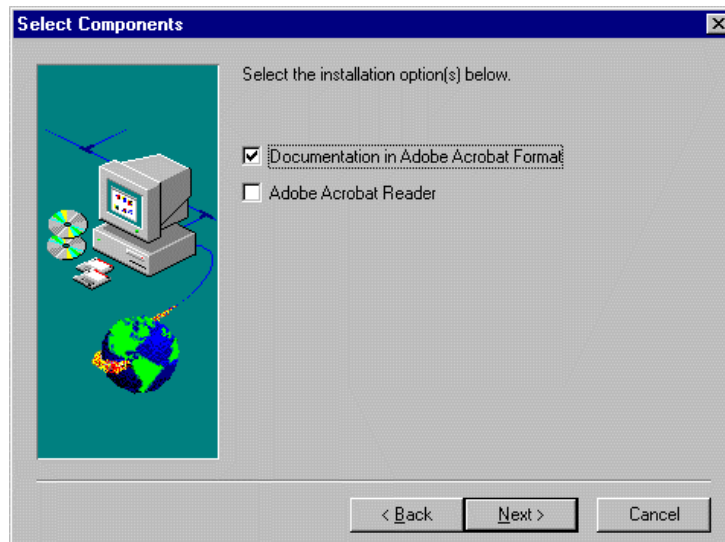

After LANdesk Client Manager Setup is complete, restart your computer to be able to use the LANdesk Client Manager.

