

PT-5V3T / 5VMT

SYSTEM BOARD

(VER. 1.x)

OPERATION MANUAL

TABLE OF CONTENTS

Chapter & Section	Page
1. INTRODUCTION	1-1
1.1 SYSTEM OVERVIEW	1-1
1.2 SYSTEM BOARD LAYOUT	1-2
2. FEATURES	2-1
2.1 MAINBOARD SPECIFICATIONS	2-1
2.2 ADVANCED CONFIGURATION POWER INTERFACE (ACPI).....	2-4
2.3 POWER OFF THE PC SYSTEM.....	2-5
3. HARDWARE SETUP	3-1
3.1 UNPACKING.....	3-1
3.2 HARDWARE CONFIGURATION.....	3-1
3.2.1 CONNECTORS	3-2
3.2.2 JUMPERS.....	3-8
3.3 INSTALLING A CPU ONTO THE ZIF SOCKET	3-20
3.4 INSTALLATION OF CPU COOLING FAN.....	3-22
3.5 UPGRADE THE SYSTEM MEMORY	3-23
3.5.1 Installing a SIMM module.....	3-23
3.5.2 Install the DIMM Module	3-24
3.5.3 Suggested Memory Modules.....	3-25
4. AWARD BIOS SETUP	4-1
4.1 GETTING STARTED.....	4-1
4.2 MAIN MENU	4-2
4.3 CONTROL KEYS	4-2
4.4 STANDARD CMOS SETUP.....	4-3
4.5 BIOS FEATURES SETUP	4-5
4.6 CHIPSET FEATURES SETUP	4-7
4.7 POWER MANAGEMENT SETUP.....	4-8
4.8 PNP/PCI CONFIGURATION	4-9
4.9 INTEGRATED PERIPHERALS.....	4-12
4.10 LOAD SETUP DEFAULTS.....	4-13
4.11 SUPERVISOR PASSWORD / USER PASSWORD	4-13
4.12 IDE HDD AUTO DETECTION.....	4-14
4.13 HDD LOW LEVEL FORMAT	4-14
4.14 SAVE &EXIT SETUP.....	4-15
4.15 EXIT WITHOUT SAVING.....	4-15

TRADEMARKS

All trademarks used in this manual are the property of their respective owners.

NOTE

The “LOAD SETUP DEFAULTS” function loads the default settings directly from BIOS default table, these default settings are the best-case values that will optimize the system performance and increase the system stability. This strongly recommended when you first receive this system board, or the system CMOS data is corrupted.

Move the selection bar to “LOAD SETUP DEFAULTS” and then press the “ENTER” key and then the SETUP default values will be loaded into the system. (Please refers to the Chapter 4 AWARD BIOS SETUP procedures in this manual.)

NOTICE

Information presented in this manual has been carefully checked for reliability; however, no responsibility is assumed for inaccuracies. The information contained in this manual is subject to change without prior notice.

1. INTRODUCTION

1.1 SYSTEM OVERVIEW

The □PT-5V3T / 5VMT□ is a AT form-factor PCI Local Bus Pentium system mainboard with the updated AGP technology designed onboard. □PT-5V3T / 5VMT□ will either uses the VIA VP3 or VIA MVP3 chipset on the board. Different chipset will give different performance to your PC system. Basically, the features between VP3 and MVP3 are almost identical, except the system clock of MVP3 is 100MHz and VP3 has the 66.6MHz system clock.

PT-5V3T / 5VMT is designed for the high performance Pentium or other equivalent processors for high-end application and it is a true GREEN-PC computer system. The product name will be PT-5V3T when the VP3 chipset is installed onboard. If the MVP3 chipset is populated on the board, the product name will become PT-5VMT.

This system board supports the Peripheral Component Interconnect (PCI) Local Bus standard (PCI Specification Rev. 2.1 compliant). It not only breaks through the I/O bottlenecks if the traditional ISA mainboard, but also provides the performance needs for networking and multi-user environments.

The mainboard has built-in two channels PIO and Bus Master Enhanced PCI IDE port, one Floppy Disk control port, two high speed Serial ports (UARTs), one multi-mode Parallel port, one PS/2 keyboard port, one PS/2 mouse port, one IR port, two USB ports, and supports PC97 specification.

The Accelerated Graphic Port (A.G.P.) on the board is designed for the updated AGP 3D video display card. Unlike the traditional PCI-based display cards. AGP technology provides lightning data throughput to fully facilitate the 3Dimensional and multimedia graphic display. The data transfer rate on the AGP port can be as fast as 133MHz and it is much faster than the traditional 33MHz PCI VGA cards.

The AGP is a new video display technology and it requires the device driver or new operating system to enable the accelerated graphic feature. Windows® 98 will supports AGP directly, but Windows® 95 still needs the appropriate device drivers to enable the AGP feature. Please don't worry about the device driver, you can always find the device driver included in the AGP card.

1.2 SYSTEM BOARD LAYOUT

Explanation : All connectors, jumpers and components which are marked by a black point on the corner means the pin-1 side of the connector, jumper and component.

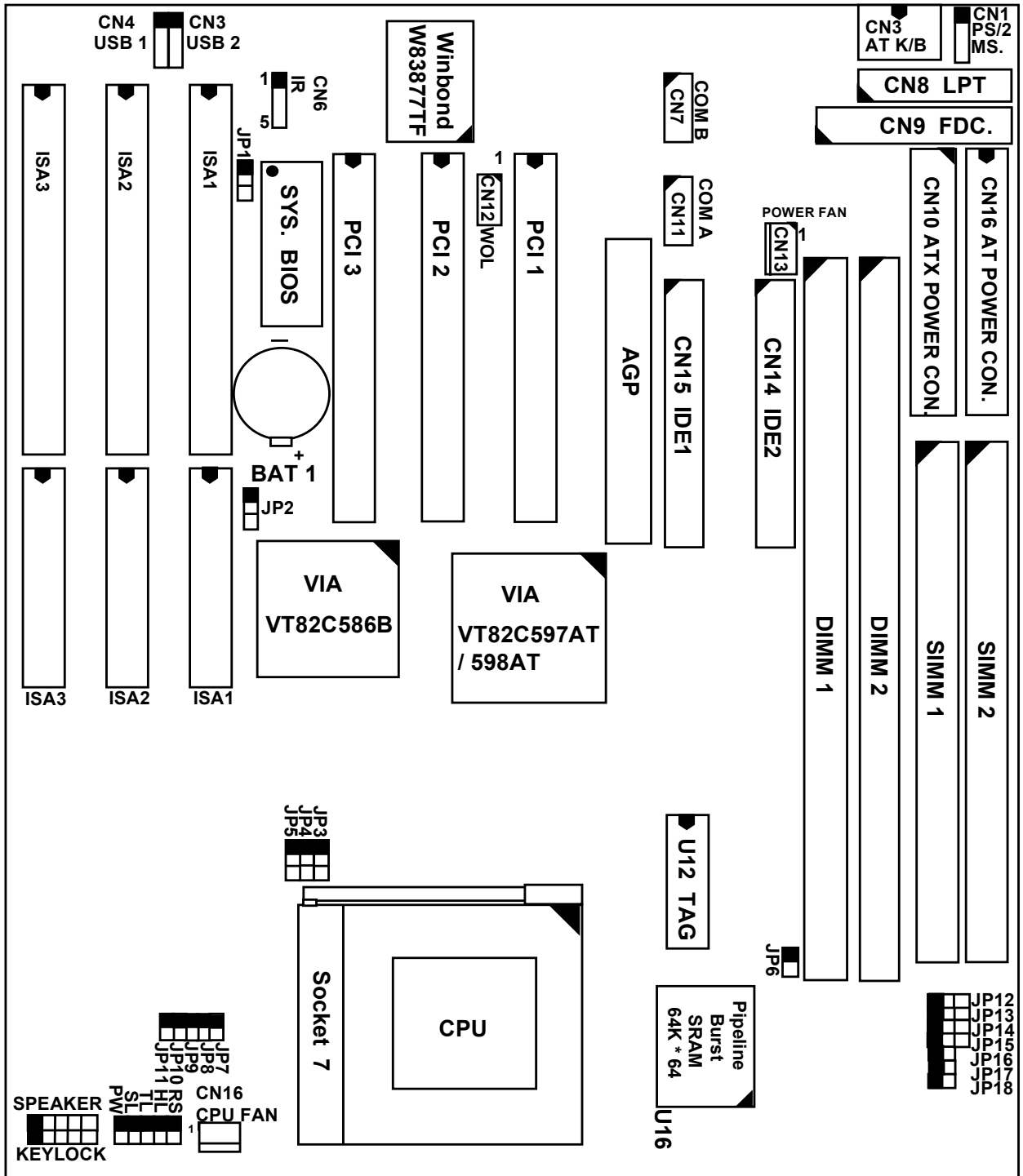

2. FEATURES

2.1 MAINBOARD SPECIFICATIONS

□ Chipset

VIA VP3 (VT82C597AT, VT82C586B (PT-5V3T)) / MVP (VT82C598AT, VT82C586B(PT-5VMT)) and Winbond W83877TF.

□ CPU

Intel : Pentium processor and OverDrive processor (P54C / P54CS / P54CTB / P55C) 75 / 90 / 100 / 120 / 133 / 150 / 166 / 200 / 233 MHz.

Cyrix : 6x86 / 6x86L - P120+ / P150+ / P166+ / P200+.
6x86MX - PR166 / PR200 / PR233 / PR266.

AMD : K5 - PR75 / PR90 / PR100 / PR120 / PR133 / PR150 / PR166.
K6 / PR2-166 / PR2-200 / PR2-233 / PR2-266.

IDT : Win Chip C6-180 / 200 / 225 / 240.

□ CPU Voltage

- (1).CPU I/O voltage : +3.3V DC or +3.5V DC.
- (2).CPU CORE voltage: +2.0V DC ~ +3.5V DC.

□ System Clock

50 / 60 / 66.6 / 75 MHz. (for VT82C597AT (PT-5V3T)).

60 / 66 / 75 / 83 / 90 / 100 MHz. (for VT82C598AT (PT-5VMT)).

□ Memory

DRAM : Three banks, each bank can be single or double sided, 8MB up to 1GB.

Supports fast page mode (FPM), Extended Data Out (EDO), and SDRAM memory (Use 72-pin SIMM module x 2, and 168-pin DIMM module x 2).

Support +3.3V DC operating voltage on DIMM sockets.

SRAM : 512KB pipelined burst SRAM on board.

□ BIOS

AWARD System BIOS. 128KB x 8 Flash ROM (for Plug & Play BIOS).

Expansion Slots

AGP Slots: 32-bit x 1 (Supports 1x/2x AGP graphics cards)
PCI Slots : 32-bit x 3 (All Master / Slave, PCI 2.1 Compliant).
ISA Slots : 16-bit x 3 (None PCI / ISA slot shared).

 Supports AT and ATX Power connector. **ACPI (Only available with ATX Power)**

1.Powered on by Panel-Switch, or Modem Ring-In.
2.Powered on by Keyboard, PS/2 Mouse, or LAN Signal. (optional)
3.Powered off (Soft-off) by OS or Panel-Switch.

 WOL (optional)

One WOL connector supports Wake-On-LAN (For ATX Power).

 IDE Ports

Two channel PIO and “Ultra DMA/33” Bus Master PCI IDE ports, which will connect maximum 4 IDE devices like IDE Hard Disk and ATAPI CD-ROM device. PIO Mode 4 transfer rate up to 14 Mbytes/s transfer rates and supports “Ultra DMA/33” mode transfers up to 33 Mbytes/sec.

 USB Ports

Two Universal Serial Bus (USB) ports.

 Super I/O Ports

1.Two high speed NS16C550 compatible Serial ports (UARTs).
2.One SPP / EPP / ECP mode Bi-directional parallel port.
3.One Floppy Disk Control port.

 IR Port

One HPSIR and ASKIR compatible Infrared port.

 Mouse and Keyboard

Supports PS/2 Mouse connector, PS/2 Keyboard connector (optional) and AT Keyboard connector.

☐ Hardware Monitoring (optional)

CPU voltage, CPU temperature, and two fan speed can be monitored by the mainboard. A series of beeping sounds will be alarming when malfunction.

☐ Software compatibility

MS-DOS, Windows NT, OS/2, UNIX, NOVELL, MS Windows, CAD/CAM, Memphis (Beta 2.1), ...etc.

☐ DIMENSION

Width & Length : 220 mm x 250 mm.

Height : 3/4 inches with components mounted.

PCB Thickness : 4-layers, 0.05 inches normal.

Weight : 20 ounces.

☐ ENVIRONMENT

Operating Temperature : 10°C to 40°C. (50°F to 104°F).

Require Airflow : 50 linear feet per minute across CPU.

Storage Temperature : -40°C to 70°C. (-40°F to 158°F).

Humidity : 0 to 90% non-condensing.

Altitude : 0 to 10,000 feet.

2.2 ADVANCED CONFIGURATION POWER INTERFACE (ACPI)

When the this mainboard has been assembled in a system successfully , there are several ways to power on the system. Please read the following description for all the details.

POWER BUTTON

The power button can be programmed by COM setup program and it has different features. Please refer to page 3-7 and the BIOS setup for detail function description.

RTC ALARM

PC system can be waked up by the RTC setting in the CMOS. You can set the alarming date and time in the RTC memory, When RTC alarms, the PC system will be triggered and wakes up automatically.

Enable the “Resume by Alarm” selection in the BIOS setup utility, and then input the accurate date and time in following fields. (please refer to Chapter 4 for the BIOS setup), Having stored the RTC alarm setting, the PC system will be turned on automatically according to the date and time which is recorded in the CMOS memory.

MODEM RING-IN

Everyone knows that a PC system can be used as a fax machine to send or receive fax messages. But most people still use fax machine to receive their messages because it is not practical to have the system powered on all day long waiting for the incoming messages. Now the problem can be solved by using the PT-5V3T/PT-5VMT mainboard. PT-5V3T/PT-5VMT can be triggered by a modem ring-in signal. When you have a external modem installed, you can leave the PC system power off. Whenever there is the incoming message, the PC system will be triggered by the ring-in signal and wake up automatically to receive the message for you. From now on, you can tell your PC system to receive the fax message for you.

In order to use the modem ring-in signal to wake up your PC system, you will have to use the **EXTERNAL MODEM** and have it connected to one of the **SERIAL PORTS** (COMA or COM B). When the system power is off, PT-5V3T/PT-5VMT will continue to detect the serial port status. When it detects the ring-in signal, the system power will be turned on and start to receive the incoming messages automatically. (you may need to have the software like Award Zero-Volt Data-Suspend Utility so that you can use the fax utility to receive the incoming fax message).

To enable the Modem Ring-In feature, you will have to use the BIOS setup utility and enable the “Resume by Ring or LAN” option (please refer Chapter 4 for BIOS setup). Having completed the BIOS setup, you have to reboot the PC system so that BIOS can verify the setting. (the “DMI pool data” will be verified by the BIOS when loading the operating system). Simply speaking, shut down the PC system and reboot the system. The modem ring-in feature will be enabled when the operation system has been loaded.

Note: This function is unavailable when using the internal MODEM card.

□ WAKE ON LAN (WOL)

There is a WOL connector (CN12,) on the mainboard which is designed onboard to connect to the signal from a LAN card that supports a Wake On LAN feature. When such LAN card is installed, you may turn on the PC system from your remote server and monitor the PC status.

To enable this feature, you will have to use the BIOS setup utility to enable the “Resume by Ring or LAN” (please refer to Chapter 4 for the BIOS setup). Having completed the BIOS setup, you have to reboot the PC system so that BIOS can verify the setting. (the “DMI pool data” will be verified by the BIOS when loading the operating system). Simply speaking, reboot the PC system, the Wake On LAN feature will be enabled when the operation system has been loaded

Note: This function will be disabled if you turn off the power before the system can verify the DMI pool data.

2.3 POWER OFF THE PC SYSTEM

There are two ways to power off the system. They are “Shut Down by Power Button” (please refer to page 3-28 for details) and “ Shut Down by OS”. (such as Windows® 95 and Windows® 98, you can choose the **Shut Down** from the file menu and the system will be powered off immediately).

3. HARDWARE SETUP

This chapter explains how to configure the mainboard hardware. When you are installing the mainboard, you will have to make jumper settings and cable connections. Please refer to the following sections for the details:

3.1 UNPACKING

The system board package contains the following parts :

- The PT-5V3T / 5VMT system board.
- OPERATION MANUAL.
- Cable set for IDE and I/O device.

The mainboard contains electric sensitive components which can be easily damaged by static electricity, please leave the mainboard sealed in its original packing until when installation.

Unpacking and installation shall be done on a grounded anti-static mat. The operator will have to wear an anti static wristband, grounded at the same point as the anti-static mat.

Inspect the mainboard carton to see whether there is any obvious damage. Shipping and handling may cause damage to your board. Be sure there is no shipping or handling damages on the board before proceeding.

After opening the motherboard carton, extract the mainboard and place it only on a grounded anti-static surface with the component side up. Inspect the board again to see whether there is any damage.

Press down on all of the socket IC's to make sure that they are properly seated. Do this only with the board placed on a firm flat surface.

3.2 HARDWARE CONFIGURATION

Before the system board is ready for operating, the hardware must be configured to make sure it will work properly with different environment. To configure the PT-5V3T/5VMT system board is a simple task, only a few jumpers, connectors, cables and sockets needs to be selected and installed. (For the detailed locations of each component please refer to the “system board layout figure” which appears in page 1-2.)

3.2.1 CONNECTORS

A connector is two or more pins that are used make connections to the system standard accessories (such as power, mouse, printer,...etc.). The following is a list of connectors on board, as well as descriptions of each individual connector.

(A) BAT1 Non-rechargeable battery (Using 3V Lithium battery : CR2032)

Pin # Assignment

+ Battery Positive
- Ground

(B) CN1 PS/2 Mouse connector

Pin # Assignment

1	●	1	Mouse Data
2		2	No Connection
3	●	3	Ground
4	●	4	+5V DC
5	●	5	Mouse Clock

(C) CN2 PS/2 Keyboard connector (optional)

Pin # Assignment

1 Keyboard Data
3 Ground
5 Keyboard Clock

Pin # Assignment

2 No Connection
4 +5V DC
6 No Connection

(D) CN3 USB 2 (Universal Serial Bus port 2) connector

1	●	1	+5V DC
	●	2	DATA-
	●	3	DATA+
	●	4	Ground
	●	5	Ground
5			

(E) CN4 USB 1 (Universal Serial Bus port 1) connector

	<u>Pin #</u>	<u>Assignment</u>
1	1	+5V DC
●	2	DATA-
●	3	DATA+
●	4	Ground
●	5	Ground
5		

(F) CN5 AT Keyboard connector

<u>Pin #</u>	<u>Assignment</u>	<u>Pin #</u>	<u>Assignment</u>
1	Keyboard Clock	2	Keyboard Data
3	No Connection	4	Ground
5	+5V DC		

(G) CN6 IR (Infrared Rays) transmission connector

	<u>Pin #</u>	<u>Assignment</u>
●	1	+5V DC
	2	No Connection
●	3	IR Receive
●	4	Ground
●	5	IR Transmit

(H) CN7 COM B (Serial Port 2) connector

1	2	<u>Pin #</u>	<u>Assignment</u>	<u>Pin #</u>	<u>Assignment</u>
●	●	1	DCD (Data Carrier Detect)	2	RD (Received Data)
●	●	3	TD (Transmit Data)	4	DTR (Data Terminal Ready)
●	●	5	Ground	6	DSR (Data Set Ready)
●	●	7	RTS (Request To Send)	8	CTS (Clear To Send)
●	●	9	RI (Ring Indicator)	10	No Connection
9	10				

(I) CN8 Parallel Port Connector
 (Supports SPP/EPP/ECP mode, using IRQ7 or IRQ5, ECP modes use DMA channel 3 or channel 1, and it can be programmed by CMOS setup)

1 14	<u>Pin #</u>	<u>Assignment</u>	<u>Pin #</u>	<u>Assignment</u>
● ●	1	STROBE-	14	AUTO FEED-
● ●	2	Data Bit 0	15	ERROR-
● ●	3	Data Bit 1	16	INIT-
● ●	4	Data Bit 2	17	SLCT IN-
● ●	5	Data Bit 3	18	Ground
● ●	6	Data Bit 4	19	Ground
● ●	7	Data Bit 5	20	Ground
● ●	8	Data Bit 6	21	Ground
● ●	9	Data Bit 7	22	Ground
● ●	10	ACK-	23	Ground
● ●	11	BUSY	24	Ground
● ●	12	PE	25	Ground
● ●	13	SLCT	26	No Connection

(J) CN9 Floppy Disk Control Port connector (Using IRQ6, DMA channel 2)

(K) CN10 AT Power connector

<u>Pin #</u>	<u>Assignment</u>
1	Power Good
2	+5V DC
3	+12V DC
4	-12V DC
5	Ground
6	Ground
7	Ground
8	Ground
9	-5V DC
10	+5V DC
11	+5V DC
12	+5V DC

(L) CN11 COM A (Serial Port 1) connector

<u>Pin #</u>	<u>Assignment</u>	<u>Pin #</u>	<u>Assignment</u>
1	DCD (Data Carrier Detect)	2	RD (Received Data)
3	TD (Transmit Data)	4	DTR (Data Terminal Ready)
5	Ground	6	DSR (Data Set Ready)
7	RTS (Request To Send)	8	CTS (Clear To Send)
9	RI (Ring Indicator)	10	No Connection

(M) CN12 WOL (Wake On LAN) connector

<u>Pin #</u>	<u>Assignment</u>
1	5V standby
2	Ground
3	WOL Signal

(N) CN13 POWER FAN connector

<u>Pin #</u>	<u>Assignment</u>
1	GND
2	+12V DC
3	SIN (Fan Sense Signal)

(O) CN14 IDE 2 connector (Secondary IDE Port, using IRQ15)

(P) CN15 IDE 1 connector (Primary IDE Port, using IRQ14)

(Q) CN16 ATX Power connector

<u>Pin #</u>	<u>Assignment</u>	<u>Pin #</u>	<u>Assignment</u>
1	+3.3V DC	2	+3.3V DC
2	Ground	4	+5V DC
5	Ground	6	+5V DC
7	Ground	8	PW_OK
9	+5V DC	10	+12V DC
11	+3.3V DC	12	-12V DC
13	Ground	14	PS-ON
15	Ground	16	Ground
17	Ground	18	-5V DC
19	+5V DC	20	+5V DC

(R) CN17 CPU Cooling Fan Power connector

	<u>Pin #</u>	<u>Assignment</u>
●	1	Ground
●	2	+12V DC
●	3	Fan Sense Signal

(S) KEYLOCK Front Panel Power LED & Key-Lock connector

	<u>Pin #</u>	<u>Assignment</u>
●	1	Pullup (+5V DC for Power LED)
●	2	No Connection
●	3	Ground
●	4	Keyboard Lock
●	5	Ground

(T) SPEAKER Speaker connector

	<u>Pin #</u>	<u>Assignment</u>
●	1	+5V DC
●	2	No Connection
●	3	No Connection
●	4	Speaker Data Signal

(U) RS Reset Button connector

Open : No action

Short : System Reset

Pin # Assignment

Pin # Assignment

1 Ground

2 Reset Control

(V) HL IDE HDD LED connector

Pin # Assignment

Pin # Assignment

1 Pullup (+5V DC)

2 Signal Pin

(W) SL Sleep LED connector

When ATX Power is Off : LED Turn On

When ATX Power is On : LED Turn Off

Pin # Assignment

1 Signal Pin

Pin # Assignment

2 Ground

(X) PW Power On / Off and External Suspend Switch Connector

According to the setup in CMOS, the PW connector has two functions. It can be the Power Switch or Suspend Switch of your PC system. (the PW switch can be programmed by the BIOS setup “Soft-off by PWR-BTTN”)

① **If the setup in CMOS is “Delay 4 Sec.”, the switch function will be:**

A. When system is power off :

Press this switch, the system will power on.

B. When system power is on :

a. The system is in Full-ON mode :

a-1. Click on this switch (less than 4 seconds), the system will be turned into Suspend mode. (turn into the GREEN mode)

a-2. Press and hold this switch for more than 4 seconds, the system will be powered off.

b. When the system is in Suspend mode :

b-1. Click on this switch (less than 4 seconds), the system will return to Full-ON mode.

b-2. Press and hold this switch more than 4 seconds, the system will be powered off.

② **The setup in CMOS is “Instant-off”:**

A. When system power is off :

Click on this switch, the system will be powered on.

B. When system power is on :

Click on this switch, the system will be powered off instantly.

3.2.2 JUMPERS

A jumper is a set of two, three or more jumper pins which allows you to make different system configuration by putting the plastic connector plug (mini-jumper) on it. The jumper setting is necessary when installing different components onto the mainboard. ***Please make sure all jumper settings are correct before you can start the installation.***

(A) JP13, JP14, JP15, JP16, JP17, JP18: CPU type selection

The jumper settings to select the CPU type are different between PT-5V3T and PT-5VMT, please refer to the followings for the details

(a) VT82C597AT (PT-5V3T)

(1) 50MHz x 1.5

JUMPERS			CPU TYPE	
	1	2	3	
	●	○	○	JP13
1	●	○	○	JP14
1	●	○	○	JP15
1	●	●		JP16
1	●	●		JP17
1	●	●		JP18

(2) 60MHz x 1.5

JUMPERS			CPU TYPE	
	1	2	3	
	●	○	○	JP13
1	○	○	●	JP14
1	○	○	●	JP15
1	●	●		JP16
1	●	●		JP17
1	●	●		JP18

(3) 66MHz x 1.5 / 66MHz x 3.5

JUMPERS			CPU TYPE	
	1	2	3	
	○	○	●	JP13
1	○	○	●	JP14
1	○	○	●	JP15
1	●	●		JP16
1	●	●		JP17
1	●	●		JP18

(4) 50MHz x 2

JUMPERS			CPU TYPE	
	1	2	3	
	●	○	○	JP13
1	●	○	○	JP14
1	●	○	○	JP15
1	○	○		JP16
1	●	●		JP17
1	●	●		JP18

(5) 60MHz x 2

JUMPERS			CPU TYPE
1	2	3	
1	●	○	JP13
1	○	○	JP14
1	○	○	JP15
1	○	○	JP16
1	●	●	JP17
1	●	●	JP18
			Intel 80502-120
			Cyrix 6x86 / 6x86L -P150+

(6) 66MHz x 2

JUMPERS			CPU TYPE
1	2	3	
1	○	○	JP13
1	○	○	JP14
1	○	○	JP15
1	○	○	JP16
1	●	●	JP17
1	●	●	JP18
			Intel 80502-133
			Cyrix 6x86 / 6x86L -P166+ 6x86MX-PR166

(7) 75MHz x 2

JUMPERS			CPU TYPE
1	2	3	
1	○	○	JP13
1	○	○	JP14
1	○	○	JP15
1	○	○	JP16
1	●	●	JP17
1	●	●	JP18
			Cyrix 6x86 / 6x86L -P200+ 6x86MX-PR200

(8) 60MHz x 2.5

JUMPERS			CPU TYPE
1	2	3	
1	○	○	JP13
1	○	○	JP14
1	○	○	JP15
1	○	○	JP16
1	○	○	JP17
1	●	●	JP18
			Intel 80502-150
			AMD K5-PR150
			Cyrix 6x86MX -PR166







(9) 66MHz x 2.5

JUMPERS			CPU TYPE
1	2	3	
1	○	○	JP13
1	○	○	JP14
1	○	○	JP15
1	○	○	JP16
1	○	○	JP17
1	●	●	JP18
			Intel 80502-166 80503-166
			AMD K5-PR166 K6/PR2-166
			Cyrix 6x86MX -PR200







(10) 75MHz x 2.5

JUMPERS			CPU TYPE
1	2	3	
1	○	○	JP13
1	○	○	JP14
1	○	○	JP15
1	○	○	JP16
1	○	○	JP17
1	●	●	JP18
			Cyrix 6x86MX -PR233





(11) 60MHz x 3

JUMPERS		CPU TYPE
1	 JP13	IDT Win-Chip C6-180
1	 JP14	
1	 JP15	
1	 JP16	
1	 JP17	
1	 JP18	





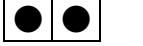

(12) 66MHz x 3

JUMPERS		CPU TYPE
	1 2 3	
1	 JP13	Intel 80502-200 80503-200
1	 JP14	
1	 JP15	AMD K6/PR2-200 IDT Win-Chip C6-200 Cyrix 6x86MX -PR233
1	 JP16	
1	 JP17	
1	 JP18	







(11) 75MHz x 3

JUMPERS		CPU TYPE
	1 2 3	
1	 JP13	IDT Win-Chip C6-225 Cyrix 6x86MX -PR266
1	 JP14	
1	 JP15	
1	 JP16	
1	 JP17	
1	 JP18	







(12) 60MHz x 4

JUMPERS		CPU TYPE
	1 2 3	
1	 JP13	IDT Win-Chip C6-240
1	 JP14	
1	 JP15	
1	 JP16	
1	 JP17	
1	 JP18	

(13) 66MHz x 4

JUMPERS		CPU TYPE
	1 2 3	
1	 JP13	AMD K6/PR2-266
1	 JP14	
1	 JP15	
1	 JP16	
1	 JP17	
1	 JP18	

(14) 66MHz x4.5

JUMPERS		CPU TYPE
	1 2 3	
1	 JP13	AMD K6/PR2-300
1	 JP14	
1	 JP15	
1	 JP16	
1	 JP17	
1	 JP18	

(13) 66MHz x 5

JUMPERS			CPU TYPE
1	2	3	
1	○ ○ ●	JP13	
1	○ ○ ●	JP14	
1	○ ○ ●	JP15	
1	● ●	JP16	
1	○ ○	JP17	
1	○ ○	JP18	

(b) VT82C598AT (PT-5VMT)

(1) 60MHz x 1.5

JUMPERS			CPU TYPE
1	2	3	
1	● ○ ○	JP13	Intel 80502-90
1	● ○ ○	JP14	AMD K5-PR90 K5-PR120
1	● ○ ○	JP15	
1	● ●	JP16	
1	● ●	JP17	
1	● ●	JP18	

(2) 66MHz x 1.5 / 66MHz x 3.5

JUMPERS			CPU TUPE
1	2	3	
1	○ ○ ●	JP13	Intel 80502-100 80503-233
1	● ○ ○	JP14	AMD K5-PR100
1	● ○ ○	JP15	K5-PR133
1	● ●	JP16	K6/PR2-233
1	● ●	JP17	Cyrix 6x86MX -PR266
1	● ●	JP18	

(3) 100MHz x 1.5 / 100MHz x 3.5

JUMPERS			CPU TYPE
1	2	3	
1	○ ○ ●	JP13	
1	○ ○ ●	JP14	
1	○ ○ ●	JP15	
1	● ●	JP16	
1	● ●	JP17	
1	● ●	JP18	

(4) 60MHz x 2

JUMPERS			CPU TUPE
1	2	3	
1	● ○ ○	JP13	
1	● ○ ○	JP14	
1	● ○ ○	JP15	
1	○ ○	JP16	
1	● ●	JP17	
1	● ●	JP18	

(5) 66MHz x 2

JUMPERS			CPU TYPE
1	2	3	
1		JP13	Intel 80502-133
1		JP14	
1		JP15	Cyrix 6x86/6x86L -P166+
1		JP16	
1		JP17	
1		JP18	

(6) 75MHz x2

JUMPERS			CPU TUPE
1		JP13	Cyrix 6x86/6x86L -P200+
1		JP14	
1		JP15	
1		JP16	
1		JP17	
1		JP18	

(7) 83MHz x2

JUMPERS			CPU TYPE
1	2	3	
1		JP13	
1		JP14	
1		JP15	
1		JP16	
1		JP17	
1		JP18	

(8) 90MHz x 2

JUMPERS			CPU TUPE
1		JP13	
1		JP14	
1		JP15	
1		JP16	
1		JP17	
1		JP18	

(9) 100MHz x 2

JUMPERS			CPU TYPE
1	2	3	
1		JP13	
1		JP14	
1		JP15	
1		JP16	
1		JP17	
1		JP18	

(10) 60MHz x 2.5

JUMPERS			CPU TUPE
1		JP13	Intel 80502-150
1		JP14	AMD K5-PR150
1		JP15	Cyrix 6x86MX -PR166
1		JP16	
1		JP17	
1		JP18	

(11) 66MHz x 2.5

JUMPERS			CPU TYPE
1	2	3	
1	○ ○ ●	JP13	Intel 80502-166
1	● ○ ○	JP14	80503-166
1	● ○ ○	JP15	AMD K5-PR166
1	○ ○	JP16	K6/PR2-166
1	○ ○	JP17	Cyrix 6x86MX
1	● ●	JP18	-PR200

(12) 75MHz x 2.5

JUMPERS			CPU TUPE
1	● ○ ○	JP13	Cyrix 6x86MX -PR233
1	● ○ ○	JP14	
1	○ ○ ●	JP15	
1	○ ○	JP16	
1	○ ○	JP17	
1	● ●	JP18	

(13) 83MHz x 2.5

JUMPERS			CPU TYPE
1	2	3	
1	○ ○ ●	JP13	
1	● ○ ○	JP14	
1	○ ○ ●	JP15	
1	○ ○	JP16	
1	○ ○	JP17	
1	● ●	JP18	

(14) 90MHz x 2.5

JUMPERS			CPU TUPE
1	● ○ ○	JP13	
1	○ ○ ●	JP14	
1	○ ○ ●	JP15	
1	○ ○	JP16	
1	○ ○	JP17	
1	● ●	JP18	

(15) 100MHz x2.5

JUMPERS			CPU TYPE
1	2	3	
1	○ ○ ●	JP13	
1	○ ○ ●	JP14	
1	○ ○ ●	JP15	
1	○ ○	JP16	
1	○ ○	JP17	
1	● ●	JP18	

(16) 66MHz x 3

JUMPERS			CPU TUPE
1	○ ○ ●	JP13	Intel 80502-200
1	● ○ ○	JP14	80503-200
1	● ○ ○	JP15	AMD K6/PR2-200
1	● ●	JP16	Cyrix 6x86MX
1	○ ○	JP17	-PR233
1	● ●	JP18	

(19) 100MHz x 3

JUMPERS			CPU TYPE
1	2	3	
1	○ ○ ●	JP13	
1	○ ○ ●	JP14	
1	○ ○ ●	JP15	
1	● ●	JP16	
1	○ ○	JP17	
1	● ●	JP18	

(20) 100MHz x 4

JUMPERS			CPU TUPE
1	○ ○ ●	JP13	
1	○ ○ ●	JP14	
1	○ ○ ●	JP15	
1	○ ○	JP16	
1	● ●	JP17	
1	○ ○	JP18	

(21) 100MHz x 4.5

JUMPERS			CPU TYPE
1	2	3	
1	○ ○ ●	JP13	
1	○ ○ ●	JP14	
1	○ ○ ●	JP15	
1	○ ○	JP16	
1	○ ○	JP17	
1	○ ○	JP18	

(22) 100MHz x 5

JUMPERS			CPU TUPE
1	○ ○ ●	JP13	
1	○ ○ ●	JP14	
1	○ ○ ●	JP15	
1	● ●	JP16	
1	○ ○	JP17	
1	○ ○	JP18	

(23) 100MHz x 5.5

JUMPERS			CPU TYPE
1	2	3	
1	○ ○ ●	JP13	
1	○ ○ ●	JP14	
1	○ ○ ●	JP15	
1	● ●	JP16	
1	● ●	JP17	
1	○ ○	JP18	

NOTE : Cyrix 6x86 / 6x86L-P200+

You may select 75MHz x 2 in order to have better system performance, but some peripheral may have compatibility problem with this mainboard because 75MHz is not recommended by Intel. Nevertheless, you can choose 50MHz x 3 as the system clock when you are using the Cyrix processor.

(B) JP7, JP8, JP9, JP10, JP11 CPU CORE voltage selection

JUMPERS	CORE Voltage	IO Voltage	CPU TYPE																								
<table border="1"> <tr> <td></td> <td>1</td> <td>2</td> <td></td> </tr> <tr> <td>1</td> <td>●</td> <td>●</td> <td>JP7</td> </tr> <tr> <td>1</td> <td>○</td> <td>○</td> <td>JP8</td> </tr> <tr> <td>1</td> <td>○</td> <td>○</td> <td>JP9</td> </tr> <tr> <td>1</td> <td>○</td> <td>○</td> <td>JP10</td> </tr> <tr> <td>1</td> <td>○</td> <td>○</td> <td>JP11</td> </tr> </table>		1	2		1	●	●	JP7	1	○	○	JP8	1	○	○	JP9	1	○	○	JP10	1	○	○	JP11	3.5V	3.5V	AMD K5 Cyrix 6x86 IDT C6
	1	2																									
1	●	●	JP7																								
1	○	○	JP8																								
1	○	○	JP9																								
1	○	○	JP10																								
1	○	○	JP11																								

JUMPERS	CORE Voltage	IO Voltage	CPU TYPE																								
<table border="1"> <tr> <td></td> <td>1</td> <td>2</td> <td></td> </tr> <tr> <td>1</td> <td>●</td> <td>●</td> <td>JP7</td> </tr> <tr> <td>1</td> <td>○</td> <td>○</td> <td>JP8</td> </tr> <tr> <td>1</td> <td>○</td> <td>○</td> <td>JP9</td> </tr> <tr> <td>1</td> <td>○</td> <td>○</td> <td>JP10</td> </tr> <tr> <td>1</td> <td>●</td> <td>●</td> <td>JP11</td> </tr> </table>		1	2		1	●	●	JP7	1	○	○	JP8	1	○	○	JP9	1	○	○	JP10	1	●	●	JP11	3.4V	3.4V	Intel P54C (80502) Cyrix 6x86
	1	2																									
1	●	●	JP7																								
1	○	○	JP8																								
1	○	○	JP9																								
1	○	○	JP10																								
1	●	●	JP11																								

JUMPERS	CORE Voltage	IO Voltage	CPU TYPE																								
<table border="1"> <tr> <td></td> <td>1</td> <td>2</td> <td></td> </tr> <tr> <td>1</td> <td>●</td> <td>●</td> <td>JP7</td> </tr> <tr> <td>1</td> <td>○</td> <td>○</td> <td>JP8</td> </tr> <tr> <td>1</td> <td>○</td> <td>○</td> <td>JP9</td> </tr> <tr> <td>1</td> <td>●</td> <td>●</td> <td>JP10</td> </tr> <tr> <td>1</td> <td>○</td> <td>○</td> <td>JP11</td> </tr> </table>		1	2		1	●	●	JP7	1	○	○	JP8	1	○	○	JP9	1	●	●	JP10	1	○	○	JP11	3.3V	3.3V	IDT C6
	1	2																									
1	●	●	JP7																								
1	○	○	JP8																								
1	○	○	JP9																								
1	●	●	JP10																								
1	○	○	JP11																								

JUMPERS	CORE Voltage	IO Voltage	CPU TYPE																								
<table border="1"> <tr> <td></td> <td>1</td> <td>2</td> <td></td> </tr> <tr> <td>1</td> <td>●</td> <td>●</td> <td>JP7</td> </tr> <tr> <td>1</td> <td>○</td> <td>○</td> <td>JP8</td> </tr> <tr> <td>1</td> <td>○</td> <td>○</td> <td>JP9</td> </tr> <tr> <td>1</td> <td>●</td> <td>●</td> <td>JP10</td> </tr> <tr> <td>1</td> <td>●</td> <td>●</td> <td>JP11</td> </tr> </table>		1	2		1	●	●	JP7	1	○	○	JP8	1	○	○	JP9	1	●	●	JP10	1	●	●	JP11	3.2V	3.3V	AMD K6/PR2-233
	1	2																									
1	●	●	JP7																								
1	○	○	JP8																								
1	○	○	JP9																								
1	●	●	JP10																								
1	●	●	JP11																								

JUMPERS	CORE Voltage	IO Voltage	CPU TYPE																								
<table border="1"> <tr><td></td><td>1</td><td>2</td><td></td></tr> <tr><td>1</td><td>●</td><td>●</td><td>JP7</td></tr> <tr><td>1</td><td>○</td><td>○</td><td>JP8</td></tr> <tr><td>1</td><td>●</td><td>●</td><td>JP9</td></tr> <tr><td>1</td><td>○</td><td>○</td><td>JP10</td></tr> <tr><td>1</td><td>○</td><td>○</td><td>JP11</td></tr> </table>		1	2		1	●	●	JP7	1	○	○	JP8	1	●	●	JP9	1	○	○	JP10	1	○	○	JP11	3.1V	3.3V	
	1	2																									
1	●	●	JP7																								
1	○	○	JP8																								
1	●	●	JP9																								
1	○	○	JP10																								
1	○	○	JP11																								

JUMPERS	CORE Voltage	IO Voltage	CPU TYPE																								
<table border="1"> <tr><td></td><td>1</td><td>2</td><td></td></tr> <tr><td>1</td><td>●</td><td>●</td><td>JP7</td></tr> <tr><td>1</td><td>○</td><td>○</td><td>JP8</td></tr> <tr><td>1</td><td>●</td><td>●</td><td>JP9</td></tr> <tr><td>1</td><td>○</td><td>○</td><td>JP10</td></tr> <tr><td>1</td><td>●</td><td>●</td><td>JP11</td></tr> </table>		1	2		1	●	●	JP7	1	○	○	JP8	1	●	●	JP9	1	○	○	JP10	1	●	●	JP11	3.0V	3.3V	
	1	2																									
1	●	●	JP7																								
1	○	○	JP8																								
1	●	●	JP9																								
1	○	○	JP10																								
1	●	●	JP11																								

JUMPERS	CORE Voltage	IO Voltage	CPU TYPE																								
<table border="1"> <tr><td></td><td>1</td><td>2</td><td></td></tr> <tr><td>1</td><td>●</td><td>●</td><td>JP7</td></tr> <tr><td>1</td><td>○</td><td>○</td><td>JP8</td></tr> <tr><td>1</td><td>●</td><td>●</td><td>JP9</td></tr> <tr><td>1</td><td>●</td><td>●</td><td>JP10</td></tr> <tr><td>1</td><td>○</td><td>○</td><td>JP11</td></tr> </table>		1	2		1	●	●	JP7	1	○	○	JP8	1	●	●	JP9	1	●	●	JP10	1	○	○	JP11	2.9V	3.3V	AMD K6/PR2-166 AMD K6/PR2-200 Cyrix 6x86MX
	1	2																									
1	●	●	JP7																								
1	○	○	JP8																								
1	●	●	JP9																								
1	●	●	JP10																								
1	○	○	JP11																								

JUMPERS	CORE Voltage	IO Voltage	CPU TYPE																								
<table border="1"> <tr><td></td><td>1</td><td>2</td><td></td></tr> <tr><td>1</td><td>●</td><td>●</td><td>JP7</td></tr> <tr><td>1</td><td>○</td><td>○</td><td>JP8</td></tr> <tr><td>1</td><td>●</td><td>●</td><td>JP9</td></tr> <tr><td>1</td><td>●</td><td>●</td><td>JP10</td></tr> <tr><td>1</td><td>●</td><td>●</td><td>JP11</td></tr> </table>		1	2		1	●	●	JP7	1	○	○	JP8	1	●	●	JP9	1	●	●	JP10	1	●	●	JP11	2.8V	3.3V	Intel P55C (80503) Cyrix 6x86L
	1	2																									
1	●	●	JP7																								
1	○	○	JP8																								
1	●	●	JP9																								
1	●	●	JP10																								
1	●	●	JP11																								

JUMPERS	CORE Voltage	IO Voltage	CPU TYPE																								
<table border="1"> <tr><td></td><td>1</td><td>2</td><td></td></tr> <tr><td>1</td><td>●</td><td>●</td><td>JP7</td></tr> <tr><td>1</td><td>●</td><td>●</td><td>JP8</td></tr> <tr><td>1</td><td>○</td><td>○</td><td>JP9</td></tr> <tr><td>1</td><td>○</td><td>○</td><td>JP10</td></tr> <tr><td>1</td><td>○</td><td>○</td><td>JP11</td></tr> </table>		1	2		1	●	●	JP7	1	●	●	JP8	1	○	○	JP9	1	○	○	JP10	1	○	○	JP11	2.7V	3.3V	
	1	2																									
1	●	●	JP7																								
1	●	●	JP8																								
1	○	○	JP9																								
1	○	○	JP10																								
1	○	○	JP11																								

JUMPERS	CORE Voltage	IO Voltage	CPU TYPE																								
<table border="1"> <tr><td></td><td>1</td><td>2</td><td></td></tr> <tr><td>1</td><td>●</td><td>●</td><td>JP7</td></tr> <tr><td>1</td><td>●</td><td>●</td><td>JP8</td></tr> <tr><td>1</td><td>○</td><td>○</td><td>JP9</td></tr> <tr><td>1</td><td>○</td><td>○</td><td>JP10</td></tr> <tr><td>1</td><td>●</td><td>●</td><td>JP11</td></tr> </table>		1	2		1	●	●	JP7	1	●	●	JP8	1	○	○	JP9	1	○	○	JP10	1	●	●	JP11	2.6V	3.3V	
	1	2																									
1	●	●	JP7																								
1	●	●	JP8																								
1	○	○	JP9																								
1	○	○	JP10																								
1	●	●	JP11																								

JUMPERS	CORE Voltage	IO Voltage	CPU TYPE																								
<table border="1"> <tr><td></td><td>1</td><td>2</td><td></td></tr> <tr><td>1</td><td>●</td><td>●</td><td>JP7</td></tr> <tr><td>1</td><td>●</td><td>●</td><td>JP8</td></tr> <tr><td>1</td><td>○</td><td>○</td><td>JP9</td></tr> <tr><td>1</td><td>●</td><td>●</td><td>JP10</td></tr> <tr><td>1</td><td>○</td><td>○</td><td>JP11</td></tr> </table>		1	2		1	●	●	JP7	1	●	●	JP8	1	○	○	JP9	1	●	●	JP10	1	○	○	JP11	2.5V	3.3V	
	1	2																									
1	●	●	JP7																								
1	●	●	JP8																								
1	○	○	JP9																								
1	●	●	JP10																								
1	○	○	JP11																								

JUMPERS	CORE Voltage	IO Voltage	CPU TYPE																								
<table border="1"> <tr><td></td><td>1</td><td>2</td><td></td></tr> <tr><td>1</td><td>●</td><td>●</td><td>JP7</td></tr> <tr><td>1</td><td>●</td><td>●</td><td>JP8</td></tr> <tr><td>1</td><td>○</td><td>○</td><td>JP9</td></tr> <tr><td>1</td><td>●</td><td>●</td><td>JP10</td></tr> <tr><td>1</td><td>●</td><td>●</td><td>JP11</td></tr> </table>		1	2		1	●	●	JP7	1	●	●	JP8	1	○	○	JP9	1	●	●	JP10	1	●	●	JP11	2.4V	3.3V	
	1	2																									
1	●	●	JP7																								
1	●	●	JP8																								
1	○	○	JP9																								
1	●	●	JP10																								
1	●	●	JP11																								

JUMPERS	CORE Voltage	IO Voltage	CPU TYPE																								
<table border="1"> <tr> <td></td> <td>1</td> <td>2</td> <td></td> </tr> <tr> <td>1</td> <td>●</td> <td>●</td> <td>JP7</td> </tr> <tr> <td>1</td> <td>●</td> <td>●</td> <td>JP8</td> </tr> <tr> <td>1</td> <td>●</td> <td>●</td> <td>JP9</td> </tr> <tr> <td>1</td> <td>○</td> <td>○</td> <td>JP10</td> </tr> <tr> <td>1</td> <td>○</td> <td>○</td> <td>JP11</td> </tr> </table>		1	2		1	●	●	JP7	1	●	●	JP8	1	●	●	JP9	1	○	○	JP10	1	○	○	JP11	2.3V	3.3V	
	1	2																									
1	●	●	JP7																								
1	●	●	JP8																								
1	●	●	JP9																								
1	○	○	JP10																								
1	○	○	JP11																								

JUMPERS	CORE Voltage	IO Voltage	CPU TYPE																								
<table border="1"> <tr> <td></td> <td>1</td> <td>2</td> <td></td> </tr> <tr> <td>1</td> <td>●</td> <td>●</td> <td>JP7</td> </tr> <tr> <td>1</td> <td>●</td> <td>●</td> <td>JP8</td> </tr> <tr> <td>1</td> <td>●</td> <td>●</td> <td>JP9</td> </tr> <tr> <td>1</td> <td>○</td> <td>○</td> <td>JP10</td> </tr> <tr> <td>1</td> <td>●</td> <td>●</td> <td>JP11</td> </tr> </table>		1	2		1	●	●	JP7	1	●	●	JP8	1	●	●	JP9	1	○	○	JP10	1	●	●	JP11	2.2V	3.3V	
	1	2																									
1	●	●	JP7																								
1	●	●	JP8																								
1	●	●	JP9																								
1	○	○	JP10																								
1	●	●	JP11																								

JUMPERS	CORE Voltage	IO Voltage	CPU TYPE																								
<table border="1"> <tr> <td></td> <td>1</td> <td>2</td> <td></td> </tr> <tr> <td>1</td> <td>●</td> <td>●</td> <td>JP7</td> </tr> <tr> <td>1</td> <td>●</td> <td>●</td> <td>JP8</td> </tr> <tr> <td>1</td> <td>●</td> <td>●</td> <td>JP9</td> </tr> <tr> <td>1</td> <td>●</td> <td>●</td> <td>JP10</td> </tr> <tr> <td>1</td> <td>○</td> <td>○</td> <td>JP11</td> </tr> </table>		1	2		1	●	●	JP7	1	●	●	JP8	1	●	●	JP9	1	●	●	JP10	1	○	○	JP11	2.1V	3.3V	
	1	2																									
1	●	●	JP7																								
1	●	●	JP8																								
1	●	●	JP9																								
1	●	●	JP10																								
1	○	○	JP11																								

JUMPERS	CORE Voltage	IO Voltage	CPU TYPE																								
<table border="1"> <tr> <td></td> <td>1</td> <td>2</td> <td></td> </tr> <tr> <td>1</td> <td>●</td> <td>●</td> <td>JP7</td> </tr> <tr> <td>1</td> <td>●</td> <td>●</td> <td>JP8</td> </tr> <tr> <td>1</td> <td>●</td> <td>●</td> <td>JP9</td> </tr> <tr> <td>1</td> <td>●</td> <td>●</td> <td>JP10</td> </tr> <tr> <td>1</td> <td>●</td> <td>●</td> <td>JP11</td> </tr> </table>		1	2		1	●	●	JP7	1	●	●	JP8	1	●	●	JP9	1	●	●	JP10	1	●	●	JP11	2.0V	3.3V	
	1	2																									
1	●	●	JP7																								
1	●	●	JP8																								
1	●	●	JP9																								
1	●	●	JP10																								
1	●	●	JP11																								

(C) JP1 ROM BIOS selection (option)





Different types of Flash ROM can be used on the mainboard and they may have different DV voltage requirement. Basically, the jumper setting is always made by factory and you do not have to make any change on this jumper. Following is the setting to select the voltage for the Flash ROM:





<u>Pin #</u>	<u>Function</u>
1-2	for +5V FLASH ROM
2-3	for +12V FLASH ROM

(D) JP2 Clear CMOS button

<u>Pin #</u>	<u>Function</u>
1-2	Normal Operation
2-3	Clear CMOS

(E) JP3, JP4, JP5, JP12 DRAM Clock selection

JUMPERS	FUNCTION
 JP3	AGPCLK will be used in the DRAM subsystem
 JP4	
 JP5	
 JP12	

JUMPERS	FUNCTION
 JP3	CPUCLK will be used in the DRAM subsystem
 JP4	
 JP5	
 JP12	

(F) JP6 Cyrix Linear Burst Mode

<u>Pin #</u>	<u>Function</u>
Open	For other CPUs
Short	For Cyrix CPU

3.3 INSTALLING A CPU ONTO THE ZIF SOCKET

The ZIP type Socket located on U13 is the so called Socket 7. It is designed for the Pentium or other equivalent processors. inserting the Pentium processor onto the Socket 7, certain precautionary steps must be followed. The following diagrams will show you how to install the CPU step by step.

1. Make sure the ZIF socket level is up.

To raise the lever, pull it out to the side a little and raise it as far as it will go. Pin 1 is at the arm corner.

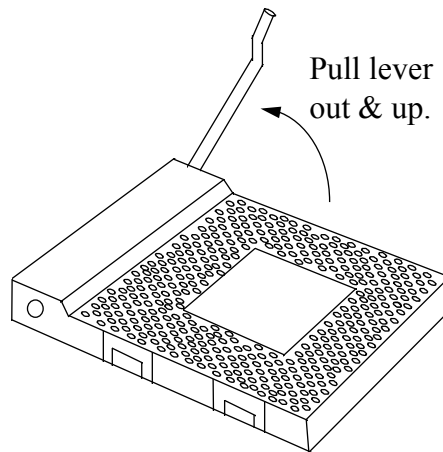

2. Align the CPU and socket pin 1 corners. Match the processor corner containing the blunt edge and the white dot to the socket corner with the distinctive pin arrangement. The pins on the bottom should have aligned with the inner 3 rings of holes in the socket, Place the CPU into the socket and it will go into the socket easily. If it won't, pull the level up a little more and try again.

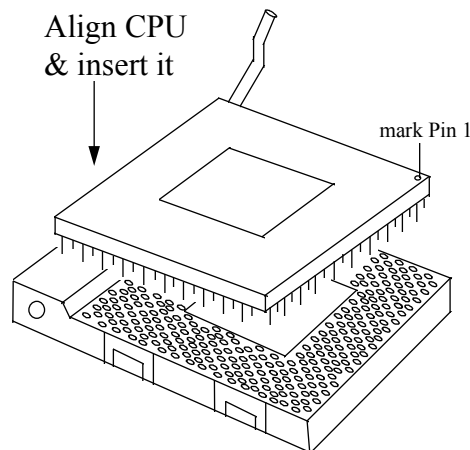

3. Press the lever down. The plate will slide forward. You will feel some resistance as the pressure starts to secure the CPU in the socket. When the CPU is installed, the lever will snap into place at the side of the socket.

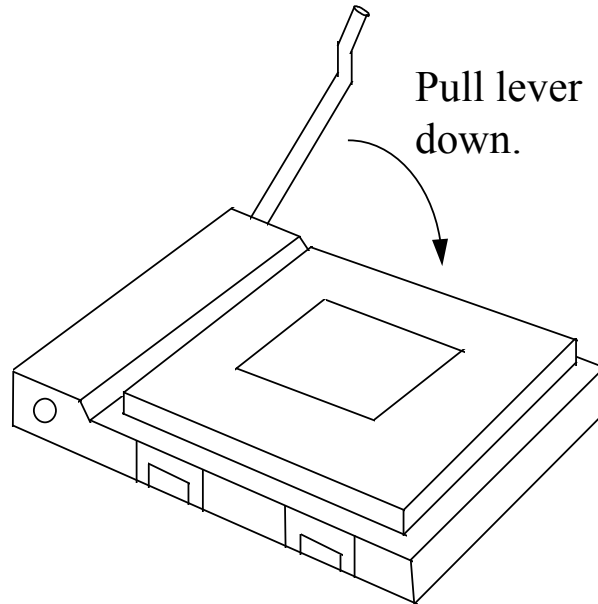

3.4 INSTALLATION OF CPU COOLING FAN

Improper installation of CPU cooling fan may cause serious damage to the motherboard. Please follow the procedures carefully:

1. There is a metal clip attached to the CPU cooler as shown below.

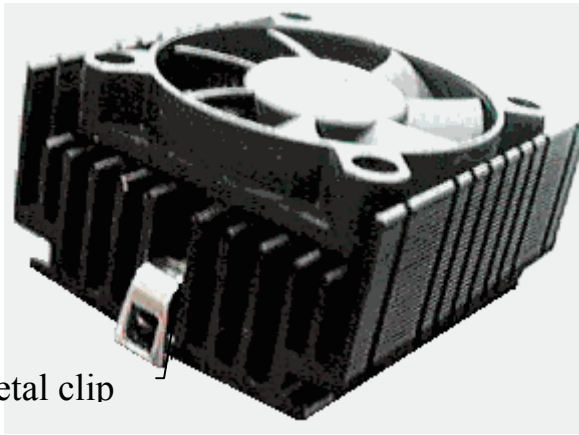

Metal clip

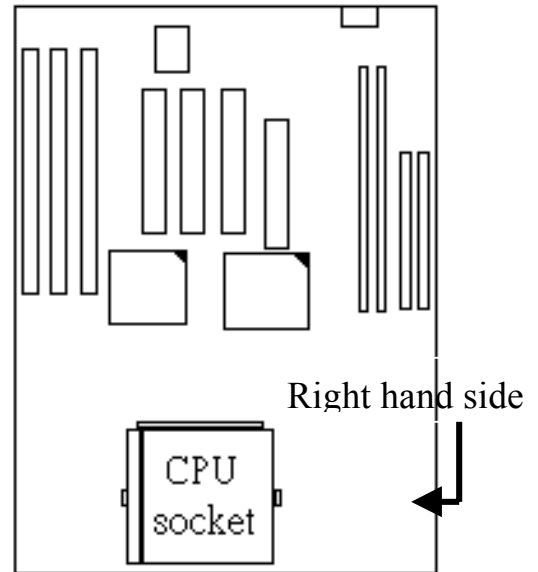

2. Place the CPU cooler squarely on the top of CPU.

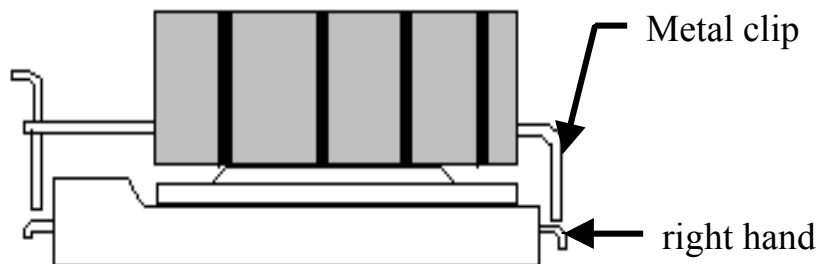

3. Hook the right hand side clip to the CPU socket first.

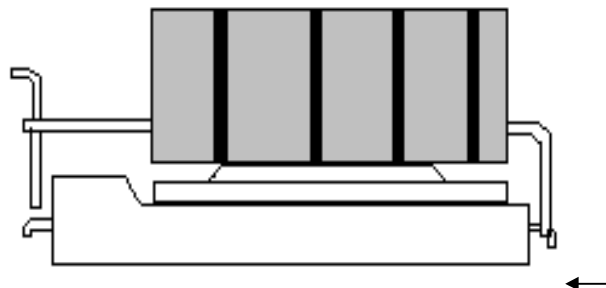

4. Push down the opposite side of the metal clip firmly and carefully to lock the cooler in place.

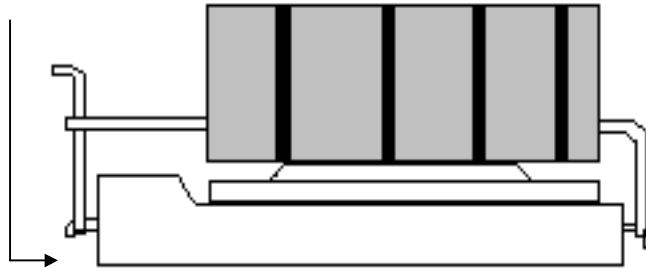

3.5 UPGRADE THE SYSTEM MEMORY

There are two 72-pin SIMM sockets (SIMM1, SIMM2) and two 168-pin DIMM sockets (DIMM1, DIMM2) on the mainboard where we can install maximum 1GB memory on the mainboard. Please refer to the following sections to see the details. Upgradable from 8MB to 256MB.

3.5.1 Installing a SIMM module

1.

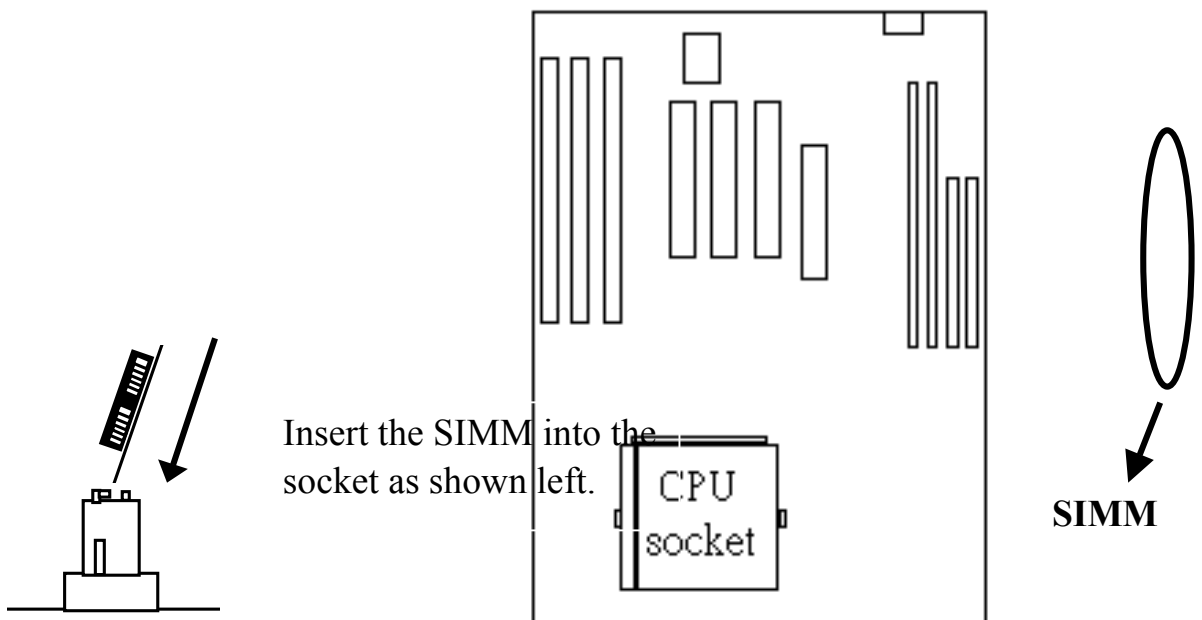

2.

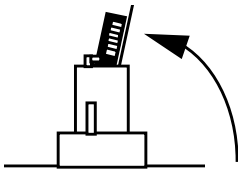

Push the SIMM module forward onto the positioning pins.

3.

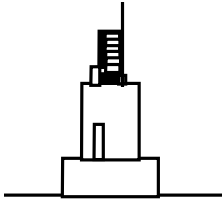

The retaining clips should fit over the edge and hold the SIMM in place.

3.5.2 Install the DIMM Module

1.

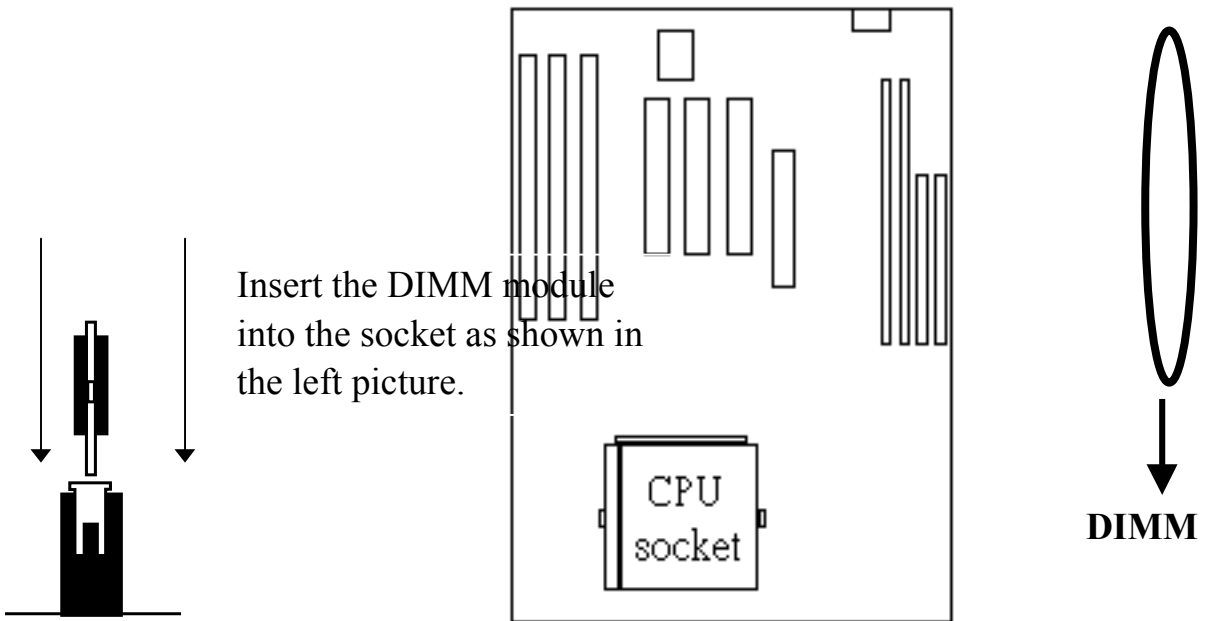

2.Extract the DIMM module from the DIMM socket.

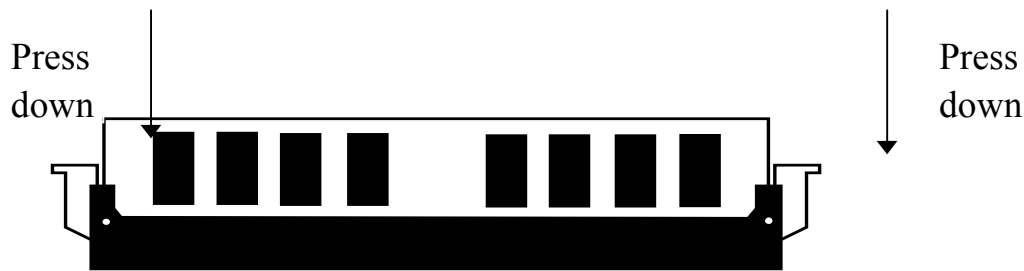

3.5.3 Suggested Memory Modules

The PT-5V3T / 5VMT system board has three banks of main memory (bank0 - 2) on board, (using two 72-pin SIMM sockets - SIMM 1-2, and two 168-pin DIMM sockets - DIMM 1-2) each bank can be single-sided or double-sided, 8MB up to 1GB of local memory can be populated on the board. Standard fast page mode (FPM), Extended Data Out (EDO) and synchronous DRAM (SDRAM) memory are all supported by this mainboard..

The suggested DRAM modules to use on this mainboard is shown as following. :

- | | | | | | |
|------------------------|---|----------|----------|---------|---------|
| (1) FPM and EDO memory | : | 512Kbx32 | (2MB), | 1Mbx32 | (4MB), |
| | | 2Mbx32 | (8MB), | 4Mbx32 | (16MB), |
| | | 8Mbx32 | (32MB), | 16Mbx32 | (64MB). |
| (2) SDRAM memory | : | 1Mbx64 | (8MB), | 2Mbx64 | (16MB), |
| | | 4Mbx64 | (32MB), | 8Mbx64 | (64MB), |
| | | 16Mbx64 | (128MB). | | |

The speed of FPM DRAMs must be 70ns or faster, the speed of EDO DRAMs and SDRAMs must be either 60ns or faster than 60ns.

The DC voltage are different on SIMM and DIMM subsystem. Please refer to the followings for the details. Please make sure to check it with your memory module before you can install it on to the mainboard.

- (1) SIMM1- SIMM2 : +5V DC
- (2) DIMM1- DIMM2 : +3.3V DC

In order to make the mainboard working, at least one bank of memory have to be installed on the board. The “BANK” is the definition of the memory subsystem addressing. Please refer to the following for the definition of “BANK”

BANK0: DIMM 1
BANK1: DIMM 2
BANK2: SIMM 1 and SIMM 2

This mainboard supports EDO, FPM and SDRAM types of memory module. When installing memory modules, you don't have to start from Bank0 first. Basically, the memory can be populated on the board in any order and the system board will detect the memory installed on the board automatically.

So you can install a DIMM module onto either Bank0 or Bank 1 first and afterward you may upgrade your system memory by plugging in another DIMM module in the DIMM socket and need not to worry about the memory type which is installed on the board.

However, when you are installing the memory modules in the SIMM sockets, you have to make sure that the module must be the same type. the reason is because SIMM1 and SIMM2 are defined as Bank 2 and the memory installed in the same bank must be the same type. So you will have to install two SIMM modules in Bank2 to make the mainboard working.

4. AWARD BIOS SETUP

4.1 GETTING STARTED

When the system is powered on or reset, the BIOS will execute the Power-On Self Test routines (POST) and checks the functionality of every component in the PC system. During the POST, you will see a copyright message on the screen followed by a diagnostics and initialization procedure. (If an EGA or VGA card is installed, the copyright message of the video card maybe displayed on the screen first.) When the system detects any error, it will gives a series of beeping sounds or display the error message on your screen.

Normally, figure 4-1 will be the screen display when the system is powered on.

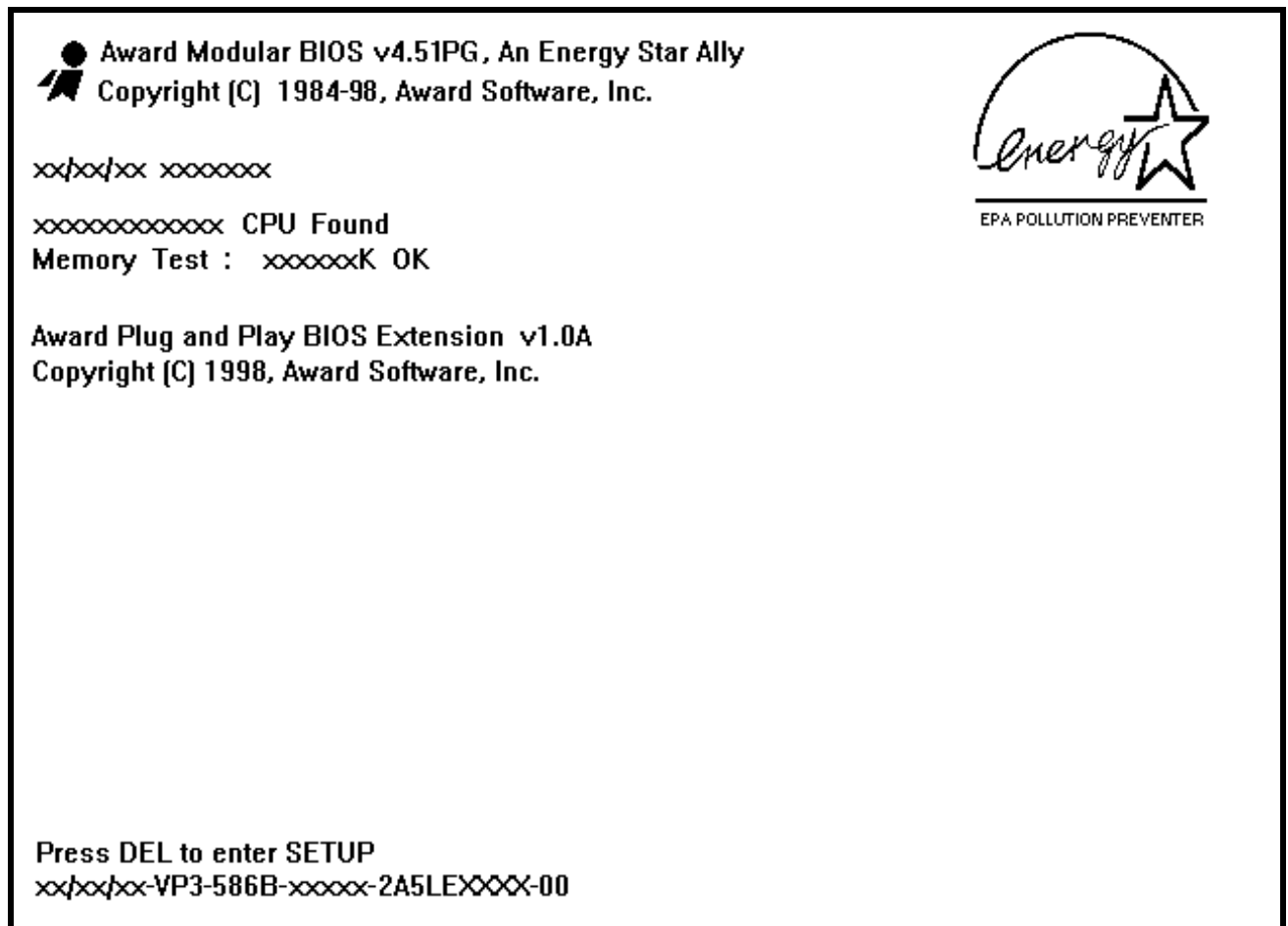

Fig. 4-1 Initial Power-On screen.

After the POST routines are completed, you will find the following message appears on the lower-left screen :

“ Press **DEL** to enter SETUP ”

To execute the Award BIOS Setup program, press the **DEL** key and the “MAIN MENU” of the BIOS setup utility as shown in Fig 4-2 will be triggered.

4.2 MAIN MENU

ROM PCI / ISA BIOS (2A5LEXXX)
CMOS SETUP UTILITY
AWARD SOFTWARE, INC.

STANDARD CMOS SETUP	
BIOS FEATURES SETUP	SUPERVISOR PASSWORD
CHIPSET FEATURES SETUP	USER PASSWORD
POWER MANAGEMENT SETUP	IDE HDD AUTO DETECTION
PNP/PCI CONFIGURATION	HDD LOW LEVEL FORMAT
INTEGRATED PERIPHERALS	SAVE & EXIT SETUP
LOAD SETUP DEFAULTS	EXIT WITHOUT SAVING
ESC : Quit	↑↓←→ : Select Item
F10 : Save & Exit Setup	(Shift) F2 : Change Color
Time, Date, Hard Disk Type ...	

Fig. 5-2 CMOS SETUP MAIN MENU screen.

4.3 CONTROL KEYS

Listed below is an explanation of the keys displayed at the bottom of the screens which will be used in the BIOS SETUP program :

- Arrow Keys** : Use the arrow keys to move the cursor to the desired item.
Enter : To select the desired item.
F1 : Display the help screen for the selected feature.
(Shift)F2 : To change the screen color, total 16 colors.
ESC : Exit to the previous screen.
PgUp(-)/PgDn(+) : To modify or change the default value of the highlighted item.
F5 : Retrieves the previous CMOS values from CMOS, (only the current page will be recovered)
F7 : Loads the SETUP default values from BIOS default table, (only the current page will be recovered)
F10 : Save all changes made to CMOS RAM in the MAIN MENU.

The following sections shows all the screens which you will find in the CMOS SETUP routine, each figure contains the setup items and its default settings. At the bottom of some figures, you may find the description of all function key which can be used to change the settings. If you are not quite sure of the definition for some specific items, please consult your mainboard supplier for details.

4.4 STANDARD CMOS SETUP

ROM PCI / ISA BIOS (2A5LEXXX)

STANDARD CMOS SETUP

AWARD SOFTWARE, INC.

Date (mm : dd : yy) Fri Feb 20 1998																			
Time (hh : mm : ss) :08 : 35 :45																			
HARD DISKS	TYPE	SIZE	CYLS	HEAD	PRECOMP	LANDZ	SECTOR	MODE											
Primary Master	Auto	0	0	0	0	0	0	0	Auto										
Primary Slave	None	0	0	0	0	0	0	0	-----										
Secondary Master	Auto	0	0	0	0	0	0	0	Auto										
Secondary Slave	None	0	0	0	0	0	0	0	-----										
Drive A : 1.44M, 3.5 in.					<table border="1"> <tr> <td>Base Memory</td> <td>: 640 K</td> </tr> <tr> <td>Extended Memory</td> <td>: xxxxxx K</td> </tr> <tr> <td>Other Memory</td> <td>: xxxxxx K</td> </tr> <tr> <td colspan="2"><hr/></td> </tr> <tr> <td>Total Memory</td> <td>: xxxxxx K</td> </tr> </table>					Base Memory	: 640 K	Extended Memory	: xxxxxx K	Other Memory	: xxxxxx K	<hr/>		Total Memory	: xxxxxx K
Base Memory	: 640 K																		
Extended Memory	: xxxxxx K																		
Other Memory	: xxxxxx K																		
<hr/>																			
Total Memory	: xxxxxx K																		
Drive B : None																			
Floppy 3 Mode Support : Disabled																			
Video : EGA/VGA																			
Halt On : All, But Keyboard																			
ESC	: Quit	↑↓←→			: Select Item	PU/PD/+/-		: Modify											
F1	: Help	(Shift)F2			: Change Color														

Fig. 4-3 STANDARD CMOS SETUP screen.

MODE:

The BIOS on the mainboard is the updated one and which provides three different modes to support both normal size IDE hard disk drive and the hard disk drive which is above 528MB:

- **NORMAL** : For IDE hard disk drives which is smaller than 528MB.
- **LBA** : For IDE hard disk drive which is above 528MB (ideally, it can be as big as 8.4GB) that use Logic Block Addressing (LBA) mode.
- **Large** : For IDE hard disks size larger then 528MB but it does not support the LBA mode.

Note: Large mode is a new technology and it is not fully supported by most operation systems so far. So only MS-DOS is recommended on such hard disk drive. Fortunately, such hard disk drive is not very common nowadays.

Note : Some certain operation system (like SCO-UNIX) will have to choose the "NORMAL" mode when installation.

4.5 BIOS FEATURES SETUP

ROM PCI / ISA BIOS (2A5LEXXX)
 BIOS FEATURES SETUP
 AWARD SOFTWARE, INC.

Virus Warning	: Disabled	Video BIOS Shadow	: Enabled
CPU Internal Cache	: Enabled	C8000-CBFFF Shadow	: Disabled
External Cache	: Enabled	CC000-CFFFF Shadow	: Disabled
Quick Power On Self Test	: Enabled	D0000-D3FFF Shadow	: Disabled
Boot Sequence	: A,C,SCSI	D4000-D7FFF Shadow	: Disabled
Swap Floppy Drive	: Disabled	D8000-DBFFF Shadow	: Disabled
Boot Up Floppy Seek	: Enabled	DC000-DFFFF Shadow	: Disabled
Boot Up NumLock Status	: On		
Gate A20 Option	: Fast		
Memory Parity/ECC Check	: Enabled		
Typematic Rate Setting	: Disabled		
Typematic Rate (Chars/Sec)	: 6		
Typematic Delay (Msec)	: 250		
Security Option	: Setup		
IDE Second Channel Control	: Enabled		
PS/2 mouse function control	: Enabled	ESC : Quit	↑↓←→ : Select Item
PCI/VGA Palette Snoop	: Disabled	F1 : Help	PU/PD/+/- : Modify
OS Select For DRAM > 64MB	: Non-OS2	F5 : Old Values (Shift)	F2 : Color
Report No FDD For WIN 95	: No	F7 : Load Setup Defaults	

Fig. 4-4 BIOS FEATURES SETUP screen.

Virus Warning : (Default values is “Disabled”)

In order to avoid virus infection happens on your PC system, PT-6IL provides the virus warning features in the BIOS. During and after the operation system is loaded, any attempt to write to the boot sector or partition table on the IDE hard disk drive will trigger this feature and give you some warning messages on the screen and then halt the system. When you find the message on your screen, please run an anti-virus program to

see whether your system is infected by a virus or not.

Enabled : Activate automatically when the system boots up causing a warning message to appear on the screen when anything attempts to access the boot sector of the hard disk partition table.

Disabled : No warning message to appear when anything attempts to access the boot sector or hard disk partition table.

CPU Internal Cache :

This option enables CPU's internal (L1) cache memory. If you want to use the internal (L1) cache memory and external (L2) cache memory, you may use this option to enable or disable the setting.

External Cache :

This option enables L2 (secondary) external cache memory. If there is no external cache memory on board you have to select "disabled",

4.6 CHIPSET FEATURES SETUP

ROM PCI / ISA BIOS (2A5LEXXX)
CMOS SETUP UTILITY
CHIPSET FEATURES SETUP

Bank 0/1 DRAM Timing	: 70 ns	OnChip USB	: Disabled
Bank 2/3 DRAM Timing	: 70 ns	USB Keyboard Support	: Disabled
Bank 4/5 DRAM Timing	: 70 ns	Auto Detect DIMM/PCI CLK	: Enabled
SDRAM Cycle Length	: 3	Spread Spectrum	: Disabled
SDRAM Bank Interleave	: Disabled	<i>CPU Warning Temperature</i>	: <i>Disabled</i>
DRAM Page-Mode	: Disabled	<i>Current CPU Temperature</i>	: <i>31 °C/87 °F</i>
DRAM Read Pipeline	: Disabled	<i>Current CPUFAN1 Speed</i>	: <i>0 RPM</i>
Sustained 3T Write	: Enabled	<i>Current CPUFAN2 Speed</i>	: <i>0 RPM</i>
Cache Rd+CPU Wt Pipeline	: Disabled	<i>Current Vin(V)</i>	: <i>3.3V</i>
Read Around write	: Enabled	(see note)	
Cache Timing	: Fast		
Video BIOS Cacheable	: Disabled		
System BIOS Cacheable	: Disabled		
Memory Hole At 15Mb Addr.	: Disabled		
AGP Aperture Size	: 256M		
		ESC : Quit	↑↓←→ : Select Item
		F1 : Help	PU/PD/+/- : Modify
		F5 : Old Values (Shift)F2	: Color
		F7 : Load Setup Defaults	

Fig. 4-5 CHIPSET FEATURES SETUP screen.

NOTE: The setting items that are written in *italic-font* on this screen will appear only when U17 (GL518SM, Hardware Monitoring Device) is present on board, otherwise, you will unable to see these items on the above screen.

WARNING : The selection fields on this screen are provided for the professional technician who can modify the Chipset features to meet some specific requirement. If you do not have the related technical background, do not attempt to make any change except the following items.

Bank 0/1 (2/3, 4/5)DRAM Timing :

There are two optimum values suggested for the chipset and CPU registers. You may select either “60 ns” or “70 ns” according to the different DRAMs‘ which is installed on the board,. Basically, “60 ns” will let you have better performance. However, “70ns” is recommended in most case causes it works with most DRAM modules

4.7 POWER MANAGEMENT SETUP

ROM PCI / ISA BIOS (2A5LEXXX)

POWER MANAGEMENT SETUP

AWARD SOFTWARE, INC.

Power Management	: User Define	Primary INTR	: ON
PM Control by APM	: Yes	IRQ3 (COM 2)	: Primary
Video Off Option	: Suspend->Off	IRQ4 (COM 1)	: Primary
Video Off Method	: Blank Screen	IRQ5 (LPT2)	: Primary
MODEM Use IRQ	: 3	IRQ6 (Floppy Disk)	: Primary
Soft-Off by PWRBTN	: Delay 4 Sec.	IRQ7 (LPT1)	: Primary
** PM Timers **		IRQ8 (RTC Redir)	: Disabled
HDD Power Down	: Disabled	IRQ9 (IRQ2 Redir)	: Secondary
Doze Mode	: Disabled	IRQ10 (Reserved)	: Secondary
Suspend Mode	: Disabled	IRQ11 (Reserved)	: Secondary
** PM Events **		IRQ12 (PS/2 Mouse)	: Primary
VGA	: OFF	IRQ13 (Coprocessor)	: Primary
LPT & COM	: LPT/COM	IRQ14 (Hard Disk)	: Primary
HDD & FDD	: ON	IRQ15 (Reserved)	: Disabled
DMA/master	: OFF		
Modem Ring Resume	: Disabled	ESC : Quit	↑↓←→ : Select Item
RTC Alarm Resume	: Disabled	F1 : Help	PU/PD/+/- : Modify
		F5 : Old Values	(Shift)F2 : Color
		F7 : Load Setup Defaults	

Fig. 4-6 POWER MANAGEMENT SETUP screen.

WARNING : The selection fields on this screen are provided for the professional technician who can modify the Chipset features to meet some specific requirement. If you do not have the related technical background, do not attempt to make any change except the following items.

Power management :

This setting controls the Power Management functions. “User Define” will allow user to define his own parameters. “Min Saving” and “Max Saving” is a quick selection option which will fix the values of four parameters, including “Doze Mode”, “Standby Mode”, “Suspend Mode” and “HDD Power Down”. When “Disable” is selected, it will disable all Power Management functions.

4.8 PNP/PCI CONFIGURATION

ROM PCI / ISA BIOS (2A5LEXXX)

PNP/PCI CONFIGURATION

AWARD SOFTWARE, INC.

PNP OS Installed	: Yes	CPU to PCI Write Buffer	: Enabled
Resources Controlled By	: Manual	PCI Dynamic Bursting	: Enabled
Reset Configuration Data	: Disabled	PCI Master 0 WS Write	: Enabled
ACPI I/O Device Node	: Enabled	PCI Delay Transaction	: Disabled
IRQ-3 assigned to	: Legacy ISA	PCI Master Read Prefetch	: Enabled
IRQ-4 assigned to	: Legacy ISA	PCI #2 Access #1 Retry	: Disabled
IRQ-5 assigned to	: PCI/ISA PnP	AGP Master 1WS Write	: Enabled
IRQ-7 assigned to	: Legacy ISA	AGP Master 1 WS Read	: Disabled
IRQ-9 assigned to	: PCI/ISA PnP	PCI IRQ Actived By	: Level
IRQ-10 assigned to	: PCI/ISA PnP	Assign IRQ For USB	: Enabled
IRQ-11 assigned to	: PCI/ISA PnP	Assign IRQ For VGA	: Enabled
IRQ-12 assigned to	: Legacy ISA		
IRQ-14 assigned to	: Legacy ISA		
IRQ-15 assigned to	: Legacy ISA		
DMA-0 assigned to	: PCI/ISA PnP		
DMA-1 assigned to	: PCI/ISA PnP	ESC : Quit	↑↓←→ : Select Item
DMA-3 assigned to	: PCI/ISA PnP	F1 : Help	PU/PD/+/- : Modify
DMA-5 assigned to	: PCI/ISA PnP	F5 : Old Values	(Shift)F2 : Color
DMA-6 assigned to	: PCI/ISA PnP	F7 : Load Setup Defaults	
DMA-7 assigned to	: PCI/ISA PnP		

Fig. 4-7 PNP/PCI CONFIGURATION setup screen.

WARNING : The selection fields on this screen are provided for the professional technician who can modify the Chipset features to meet some specific requirement. If you do not have the related technical background, do not attempt to make any change except the following items.

Resources Controlled by :

Manual : The system BIOS will not refer to the ESCD data to assign IRQ & DMA.

Instead, it will refer to the information recorded in this field when assigning the IRQ & DMA resource. (anyhow, the system BIOS will always refer to the ESCE data to assign the I/O and memory space resources).

Auto : The system BIOS will refer to the ESCD segment for all legacy information.

Reset Configuration Data :

Disabled : The system BIOS will do nothing.

Enabled : The system BIOS will clear/reset the ESCD during “POST”. After clearing the ESCD, the system BIOS will then change this item’s value back to “Disable”, otherwise, the ESCD will become useless.

There are only 15 IRQs and 8 DMAs available on the mainboard and most of them are assigned for some specific purposes. Sometimes, user may feel like to have some more IRQ and DMA in order to install the new add on cards. In this case, you may use this field to assign some certain IRQ and DMA to “PCI/ISA PnP” so that the new add on card will find the free IRQ or DMA available for it.

Legacy : The system BIOS will skip and never assign the specified IRQ/DMA ISA resource to PCI or ISA PnP devices and the IRQ and DMA can only be used by their specified Legacy ISA cards.

PCI/ISA: PnP : When the “PCI/ISA PnP” is been selected, the related IRQ and DMA will be released and they can be used by other PCI or ISA devices. Whenever there is the new PCI or ISA devices plugged onto the mainboard, the system BIOS will detect it and assign a free IRQ or DMA for the new devices.

.Note: Most IRQ and DMA have its own purpose and they can not be assigned to “PCI/ISA PnP”. For example, IRQ14 and IRQ15 is used by the onboard IDE device. If you change the setting on IRQ14 and IRQ15, you will be unable to connect the hard disk drive or CD ROM drive to the IDE interface on the mainboard. So please make sure to check the IRQ and DMA assignment in your system before you proceed to do the setting. For instance, if you do not have the printer (IRQ7) or PS/2™ mouse (IRQ12) connected to your PC system, you may assign IRQ7 and IRQ12 to “PCI/ISA PnP” so that you can have more IRQs available for new add on cards.

Explanation for technical issues :**PnP device :**

- Device that has Plug & Play compatibility. That means it will request for DMA, IRQ, I/O and Memory from the PnP BIOS and all these requests can be relocatable. In other words, these devices do not utilize any fixed resources.
- All PCI devices and all ISA PnP devices are PnP devices.

Legacy device :

- A legacy device is a device that all its resources are fixed by hardware (or selected by jumpers).
- All ISA Non-PnP devices are legacy device.

Extended System Configuration Data (ESCD) :

- A media between the user and the system BIOS for passing the legacy devices information's. This information is stored in the onboard NVRAM (flash ROM).

4.9 INTEGRATED PERIPHERALS

ROM PCI/ISA BIOS (2A5LEXXX)
INTEGRATED PERIPHERALS
AWARD SOFTWARE, INC.

On-Chip IDE First Channel	: Enabled	Onboard Parallel Port	: 378 / IRQ 7
On-Chip IDE Second Channel	: Enabled	Parallel Port Mode	: SPP
IDE Prefetch Mode	: Disabled		
IDE HDD Block Mode	: Enabled		
IDE Primary Master PIO	: Auto		
IDE Primary Slave PIO	: Auto		
IDE Secondary Master PIO	: Auto		
IDE Secondary Slave PIO	: Auto		
IDE Primary Master UDMA	: Auto		
IDE Primary Slave UDMA	: Auto		
IDE Secondary Master UDMA	: Auto		
IDE Secondary Slave UDMA	: Auto		
Onboard FDC Controller	: Enabled		
Onboard Serial Port 1	: 3F8 / IRQ 4		
Onboard Serial Port 2	: 2F8 / IRQ 3	ESC : Quit	↑↓←→ : Select Item
UART 2 Mode	: Standard	F1 : Help	PU/PD/+/- : Modify
		F5 : Old Values	(Shift)F2 : Color
		F7 : Load Setup Defaults	

Fig. 4-8 INTEGRATED PERIPHERALS setup screen.

WARNING : The selection fields on this screen are provided for the professional technician who can modify the Chipset features to meet some specific requirement. If you do not have the related technical background, do not attempt to make any change except the following items.

UART 2 Mode :

This setting determines the IR port (CN6) function mode. Supports both HPSIR and ASKIR.

Onboard Parallel Mode :

This setting determines the onboard parallel port (CN8) transmission mode. Supports either SPP, EPP, ECP, or ECP+EPP.

4.10 LOAD SETUP DEFAULTS

If you lost the CMOS data or you don't know how to complete the setup procedure, you may use this option to load the SETUP default values from the BIOS default table. It is easy to load the default value, simply highlight the "LOAD SETUP DEFAULTS" field and then press the "Enter" key, when you see the "LOAD SETUP DEFAULTS (Y/N)" displayed on the screen, response to it with "Y" and then press the "Enter" key. the SETUP default values will be loaded. Basically, the SETUP default settings are the best-case values that will optimize system performance and increase system stability.

In case that the CMOS data is corrupted, the SETUP DEFAULTS settings will be loaded automatically when you press the "Del" key and enter the main setup screen. So you may select "SAVE & EXIT SETUP" to leave setup program and the system is loaded with the default settings.

4.11 SUPERVISOR PASSWORD / USER PASSWORD

The "SUPERVISOR PASSWORD" and "USER PASSWORD" will be used to check the authority when power-on. Whenever there is the password stored in either of these fields, the correct password will be requested so that the PC system will continue to load the operation system.

You can enter up to eight alphanumeric characters here. When you have typed in the password and pressed the "Enter" key, you will be asked to reconfirm your password again to complete password setup. If you press the "Enter" key twice without any alphanumeric character entered, the PASSWORD will be disabled.

If the "User Password" and the "Supervisor Password" are both enabled and they have different password setup, "Supervisor Password" is always has the higher priority, Basically, an "User" is only authorized to change the content of "User Password", while a "Supervisor" has the authorization to dominate all settings.

4.12 IDE HDD AUTO DETECTION

In order to make the IDE hard disk known to the system, you need to tell the system what kind of hard disk is connected to the mainboard by giving a set of hard disk parameters. Sometimes it is not easy for users to find the proper parameters for their IDE hard disk drive. In order to help users to find the parameters, the system BIOS provides a convent way – the auto detection of IDE hard disk drive.

To run the auto detection program is extremely easy. Move the selection bar to “IDE HDD AUTO DETECTION” and then press “Enter”, the system BIOS take over the job and try to detect the type of IDE hard disk. If it succeeds, you will see a list of hard disk with its related parameters. You may press on the “Y” key (or select one of the hard disk type listed on the screen). The system BIOS will transfer the parameters to the corresponding fields in the STANDARD CMOS SETUP menu and you have completed the IDE hard disk setup.

4.13 HDD LOW LEVEL FORMAT

This option provides an utility program for IDE HDD Low Level Format. Performing the Hard Disk low lever Format will destroy any data on the Hard Disk. Please make sure to back up the Hard Disk(s) before actually performing of these routines.

*Note : These routines are not valid for a **SCSI** Disk Drive.*

4.14 SAVE &EXIT SETUP

This option will save all setup values to CMOS RAM & EXIT SETUP routine, by moving the selection bar to “SAVE & EXIT SETUP” and pressing “Enter” key, then types “Y” and “Enter” key, the values will be saved and all the information will be stored in the CMOS memory, and then the setup program will be terminated and the system will start to reboot.

4.15 EXIT WITHOUT SAVING

This item exit the setup routine without saving any changed values to CMOS RAM, When you do not want to save your change to the CMOS memory, you may choose to run this option and the setting what you made in the BIOS setup routine will be given away.

Move the selection bar to “EXIT WITHOUT SAVING” and click on the “Enter” key, then you will be asked to confirm the action to exit, press the “Y” and “Enter” key, the setup program will be terminated and the system will start to reboot.

Printed in Taiwan
Edition : 02 / 20 / 98