

P4X4-ALH Mainboard Manual

Socket 478 DDR333 ATX Mainboard

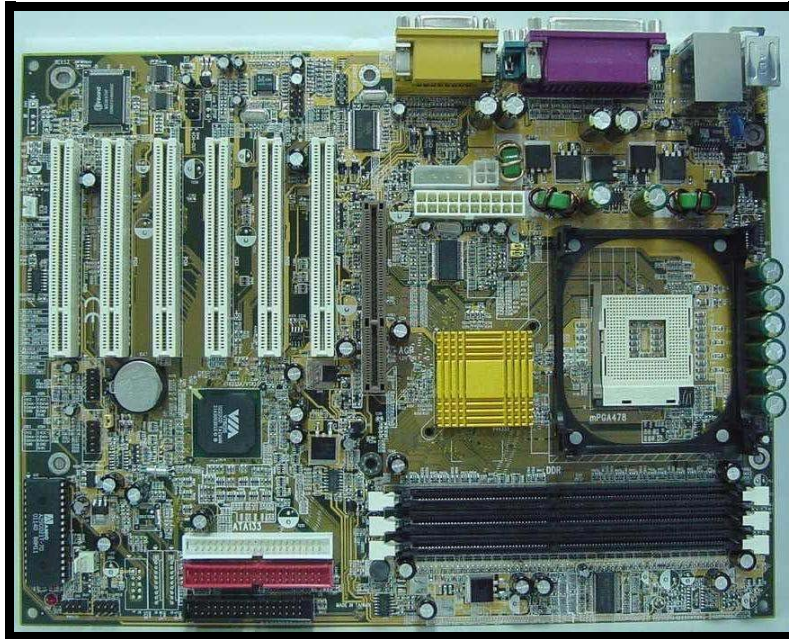

Version 1.x
UM-P4X4-ALH-E1
Rev 1.0V
Creation Date: 02 August 2002

User's Notice

Copyright

This publication contains information that is protected by copyright. No part of it may be reproduced in any form or by any means or used to make any transformation adaptation without prior written permission from the copyright holders. This publication is provided for informational purposes only. The manufacturer makes no representations or warranties with respect to the contents or use of this manual and specifically disclaims any express or implied warranties of merchantability or fitness for any particular purpose. The user will assume the entire risk of the use or the results of the use of this document. The manufacturer reserves the right to revise this publication and make changes to its contents at any time, without prior notice.
2002. All Rights Reserved.

Trademarks

Microsoft®, MS-DOS®, Windows™, Windows®95 and Windows®98 are registered trademarks of Microsoft Corporation. Intel® Pentium™4 is a registered trademark of Intel Corporation. Award is the registered trademark of Award Software, Inc. Other trademarks and registered trademarks of products appearing in this publication are the properties of their respective holders.

Package Checklist

This package contains the following items:

- Mainboard
- User's manual
- One IDE cable
- One 34-pin floppy disk drive cable
- One 4 CH out cable
- One Driver Utility CD

If any of these items are damaged or missing, please contact your dealer or sales representative for assistance.

Technical Support

If you require additional information or assistance during installation please contact your dealer. Your dealer will be able to provide the latest information.

Table Of Contents

Chapter 1:- Introduction *Page 5*

1.1. Mainboard and PC 99 ATX External Connector Layout	5
1.2. Overview	6
1.2.1. The P4X4-ALH Mainboard	6
1.2.2. Mainboard Dimensions	6
1.2.3. Environmental Limitations	6
1.3. Features and Specifications	6
1.4. System Health Monitor Functions	9
1.5. System Intelligence	9

Chapter 2:- Hardware Installation *Page 10*

2.1. Installation Checklist	10
2.2. Installation Steps	11
2.3. Expansion Slots, Jumpers and Internal Connectors	12
2.4. CPU, Memory and Expansion Slots	13
2.4.1. Installation of the CPU	13
2.4.2. Memory Modules	13
2.4.3. PCI Slots	14
2.4.4. AGP (Accelerated Graphics Port) Slot	14
2.5. Internal Connectors	15
2.5.1. Floppy Disk Drive Connector	15
2.5.2. Primary and Secondary IDE Connectors	15
2.5.3. Infrared Connector (Optional)	15
2.5.4. CPU Fan and Chassis Fan Connectors	16
2.5.5. ATX Power Supply Connectors	16
2.5.6. CD-IN/AUX-IN Connector	17
2.5.7. WOL (Wake-On-LAN) Connector	17
2.5.8. S/PDIF Connector (Optional)	17
2.5.9. USB3, USB4, USB5, USB6 Connectors	18
2.5.10. Front Audio Connector	18
2.5.11. 4 CH OUT	19
2.6. System Panel Buttons and LED Connectors	20
2.6.1. PW: Power On / Off and External Suspend Switch Connector	20
2.6.2. SL: Sleep LED Connector	20
2.6.3. HL: IDE HDD LED Connector	20
2.6.4. RS: Reset Button Connector	20
2.7. Speaker and Power LED Connectors	21
2.7.1. Speaker Connector	21
2.7.2. Front Panel Power LED	21

Table Of Contents

2.8. External Connectors	21
2.8.1. PS/2 Keyboard Connector	21
2.8.2. PS/2 Mouse Connector	21
2.8.3. Serial Port Connectors	21
2.8.4. Parallel Port Connector	22
2.8.5. Universal Serial Bus (USB) Ports.....	22
2.8.6. Audio/Game Connector	22
2.8.7. RJ-45 (LAN Port) Connector	22
2.9. Jumper Settings	23
2.9.1. JP1: Keyboard Power	23
2.9.2. JP3: USB 1, 2 Power	23
2.9.3. JP5: CPU Clock	23
2.9.4. JP8: Check 1.5V AGP	24
2.9.5. JP9: Clears CMOS	24

Chapter 3:- Managing The PC BIOS *Page 24*

3.1. Award BIOS CMOS Setup Utility	25
3.2. Main Menu	25
3.3. Standard CMOS Setup	26
3.4. Advanced BIOS Features	28
3.5. Advanced Chipset Features	31
3.6. Integrated Peripherals	34
3.7. Power Management Setup	38
3.8. PNP/PCI Configuration	41
3.9. PC Health Status	42
3.10. Frequency/Voltage Control	43
3.11. Load Fail-Safe Defaults / Load Optimized Defaults	44
3.11.1. Load Fail-Safe Defaults.....	44
3.11.2. Load Optimized Defaults.....	44
3.12. Set Supervisor Password and User Password	45
3.12.1. Set Supervisor Password.....	45
3.12.2. Set User Password	45
3.13. Save & Exit Setup/Exit Without Saving	46
3.13.1. Save & Exit Setup	46
3.13.2. Exit Without Saving	46

Introduction

Chapter 1 - Introduction

1.1. Mainboard and PC 99 ATX External Connector Layout

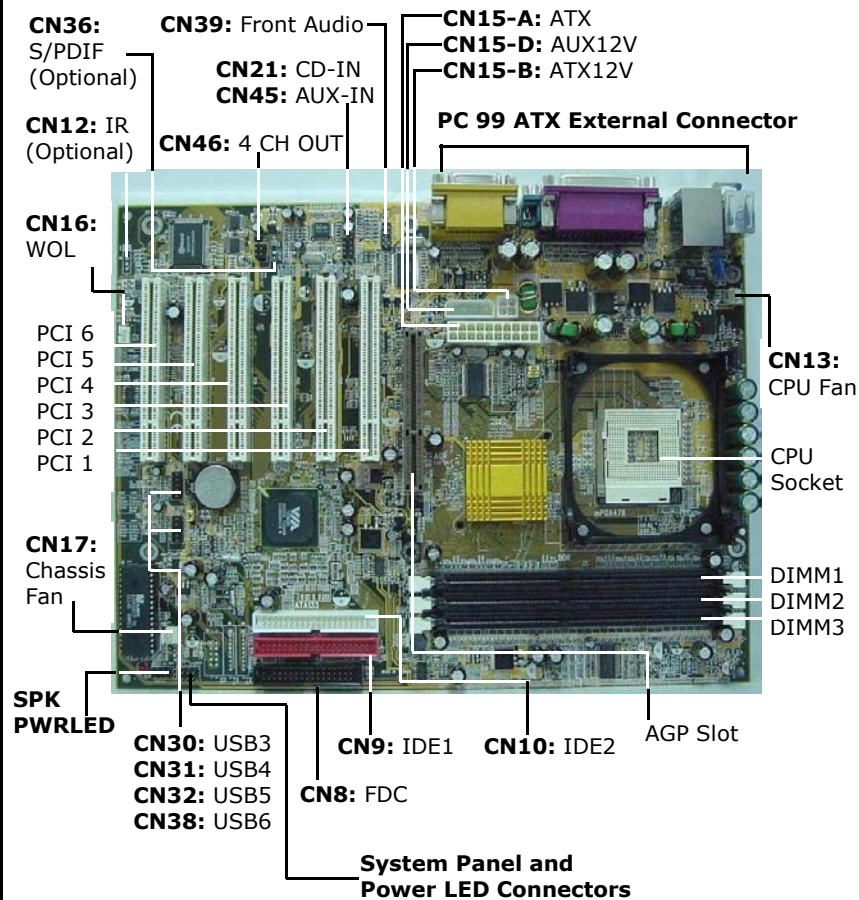

Introduction

PC 99 ATX External Connector

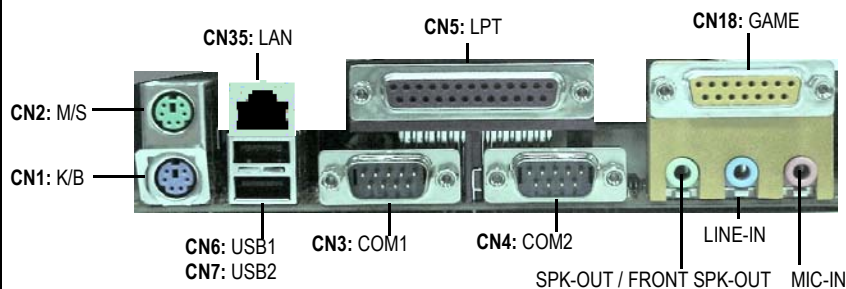

1.2. Overview

1.2.1. The P4X4-ALH Mainboard

The **P4X4-ALH** mainboard is a **Pentium™ 4** DDR platform. Onboard it provides three DDR DIMM slots (support up to DDR333), six USB2.0 ports, six PCI slots and one 1.5V 4X/8X AGP slot. There are also two fan connectors (for additional thermal protection) and three power supply connectors. Additionally, it comes with Onboard Audio (AC'97 6-channel), Onboard LAN [VIA VT6103 (PHY)] and WOL (Wake-On-LAN) connector that enables it to be "woken up" from a soft-off power state when it receives a signal from the LAN. Other on-board connectors include CD-IN, AUX-IN and Front Audio connectors etc.

1.2.2. Mainboard Dimensions

Width	305 mm
Length	230 mm

1.2.3. Environmental Limitations

Operating Temperature:	10°C to 40°C (50°F to 104°F)
Required Airflow:	50 linear feet per minute across the CPU
Storage Temperature:	-40°C to 70°C (-40°F to 158°F)
Humidity:	0 to 90% non-condensing
Altitude:	0 to 10 000 feet

1.3. Features and Specifications

Processor

The **P4X4-ALH** mainboard supports **Intel® Pentium™ 4 Socket 478** CPUs.

Chipsets

Northbridge	Southbridge	I/O Chipset
VIA P4X400	VIA VT8235 (CD)	Winbond W83697HF

Introduction

CPU Switching Voltage Regulator

The mainboard is equipped with a switching voltage regulator that automatically detects a DC power supply from +1.10V to +1.85V.

System Memory

The mainboard uses Double Data Rate Dual Inline Memory Modules (DDR DIMM). Each mainboard has **three** 184-pin DIMM sockets which support 2.5V (power level) single-sided or double sided PC1600 (DDR200), PC2100 (DDR266) or PC2700 (DDR333) DDR DIMM modules. The maximum memory supported by the mainboard is 3 GB.

Expansion Slots

The mainboard is equipped with **six** dedicated PCI slots and **one** 1.5V 4X/8X AGP slot.

Onboard Audio Features

The mainboard supports Microsoft DirectSound/DirectSound 3D and AC97 Full Duplex.

Onboard LAN Features

The mainboard comes with Onboard LAN [VIA VT6103 (PHY)].

WOL (Wake-On-LAN) Port

The mainboard supports Wake-On-LAN functionality.

Word Size

Data Path: 8-bit, 16-bit, 32-bit, 64-bit
Address Path: 32-bit

Front Side Bus Frequency (FSB)

The Front Side Bus Frequency (FSB) clock is 400/533 MHz.

BIOS

- Award BIOS, Windows 95/98 Plug and Play (PnP) compatible
- Supports SCSI sequential boot-up
- 2 Mb flash ROM for easy BIOS upgrades
- Supports DMI2.0 function

Desktop Management Interface (DMI)

The mainboard comes with DMI 2.0 built into the BIOS. The DMI utility in the BIOS will automatically record different information about your system configuration and store this information in the DMI pool, which is a part of the system board's Plug and Play BIOS. DMI, along with the appropriately networked software, is designed for easy inventory, maintenance and the simplified troubleshooting of computer systems.

Introduction

USB2.0 Ports

USB allows data exchange between your computer and a wide range of simultaneously accessible external Plug and Play peripherals. The mainboard is equipped with **six** USB (version 2.0) connectors. USB1 and USB2 are external connectors. They can be found on the PC 99 ATX connector. The other USB connectors are internal connectors and can be used to connect other USB devices. (Cables for the internal connectors are sold separately).

Please note that the PIN assignment of the internal USB 2.0 connectors (CN30, CN31, CN32 and CN38) are follow the specifications of Intel standard.

Connectors

- Two IDE connectors (support ATA 33/66/100/133)
- One Floppy Drive connector supports up to two 2.88 MB floppy drives
- One 20-pin ATX power supply connector
- One 2x2 ATX 12V power supply connector
- One 1x4 AUX12V power supply connector
- Two fan connectors
- One CD-IN connector
- One AUX-IN connector
- One WOL (Wake-On-LAN) connector
- One Front Audio connector
- One 4-Channel out connector
- One S/PDIF connector (optional)
- One IR connector (optional)

ATX Double Deck Ports (PC 99 color-coded connectors)

- Two USB2.0 ports
- Two external DB-9 serial port connectors: COM 1, COM 2 (UART)
- One SPP/ECP/EPP DB-25 parallel port
- One mini-DIN-6 PS/2 mouse port
- One mini-DIN-6 PS/2 keyboard port
- One GAME port
- One LAN port (RJ-45) connector
- Three audio jacks: SPK-OUT/FRONT SPK-OUT, LINE-IN and MIC-IN

PCI Bus Master IDE Controller

- Two PCI IDE interfaces support up to four IDE devices.
- This mainboard supports ATA 33/66/100/133 hard drives.
- PIO Mode 3 and Mode 4 Enhanced IDE (data transfer rate up to 16.6MB/sec.).
- Bus mastering reduces CPU utilization during disk transfer.
- Supports ATAPI CD-ROM, LS-120 and ZIP.

Introduction

1.4. System Health Monitor Functions

The mainboard is capable of monitoring the following health conditions of your system:

1. Processor temperature. It has an overheat alarm.
2. VCORE/3.3V/5V/12V/-12V voltages and failure alarm.
3. Processor and chassis fan speeds. It has a failure alarm for these fans.
4. Read back capability that displays temperature, voltage and fan speed.

Hardware Monitoring System Utility

The mainboard comes with the Hardware Monitoring System utility contained on the CD. It is capable of monitoring the system's hardware conditions such as the temperature of the processor, voltage, and the speed of both the CPU and chassis fans. You are allowed to manually set a range to the items being monitored. If the values are over or under the set range a warning message will automatically pop up. We recommend that you use the Default Settings, which are the ideal settings that will maintain the system in a good working condition. To install this utility, please insert the CD into the CD-ROM drive. The auto run screen (Driver Utility) will automatically appear. Click the Hardware Monitoring button, choose the chipset, model number and the OS that is installed. Please refer to the CD "Readme" file for further installation instructions.

Note: Only use this utility in Windows operating systems.

1.5. System Intelligence

Dual Function Power Button

Depending on the setting in the Soft-Off By Power-Button field of the Power Management Setup, this switch allows the system to enter the Soft-Off or Suspend mode.

RTC Timer to Power-on the System

The RTC installed on the system board allows your system to automatically power-on at a set date and time.

Wake-On-LAN Ready

The Wake-On-LAN function allows the network to remotely wake up a Soft Power Down (Soft-Off) PC. Your LAN card must support the remote wakeup function. The 5V SB power source of your power supply must be at least 720mA.

ACPI Ready

The mainboard is designed to meet the ACPI (Advanced Configuration and Power Interface) specification. ACPI has energy saving features that support OS Direct Power Management (OSPM) for round the clock PC operation.

Hardware Installation

Chapter 2 - Hardware Installation

2.1. Installation Checklist

The following is a checklist of all the expansion slots, jumpers and connectors that should be configured on your mainboard before you can run your PC.

Installation Checklist		
Expansion Slots and Sockets		
CPU Socket	Intel® Pentium™ 4 Socket 478 CPU	
DIMM Slots	Three 184-pin Slots	
PCI Slots	Six 32-bit PCI Slots	
AGP Slot	One 1.5V 4X/8X Accelerated Graphics Port Slot	
Internal Connectors		
CN8	Floppy Drive Connector	FDC
CN9	Primary IDE	IDE1
CN10	Secondary IDE	IDE2
CN12	Infrared	IR (optional)
CN13	CPU Fan	CPU Fan
CN15-A	ATX Power Supply	ATX
CN15-B	ATX 12V Power Supply	ATX12V
CN15-D	Auxiliary ATX 12V Power Supply	AUX12V
CN16	Wake-On-LAN Connector	WOL
CN17	Chassis Fan	FAN2
CN21	CD Audio In	CD-IN
CN30/31	Universal Serial Bus 3/4	USB3/4
CN32/38	Universal Serial Bus 5/6	USB5/6
CN36	Sony Phillips Digital Interface	S/PDIF (optional)
CN39	Front Audio Connector	Front Audio
CN45	Auxiliary In Connector	AUX-IN
CN46	4 CH OUT	4-Channel Audio Out
External Connectors		
CN1	PS/2 Keyboard Connector	K/B
CN2	PS/2 Mouse Connector	M/S
CN3	Serial Port 1	COM1
CN4	Serial Port 2	COM2

"Optional": These are manufacturing options.

Hardware Installation

Installation Checklist (Continued)

CN5	Parallel Port	LPT
CN6	Universal Serial Port 1	USB1
CN7	Universal Serial Port 2	USB2
CN18	Audio/GAME Port	AUDIO/GAME
CN35	RJ-45 (LAN) Connector	LAN

Speaker and Power LED Connectors

PW	Power On/Off and Suspend Switch Connector
SL	Standby LED Connector
HL	HDD LED Connector
RS	Reset Button Connector

Speaker and Power LED Connectors

PWRLED	Power LED
SPK	Speaker Connector

Jumpers and Switches

JP1	K/B Power
JP3	USB1,2 Power
JP5	CPU Clock
JP8	Check 1.5V AGP (optional)
JP9	Clear CMOS

2.2. Installation Steps

You need to complete the following installation steps before you can use your PC.

- Check and set the mainboard settings;
- Install the Central Processing Unit (CPU);
- Install the memory modules;
- Install the expansion cards;
- Connect the ribbon cables, panel wires and power supply;
- Setup the system BIOS.

Before you start installing your mainboard we strongly recommend that you use a grounded anti-static mat. We further recommend that you attach an anti-static wristband, which is grounded at the same location as the mat, to your wrist.

Hardware Installation

2.3. Expansion Slots, Jumpers and Internal Connectors

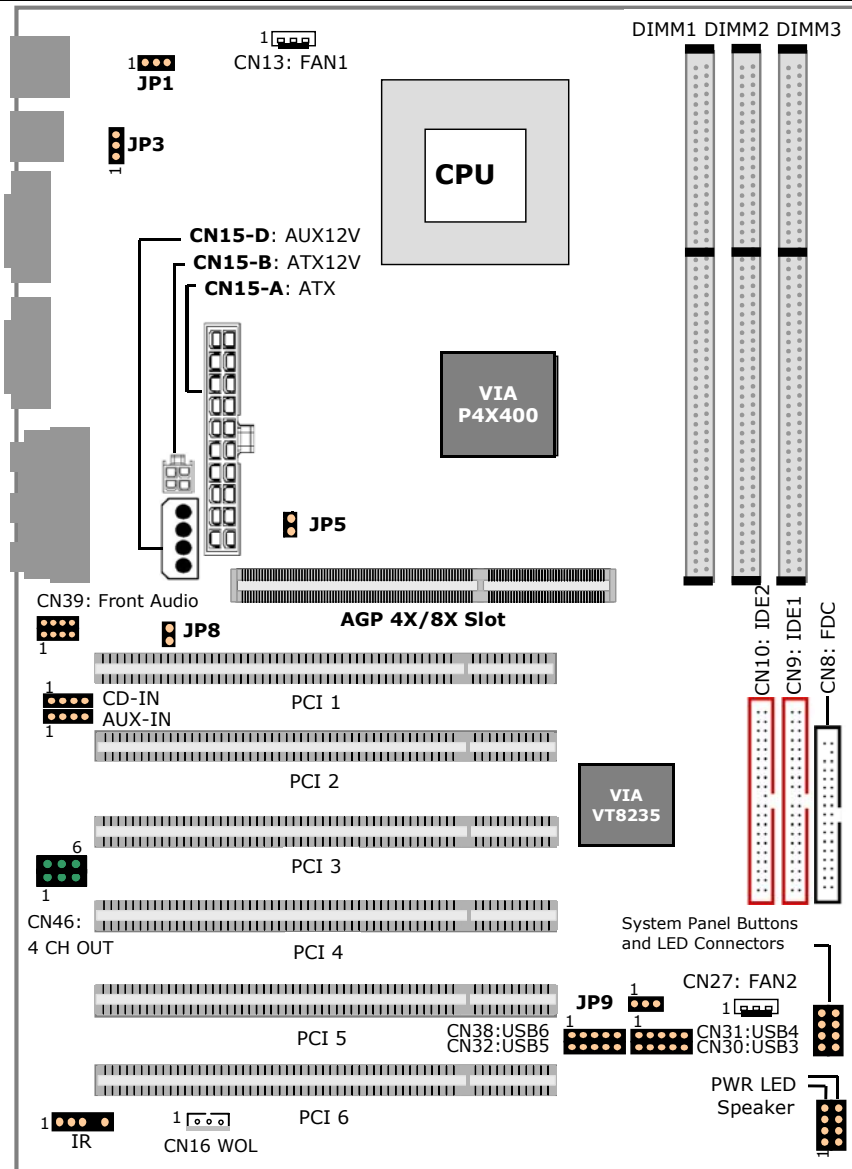

Hardware Installation

2.4. CPU, Memory and Expansion Slots

2.4.1. Installation of the CPU

To install your processor, please complete the following set of instructions:

1. Locate a small dot marked on the top of the CPU. This mark indicates Pin of the CPU.
2. Locate Pin 1 for the Socket on the mainboard.
3. There is a lever on the side of the socket. First push this lever sideways and then lift it to a 90-degree angle.
4. Insert the CPU into the Socket. Please make sure that Pin 1 for the CPU is inserted into Pin 1 of the Socket.
5. When the CPU is installed correctly push the lever back into place.
6. **Install a proper heat sink with cooling fan** for proper heat dissipation. Failing to install a heat sink with cooling fan may cause overheating which will burnout your CPU and damage your mainboard.

IMPORTANT: CPU COOLING FAN

Please ensure that you have an approved heat sink with cooling fan. Without a proper heat sink with cooling fan you will damage both the mainboard and the CPU.

2.4.2. Memory Modules

The mainboard has **three** 184-pin DDR DIMM slots which are located on the right-hand side of the board. To install the DIMM's into these slots, make sure the white lever at each side of the slot has been pulled down to an angle of approximately 45°. Make sure that the DIMM is in the correct orientation. Place the DIMM on the slot and push down firmly. The white levers will come back up and lock the module in place.

Supports 128 MB, 256 MB, 512 MB and 1 GB technologies for x8 and x16 devices.

Top View of a 184-pin DIMM Slot

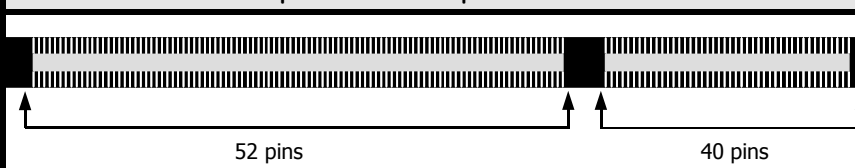

Important: The DIMM's can only be fitted into the slots in one orientation. Make sure that the DIMM's are in the correct orientation and the pins are correctly aligned before you insert them.

Hardware Installation

NOTE: "Out Of Memory" Error Message

If you have installed more than 512 MB of RAM and are running Microsoft Windows Millennium Edition, Windows 98 Second Edition, Windows 98 or Windows 95 you may experience memory problems. Two symptoms of these problems are being unable to run an MS-DOS session while you are running Windows or the computer may stop responding while Windows is starting.

There are three possible solutions to this problem:

- 1) Reduce the amount of memory Vcache uses to 512 MB or less by altering the Max-FileCache setting in the System.ini file.
- 2) Use the System Configuration Utility to reduce the amount of memory Windows uses to 512 MB or less.
- 3) Reduce the memory installed on your computer to 512 MB or less.

This problem can also occur if an Advanced Graphic Port (AGP) video adapter is used.

2.4.3. PCI Slots

The mainboard comes with **six** PCI slots. They are located on the left-hand side of the board. Both PCI and PCI expansion cards may require IRQ's. This mainboard complies with Plug and Play (PnP) specifications. Whenever a PnP compliant card is added the system will automatically be configured and the IRQ's will be assigned automatically.

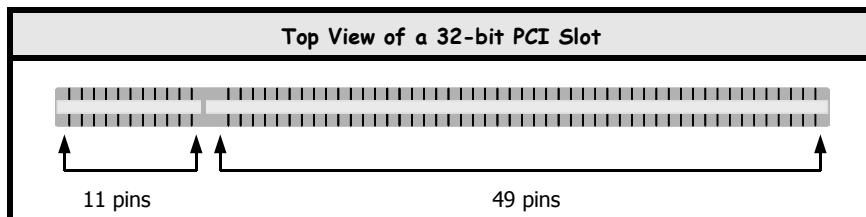

2.4.4. AGP (Accelerated Graphics Port) Slot

AGP is a dedicated bus slot. It operates at 66 MHz and transfers data at a rate up to 533 MB(8x). This allows 3D applications to run more smoothly. The mainboard comes with a **1.5V** AGP slot which is able to support 4x/8X AGP cards.

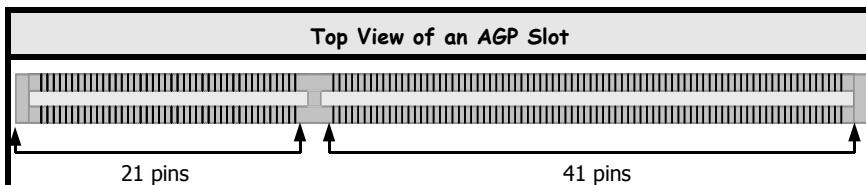

Hardware Installation

2.5. Internal Connectors

2.5.1. Floppy Disk Drive Connector

Connector: CN8 (FDC)
Type: 34 pin block

The FDC connector can support two floppy drives. It is located at the front of the mainboard. To connect, use the ribbon cable that has been provided. Make sure that the red strip is connected to Pin 1 of the connector.

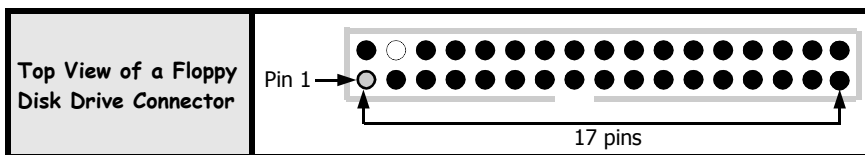

2.5.2. Primary and Secondary IDE Connectors

Connector: CN9 (IDE1)/CN10 (IDE2)
Type: 40 pin block

The mainboard has two IDE connectors: a primary and secondary. Each IDE connector can support two IDE drives. The mainboard each can therefore support up to four IDE devices. If you install two hard drives, you need to configure the second drive to **Slave** mode in the BIOS setup. Please refer to your hard drive manual for the appropriate jumper settings.

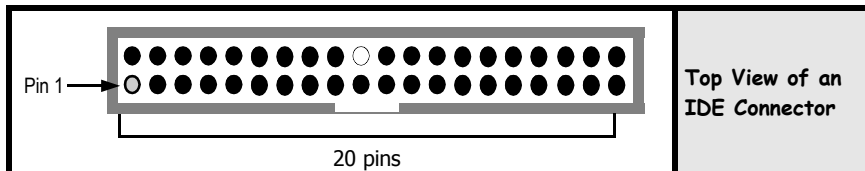

2.5.3. Infrared Connector (Optional)

Connector: CN12 (IR)
Type: 5 pin

The IR connector supports an optional wireless transmitting and receiving module. Please make sure the Pin 1 location.

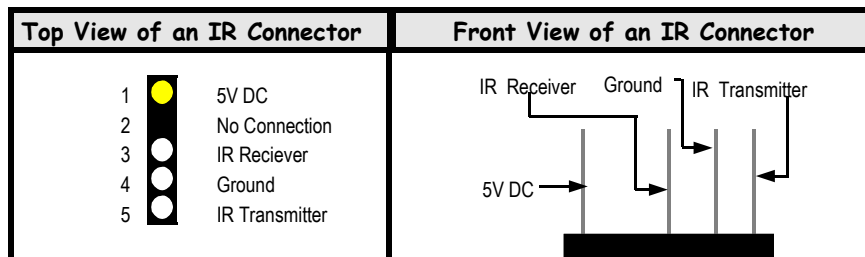

Hardware Installation

2.5.4. CPU Fan and Chassis Fan Connectors

Connector: CN13 (FAN1)/CN17 (FAN2)

Type: 3 pin

The cooling fans must be connected to their respective power connectors. If you have installed the hardware-monitoring feature you will be able to monitor the rotating speed of the CPU cooling fan in your Windows operating system.

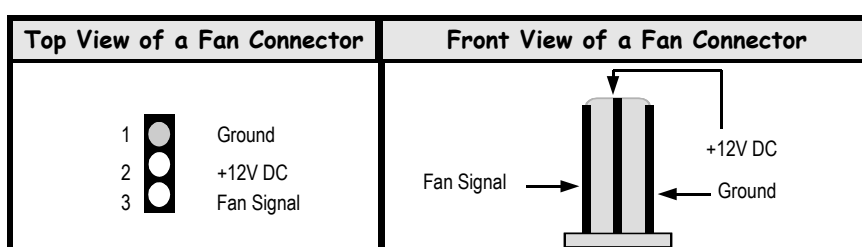

2.5.5. ATX Power Supply Connectors

Connector: CN15-A/CN15-B/CN15-D

Type: 20 pin block/2x2 12V/1x4 AUX12V

The mainboard comes with three onboard power supply connectors labeled CN15-A, CN15-B and CN-15D. CN15-A and CN15-B are regular ATX12V power supply connectors. CN15A and CN15D are regular ATX power supply connectors. The auxiliary power supply connector (CN15-D) is for a +12V and +5V power supply. These increased power supplies are necessary to provide extra power for the slot. The ATX 12V power supplies are all downward compatible with standard ATX power supplies.

ATX Connectors Pin Assignments					
CN15-A			CN15-B		
Pin 1	+3.3VDC	Pin 11	+3.3VDC	Pin 1	COM
Pin 2	+3.3VDC	Pin 12	-12VDC	Pin 2	COM
Pin 3	COM	Pin 13	COM	Pin 3	+12VDC
Pin 4	+5VDC	Pin 14	PS_ON#	Pin 4	+12VDC
Pin 5	COM	Pin 15	COM	CN15-D	
Pin 6	+5VDC	Pin 16	COM	Pin 1	+12VDC
Pin 7	COM	Pin 17	COM	Pin 2	COM
Pin 8	PWR_OK	Pin 18	-5VDC	Pin 3	COM
Pin 9	+5VSB	Pin 19	+5VDC	Pin 4	+5VDC
Pin 10	+12VDC	Pin 20	+5VDC		

Hardware Installation

2.5.6. CD-IN/AUX-IN Connector

Connector: CN21 (CD-IN)/CN45 (AUX-IN)

Type: 4 pin un-housed

The mainboard has one CD-IN connector and one AUX-IN connector. The **CD-IN** connector is used to connect the CD ROM audio out and allows the system to receive audio input from the CD ROM. The **AUX-IN** connector allows the system to receive signals from other audio devices like a radio or tape.

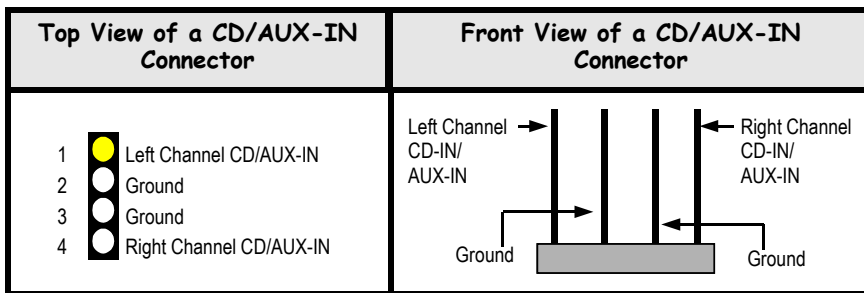

2.5.7. WOL (Wake-On-LAN) Connector

Connector: CN16 (WOL)

Type: 3 pin

The mainboard has a WOL (Wake-On-LAN) connector. This connector must be connected to a LAN card that has Wake-On-LAN (WOL) output. This connector powers up the system when a wakeup packet or signal is received through the LAN card.

In order to use the WOL LAN card to trigger the power on the PC system, the switching power supply must have the ability to provide a driving current of at least 720 mA and be connected to a "5V standby" voltage.

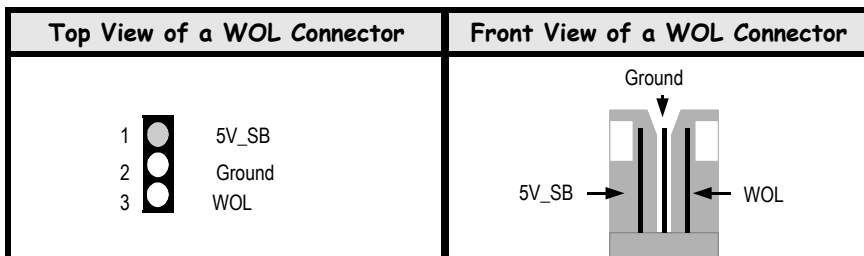

2.5.8. S/PDIF Connector (Optional)

Connector: CN36 (S/PDIF)

Type: 4 pin un-housed

The Sony Phillips Digital Interface, S/PDIF, connector is a digital interface that can be used to improve the quality of the sound output from your system.

Hardware Installation

2.5.9. USB3, USB4, USB5, USB6 Connectors

Connector: CN30 (USB 3)/CN31 (USB 4)/CN32 (USB5)/CN38 (USB6)

Type: 5 pin

You already have two USB2.0 ports available, USB1 and 2 (see external connectors). The internal USB connectors allow you to add on an optional kit to expand the total number of USB ports available. The mainboard has four internal USB2.0 connectors (CN30/CN31/CN32/CN38). This enables you to use an extra four USB devices. Cable for these additional connectors needs to be purchased separately.

Note: The PIN assignment of the internal USB 2.0 connectors (CN30, CN31, CN32 and CN38) are follow the specifications of Intel standard.

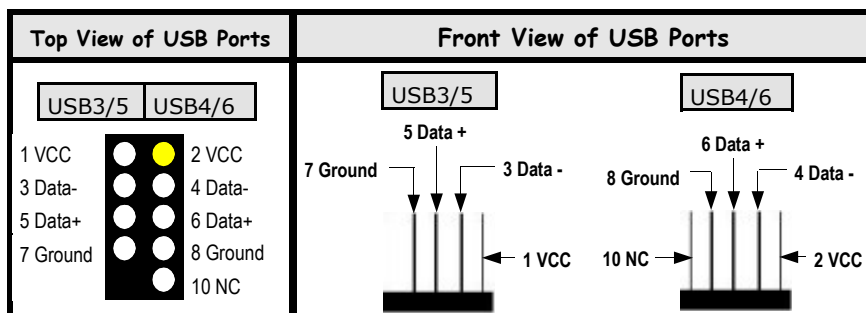

2.5.10. Front Audio Connector

Connector: CN39 (Front Audio)

Type: 10 pin

This connector is designed to be used with a Front-Utility Panel. The utility panel was developed so that a user is able to bring the speaker out, microphone in connectors to the front of their PC. This makes things like plugging in speakers and earphones much less troublesome.

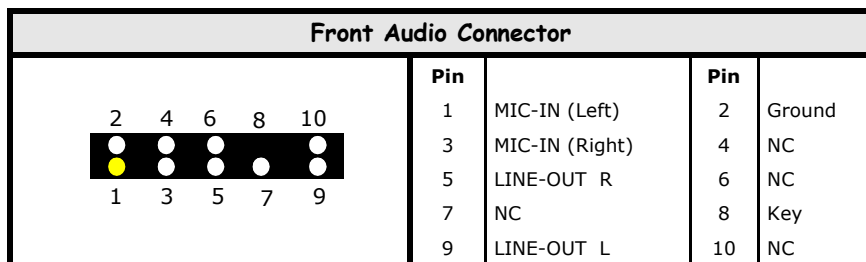

Hardware Installation

2.5.11. 4-Channel OUT Connector

Connector: CN46 (4 CH OUT)
 Type: 6 pin

This mainboard has the capability of 5.1 channel sound surrounded function, specifically sound effect that is destined for DVD or DTS home entertainment playback. In order to fully get the sound surrounded effect, this connector has to be used together with the Audio portion of the PC 99 ATX external connector on the mainboard. Special audio cable for this connector is attached. Please refer the following drawings or schematics to have the right connection for your sound systems.

4 CH OUT Connector					
	Pin		Pin		
1	1	Rear Left Channel	2	2	Rear Right Channel
3	3	Ground	4	4	Ground
5	5	Center	6	6	LFE (WOOFER)

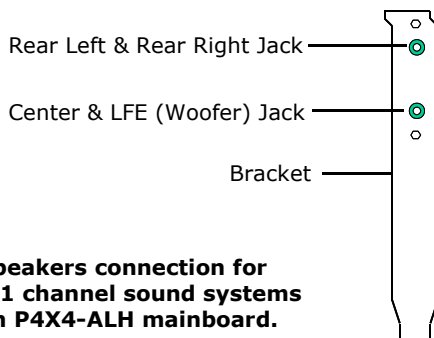
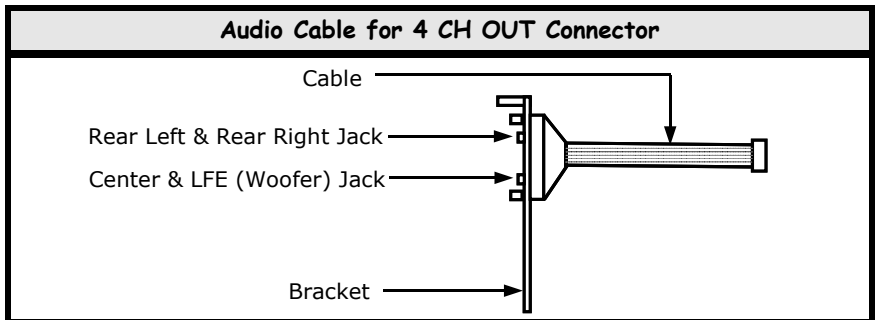

Speakers connection for 5.1 channel sound systems on P4X4-ALH mainboard.

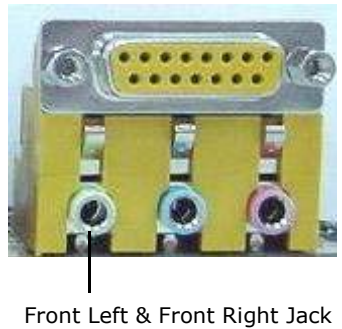

Hardware Installation

2.6. System Panel Buttons and LED Connectors

The following System Panel Buttons and LED Connectors (2 x 4 pins) can be found at the front of the mainboard on the left hand side.

PW = Power On/Off and Suspend Switch Connector

SL = Sleep LED Connector

HL = HDD LED Connector

RS = Reset Button Connector

RS: Reset Control

HL: +5V DC Pull Up

SL: Signal Pin

PW: +5V DC Pull Up

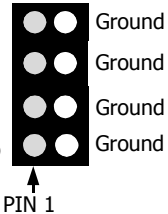

Top View of the System Panel and LED Connectors

2.6.1 PW: Power On/Off and External Suspend Switch Connector

The Power On/Off connector has two functions. It can be the Power Switch or Suspend Switch of your PC system. You can either choose "**Delay 4 Sec**" or "**Instant OFF**".

Option 1: If you choose "**Delay 4 Sec.**" In the BIOS CMOS Setup, the function of "PW" will be:

- When the system power is "OFF", press this switch, the system will power on.
- When system power is "ON", you can select two different modes: -

Mode 1: Press and hold the Power ON button for less than 4 seconds and then release it. The system will be turned into Suspend mode (turned into the GREEN mode) When the system is in the Suspend mode:

- Press the Power on button (less than 4 seconds), the system will return to Full-ON mode.
- Press and hold the Power On Button for more than 4 seconds, the system will be powered off.

Mode 2: Press and hold the Power ON button for more than 4 seconds, the system will be completely powered off.

Option 2: If you choose "**Instant OFF.**" In the BIOS CMOS Setup, the power switch will operate like a normal ON / OFF Power button.

2.6.2. SL: Sleep LED Connector

When lighted, the LED indicates that the AC power is ON but your system is switched OFF. When unlighted, the LED indicates that either the AC power is OFF/Unconnected or the system is switched ON.

2.6.3. HL: IDE HDD LED Connector

Any read and write activity by the HDD will turn this LED on.

2.6.4. RS: Reset Button Connector

If you connect this connector, you will be able to reset you computer by pressing the reset button at the front of the chassis.

Hardware Installation

2.7. Speaker and Power LED Connectors

2.7.1. Speaker Connector (SPKR)

Connect your chassis speaker to this four-pin connector. It allows you to hear systems beeps and warnings sound.

PIN 1

2.7.2. Front Panel Power LED (PWRLED)

PIN 1

The chassis power LED connector can be connected to the four-pin connector. When you turn your system on, this LED will also be turned on.

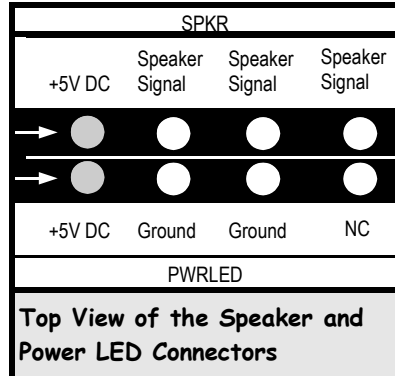

2.8. External Connectors

2.8.1. PS/2 Keyboard Connector

Connector: CN1 (K/B)
Type: 6 pin female



This connector only supports a PS/2 keyboard plug. If you have a standard AT size (large DIN) keyboard plug, you need to use a mini DIN adapter.

2.8.2. PS/2 Mouse Connector

Connector: CN2 (M/S)
Type: 6 pin female



This connector only supports a PS/2 mouse plug. If a PS/2 mouse is detected then IRQ 12 will be directed to **CN2**.

2.8.3. Serial Port Connectors

Connector: CN3 (COM 1)/CN4 (COM2)
Type: 9 pin male

One serial port is available for a mouse and other serial devices. (I/O addresses used are 3F8H/2F8H/3E8H/2E8H and IRQ3/IRQ4, selected by CMOS setup.)

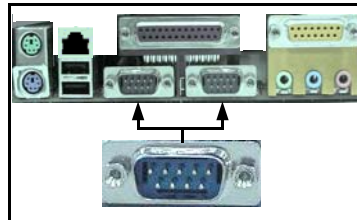

Hardware Installation

2.8.4. Parallel Port Connector

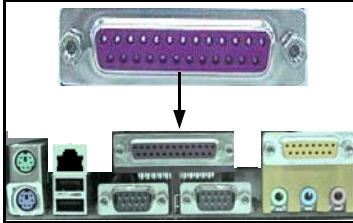

Connector: CN5 (LPT)

Type: 25 pin female.

This parallel port is used by printers which support the SPP, EPP and ECP modes IRQ7 or IRQ5 can be selected. The ECP mode will use either DMA 3 or DMA 1 (which can be selected by the BIOS setup program).

2.8.5. Universal Serial Bus (USB) Ports

Connector: CN6 (USB 1)/CN7 (USB 2)

Type: 4 pin female

Two USB ports are available for connecting USB devices. The mainboard is also equipped with an expansion connector that supports two additional USB external connectors. (The USB cable is not included in the package).

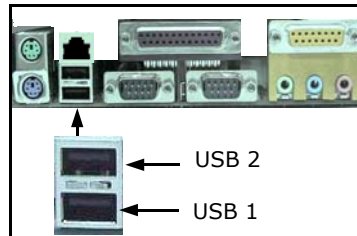

2.8.6. Audio/Game Connector

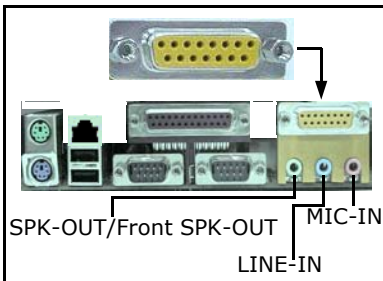

Connector: CN18

Type: 15 pin female

The Audio/Game port connector is a dual purpose connector. It can either be used to connect a joystick to the computer for game participation, or it can be used to attach an external MIDI device. All these motherboards have 3D audio interfaces onboard.

2.8.7. RJ-45 (LAN Port) Connector

Connector: CN35 (LAN)



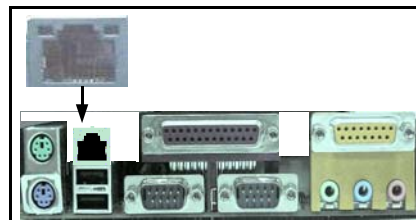

The mainboard comes with onboard 10/100 Mb Fast Ethernet Network. The RJ-45 connector allows you to easily connect to a Local Area Network (LAN) through a network hub.

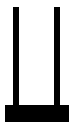

Hardware Installation

2.9. Jumper Settings

Jumpers are built on the mainboard to allow the user flexibility to configure the mainboard settings to meet their specific requirements. The mainboard comes with **five** jumpers, **three** 3-pin and **two** 2-pin jumper. When there is no jumper cap inserted into the jumper it is called "OPEN." When a cap is inserted into the jumper it is known as a "SHORT." Below are examples of short settings or open settings on a jumper.

Two-Pin Jumper		Three-Pin Jumper		
		<div style="display: flex; justify-content: space-around;"> <div style="text-align: center;"> PIN: 1 2 3  </div> <div style="text-align: center;"> PIN: 1 2 3  </div> </div>		
Open	Short	SHORT	Pin 1/Pin 2	Pin 2/Pin 3

2.9.1. JP1: Keyboard Power

Type: 3 pin (K/B Power)

Default: Pin 1 and Pin 2 Short

This jumper allows you to Power On your system using your mouse or keyboard. If you short Pin 1 and Pin 2 then the "Keyboard/Mouse Wakeup" function will be disabled. If Pin 2 and Pin 3 are short then the "Keyboard/Mouse Power On" function will be enabled. If you choose to enable this option then you need to enable the **POWER ON** field in the **Power Management Setup - IRQ/Event Activity Detect** Menu of the BIOS setup.

2.9.2. JP3: USB1, USB2 Power

Type: 3 pin

Default: Pin 1 and Pin 2 Short

This jumper allows you to select the voltage that is supplied to USB1 and USB2. You have two choices: 5 V (pin 1 and pin 2 short) or standby 5 V (pin 2 and pin 3 short). Some USB devices may not follow the standard USB power specifications. If you are using such a device it may unstable. If you do experience problems try to change the setting on Pin 2 and Pin 3. This might help solve this problem.

2.9.3. JP5: CPU Clock

Type: 2 pin

Default: Short

If this jumper is short, the mainboard will automatically detect the CPU clock speed FSB 400 MHz or 533MHz. If this jumper is open then the FSB will be forced to be 533 MHz.

Hardware Installation

2.9.4. JP8: Check 1.5V AGP (otional)

Type: 2 pin

Default: Open

This jumper can be used to check if your AGP card is 1.5V or 3.3V. If you open this jumper then the system will check to see what type of AGP card you are using. If a 3.3V card is detected your system will not boot.

Note: The jumper must be made **Open** after the AGP card has been inserted into the slot. If this jumper remains **Short** the system will boot with both a 1.5V and 3.3V AGP card.

Warning: if you are using a 3.3V AGP card you may damage your system.

2.9.5. JP9: Clear CMOS

Type: 3 pin

Default: Pin 1 and Pin 2 Short

If you have made an improper setting in the BIOS setup and your computer is not functioning, or if you have forgotten your password, you can use this jumper to clear the CMOS memory and to reconfigure your system.

To clear the CMOS, please follow these instructions:

1. Turn the system power off and unplug your computer;
2. Insert the jumper cap on Pin 2 and Pin 3 for 3 ~ 5 seconds;
3. Pull out the jumper cap and replace it on Pin 1 and Pin 2;
4. Turn your PC on and run the BIOS setup program.

Managing The PC BIOS

Chapter 3 - Managing the PC BIOS

3.1. Award BIOS CMOS Setup Utility

Once you have installed the mainboard you still need to setup the BIOS before you can run your PC. The EEPROM on the mainboard stores the AWARD BIOS CMOS Setup Utility, which allows you to configure your system. When you want to configure or make any changes to the configuration of your system BIOS you must run the BIOS CMOS Setup Utility.

GETTING STARTED

Every time you start your computer, the system provides you with an opportunity to run the BIOS CMOS Setup Utility. As soon as you turn on your system, press the <Delete> button to activate the BIOS CMOS Setup Utility.

If your computer finishes the POST (Power-On-Self-Test) the BIOS CMOS Setup Utility will **not be** activated. If your computer completes the POST you need to restart the system to activate the BIOS CMOS Setup Utility. To restart the system, you can either turn the power off, press the reset button on your chassis or press the <Ctrl> + <Alt> + <Delete> button. In all three cases the system will restart and, to activate the BIOS CMOS Setup Utility, you must immediately press the <Delete> button.

3.2. Main Menu

Phoenix - AwardBIOS CMOS Setup Utility	
<ul style="list-style-type: none">▶ Standard CMOS Features▶ Advanced BIOS Features▶ Advanced Chipset Features▶ Integrated Peripherals▶ Power Management Setup▶ PNP/PCI Configuration▶ PC Health Status	<ul style="list-style-type: none">▶ Frequency/Voltage ControlLoad Fail-Safe DefaultsLoad Optimized DefaultsSet Supervisor PasswordSet User PasswordSave & Exit SetupExit Without Saving
Esc : Quit	← ↑ ↓ → : Select Item
Time, Date, Hard Disk Type ...	

Note! BIOS software is continuously updated therefore the BIOS menus and the descriptions that are given in this manual are for reference purposes only.

Managing The PC BIOS

Navigation Keys

You will notice a legend bar at the bottom of the main menu. The keys in this legend bar show you how to navigate through the setup menus. The table below lists the control keys with their corresponding functions:

Control Key	Function
Up Arrow	Moves to the previous item.
Down Arrow	Moves to the next item.
Left Arrow	Moves to the item on the left.
Right Arrow	Moves to the item on the right.
Enter	Selects the desired item.
F1	Displays the help screen for the selected feature.
Esc key	Exits to the previous screen.
PgUp(-)/PgDn(+)	Modifies or changes the content of the highlighted item.
F5	Restores the previous CMOS values to the current page setup. This will not restore the previous values for any other pages.
F7	Loads the SETUP default values from BIOS default table, (only the current page setup will be loaded).
F10	Saves changes to the CMOS and exits the setup.

3.3. Standard CMOS Setup *(This menu is on page 27)*

Date (mm : dd : yy)

Sets your system to the date that you specify (usually the current date). The format is month, day, and year. Press the right or left arrow key to move to the desired field (month, date, year). Press the PgUp or PgDn key to increment the setting, or type the desired value into the field.

Time (hh : mm : ss)

Sets your system to the time you specify (usually the current time). The format is hour, minute, second. The time format is based on the 24-hour military-time clock. For example, 1 P.M. is 13:00:00. Press the right or left arrow key to move to the desired field. Press the PgUp or PgDn key to increment the setting, or type the desired value into the field.

IDE Primary / Secondary Master / Slave

This mainboard supports four IDE Hard Drives. These fields allow you to set your Hard Drive parameters. Move the selection bar to the IDE Hard Drive you want to configure. Press the "ENTER" key. If you select "AUTO" the system BIOS will detect the HDD type automatically.

Managing The PC BIOS

Phoenix - AwardBIOS CMOS Setup Utility Standard CMOS Features

Date (mm : dd : yy)	Fri, Jul 26, 2002	Item Help
Time (hh : mm : ss)	15 : 48 : 52	
▶ IDE Primary Master	[Maxtor 52049H4]	Menu Level ▶ Change the day, month, year and century
▶ IDE Primary Slave	[None]	
▶ IDE Secondary Master	[None]	
▶ IDE Secondary Slave	[None]	
Drive A	1.44, 3.5 in	
Drive B	None	
Floppy 3 Mode Support	[Disabled]	
Video	EGA/VGA	
Halt On	All Errors	
Base Memory	640K	
Extended Memory	65472K	
Total Memory	1024K	

Drive A / B

The mainboard can support up to two floppy disk drives. These two selection fields allow you to select the floppy drives that are installed on your computer. Select the correct specifications for the diskette drive(s) installed on your computer.

Floppy 3 Mode Support

If you have installed a 3.5 inch high capacity floppy disk drive you need to enable this option. If you have not installed one of these drives use the default setting.

Diskette Drive	Type of Disk Drive	Capacity
None	No diskette drive installed	
360K 5.25 in	5-1/4 inch PC-type standard drive	360 KB
1.2M 5.25 in	5-1/4 inch AT-type high-density drive	1.2 MB
720K 3.5 in	3-1/2 inch single-sided drive	720 KB
1.44M 3.5 in	3-1/2 inch double-sided drive	1.44 MB
2.88M 3.5 in	3-1/2 inch double-sided drive	2.88 MB

Video

This field selects the type of primary video subsystem that is on your computer. The BIOS CMOS Setup Utility will automatically detect the correct video type.

Managing The PC BIOS

EGA/VGA	Enhanced Graphics Adapter/Video Graphics Array. For EGA, VGA , SEGA, SVGA or PGA monitor adapters
CGA 40	Color Graphics Adapter power up in 40 column mode
CGA 80	Color Graphics Adapter power up in 80 column mode
MONO	Monochrome adapter includes high resolution monochrome adapters

Halt On

This field allows you to decide which errors, detected during the Power On Self Test (POST), will halt the system.

Base Memory / Extended Memory / Total Memory

This field displays the amount of memory detected by the system during boot up. This is a display only field. You cannot make any changes to this field.

Base Memory: Indicates the memory installed below the conventional 1MB space.

Extended Memory: Indicates the memory installed above the 1MB space.

Total Memory: Indicates the total memory installed in the PC system.

3.4. Advanced BIOS Features

Phoenix - AwardBIOS CMOS Setup Utility Advanced BIOS Features		
		Item Help
Virus Warning	[Disabled]	Menu Level ▶ Allows you to choose the VIRUS warning feature for IDE Hard disk boot sector protection. If this function is enabled and someone attempts to write data into this area, BIOS will show a warning message on screen and alarm beep.
CPU L1 & L2 Cache	[Enabled]	
CPU L2 Cache ECC Checking	[Enabled]	
Quick Power On Self Test	[Enabled]	
First Boot Device	[Floppy]	
Second Boot Device	[HDD-0]	
Third Boot Device	[LS120]	
Boot Other Device	[Enabled]	
Swap Floppy Drive	[Disabled]	
Boot Up Floppy Seek	[Enabled]	
Boot Up NumLock Status	[On]	
Typematic Rate Setting	[Disabled]	
X Typematic Rate (Chars/Sec)	6	
X Typematic Delay (Msec)	250	
Security Option	[Setup]	
PS/2 Mouse Function Control	[Enabled]	
OS Select For DRAM > 64 MB	[Non-OS2]	
HDD S.M.A.R.T Capability	[Disabled]	
Video BIOS Shadow	[Enabled]	
Full Screen Logo Show	[Disabled]	
Small Logo (EPA) Show	[Disabled]	

Managing The PC BIOS

Virus Warning

When you enable the virus warning you will receive a warning message whenever a program (specifically, a virus) attempts to write to the boot sector or the partition table of the hard disk drive. If you receive such a message you should immediately run an anti-virus program. Keep in mind that this feature **only** protects the boot sector and not the entire hard drive.

Disk diagnostic programs that access the boot sector table can trigger the virus-warning message. If you run such a program, recommend that you first disable the virus warning.

CPU L1 & L2 Cache

This field can be used to enable or disable the system's primary (L1) or secondary (L2) cache.

CPU L2 Cache ECC Checking

When you select Enabled, the ECC checking will ensure that the data stored on the L2 cache is accurate.

Quick Power On Self Test

If enabled the amount of time required to run the power-on self-test (POST) will decrease. A quick POST skips certain steps. We recommend that you disable quick POST. It is better to find a problem during POST than to lose data during your work.

First / Second / Third Boot Device

These fields allow you to decide the boot sequence of your bootable devices such as Floppy Drive, Hard Drive, CD ROM...etc

Boot Other Device

When this field is enabled you will be able Boot your computer from a different device, not your HDD or FDD.

Swap Floppy Drive

This field is effective only in systems with two floppy drives. When Enabled is selected physical drive B is assigned to logical drive A, and physical drive A is assigned to logical drive B.

Boot Up Floppy Seek

When enabled, the BIOS tests (seeks) floppy drives to determine whether they have 40 or 80 tracks. Only 360-KB floppy drives have 40 tracks; drives with 720 KB, 1.2 MB, and 1.44 MB capacity all have 80 tracks. Very few modern PCs have 40-track floppy drives so we therefore recommend that you set this field to Disabled to save time.

Managing The PC BIOS

Boot Up NumLock Status

This controls the state of the NumLock key when the system boots. This field is toggled between On or Off. When it is on the numeric keypad generates numbers instead of controlling the cursor operations. When it is off the numeric keypad controls cursor operations and does not generate numbers.

Typematic Rate Setting

The keyboard controller determines the rate at which the keystrokes from the keyboard are repeated. If enabled the typematic rate and the typematic delay can be selected.

Typematic Rate

The rate a character will repeat itself on the screen when you hold down a key.

Typematic Delay

This is the delay time (Msec) before the repetition of characters starts.

Security Option

This field allows you to select the "Setup" or "System" security option. It works concurrently with the "Set Supervisor Password" in the main menu.

When the "Setup" option is selected, you will be prompted to enter your "Password" before you can start the BIOS CMOS Setup Utility. When you select "System" option, you will be prompted to enter your password in order to load the Operating System.

TIP: Forgot your password then clear the RTC RAM

If you happen to forget your password you can use Jumper 9 (JP9) to clear the password by erasing the CMOS Real Time Clock (RTC) Ram. Please see section 2.9.5. on page 24.

OS Select For DRAM > 64MB

Only select OS2 if you are running an OS/2 operating system with a RAM greater than 64 Mb. Otherwise, for all other operating systems, use the default setting "Non-OS2"

HDD S.M.A.R.T Capability

You may "enable" this option if your Hard Drive supports the S.M.A.R.T technology (Self Monitoring Analysis Reporting Technology) feature. S.M.A.R.T will monitor and report your Hard Drive health status. Ask your Hard Drive vendor for more information.

NOTE: Using this feature may decrease system performance.

Video BIOS Shadow

These fields allow you to change the Video BIOS location from ROM to RAM. Information access is faster through RAM than ROM. Therefore when you enable this option you will enhance your system performance.

Managing The PC BIOS

3.5. Advanced Chipset Features

Phoenix - AwardBIOS CMOS Setup Utility Advanced Chipset Features		
▶ DRAM Clock/Drive Control	[Press Enter]	Item Help
▶ AGP & P2P Bridge Control	[Press Enter]	
▶ CPU & PCI Bus Control	[Press Enter]	
Memory Hole	[Disabled]	Menu Level ▶
System BIOS Cacheable	[Disabled]	
Video RAM Cacheable	[Disabled]	
Delay Prior To Thermal	[16 Min]	

DRAM Clock Drive Control

This field allows you to select the FSB and DRAM frequency. When you press enter the following menu will appear.

Phoenix - AwardBIOS CMOS Setup Utility DRAM Clock/Drive Control		
Current FSB Frequency	100 MHz	Item Help
Current DRAM Frequency	133 MHz	
DRAM Clock	[By SPD]	Menu Level ▶ ▶
DRAM Timing	[By SPD]	
X SDRAM CAS Latency	3	
X Bank Interleave	[Disabled]	
X Precharge to Active (Trp)	3T	
X Active to Precharge (Tras)	7T	
X Active to CMD (Trcd)	3T	
X DRAM Command Rate	2T Command	
DRAM Burst Len	[4]	
Write Recovery Time	[3T]	

▶ Current FSB Frequency

The setting for this field will be automatically selected by the BIOS.

▶ Current DRAM Frequency

The setting for this field will be automatically detected by the BIOS. The value that is selected is derived from the RAM clock.

▶ DRAM Clock

When you press enter you will have three options:

By SPD :The BIOS will automatically detect the actual DRAM Clock.

100 MHz :The DRAM clock speed will be PC1600 (100 MHz DDR).

133 MHz :The DRAM clock speed will be PC2100 (133 MHz DDR).

166MHz :The DRAM clock speed will be PC2700 (166 MHz DDR).

▶ DRAM Timing

This field enables/disables you from selecting the values for following six fields manually. These (six) fields determine the DRAM read/write timing. If you select **By SPD** then those fields will be automatically configured by the system BIOS. (The performance parameters of the installed memory chips (DRAM) determines the value in those fields.)

Managing The PC BIOS

If you select Manual you will need to enter the values for those fields. You should not change the values of those fields from the factory setting unless you have installed new memory that has a different performance rating than the original DRAMs.

▸ **SDRAM CAS Latency**

Before SDRAM can execute a read command that it receives, there is a delay time, which is measured in clock cycles (CLK). Some memory modules are unable to deal with short delay times. We recommend that you set this delay time between 1.5, 2, 2.5 and 3 CLK's (the default is 3). If your system becomes unstable we recommend that you increase the delay time.

AGP & P2P Bridge Control

When you press enter the following menu will appear:

Phoenix - AwardBIOS CMOS Setup Utility AGP & P2P Bridge Control		
AGP Aperture Size	[128M]	Item Help
AGP Mode	[4X]	Menu Level ▸ ▸
AGP Driving Control	[Auto]	
X AGP Driving Value	DA	
AGP Fast Write	[Disabled]	
AGP Master 1 WS Write	[Disabled]	
AGP Master 1 WS Read	[Disabled]	
DBI Output for AGP Trans.	[Disabled]	

▸ **AGP Aperture Size**

This field selects the size of the Accelerated Graphics Port (AGP) aperture. The aperture is a portion of the PCI memory address range dedicated for graphics memory address space. Host cycles that hit the aperture range are forwarded to the AGP without any translation. The default is 128MB. You may increase this memory when you need to have faster access for 3D graphics applications (e.g. games).

▸ **AGP Driving Control**

The recommended setting for this field is the default "Auto". If you have an unstable AGP card you may use this field to choose the appropriate settings. If you do need to tune the timing, please consult your AGP Card manual or Vendor.

▸ **AGP Driving Value**

This item allows you to adjust the AGP driving force.

▸ **AGP Master 1 WS Write**

When Enabled, writes to the AGP are executed with one-wait states.

▸ **AGP Master 1 WS Read**

When Enabled, reads to the AGP are executed with one-wait states.

Managing The PC BIOS

CPU & PCI Bus Control

When you select this field the following menu will appear:

Phoenix - AwardBIOS CMOS Setup Utility CPU & PCI Bus Control		
CPU to PCI Write Buffer	[Enabled]	Item Help
PCI Master 0 WS Write	[Enabled]	Menu Level ▶ ▶
PCI Delay Transaction	[Disabled]	

▶ CPU to PCI Write Buffer

If enabled, writes from the CPU to the PCI bus will be buffered so that the CPU will not have to wait until the write is completed before starting another write cycle.

▶ PCI Master 0 WS Write

If enabled, writes to the PCI bus are executed with zero wait states

▶ PCI Master 0 WS Write

The chipset has an embedded 32-bit posted write buffer to support delay transaction cycles. Select enabled to support compliance with PCI specification version 2.1.

Memory Hole

You can reserve this area of system memory for ISA adapter ROM. When this area is reserved, it cannot be cached. The user information of peripherals that need to use this area of system memory usually discusses their memory requirements.

System BIOS Cacheable

Selecting "Enabled" allows caching of the system BIOS ROM. This results system performance. However, if any program writes to this memory area, a system error may occur.

Video RAM Cacheable

Select Enabled allows caching of the video RAM, resulting in better system performance. However, if any program writes to this memory area, a system error may occur.

Delay Prior to Thermal

This item allows you to select the delay time before the P4 CPU Thermal Function is enabled. If you are using NT 4.0 you must be active to prevent the system from hanging. The options are: 4 min, 8 min, 16 min and 32 min.

Managing The PC BIOS

3.6. Integrated Peripherals

Phoenix - AwardBIOS CMOS Setup Utility Integrated Peripherals		
▶ VIA OnChip IDE Device	[Press Enter]	Item Help
▶ VIA OnChip PCI Device	[Press Enter]	Menu Level ▶
▶ SuperIO Device	[Press Enter]	
Init Display First	[PCI Slot]	
OnChip USB Controller	[All Enabled]	
USB Keyboard Support	[Disabled]	
IDE HDD Block Mode	[Enabled]	

VIA OnChip IDE Device

When you press enter the following menu will appear:

Phoenix - AwardBIOS CMOS Setup Utility VIA OnChip IDE Device		
OnChip IDE Channel0	[Enabled]	Item Help
OnChip IDE Channel1	[Enabled]	Menu Level ▶ ▶
IDE Prefetch Mode	[Enabled]	
Primary Master PIO	[Auto]	
Primary Slave PIO	[Auto]	
Secondary Master PIO	[Auto]	
Secondary Slave PIO	[Auto]	
Primary Master UDMA	[Auto]	
Primary Slave UDMA	[Auto]	
Secondary Master UDMA	[Auto]	
Secondary Slave UDMA	[Auto]	

▶ OnChip IDE Channel 0/1

The chipset contains a PCI IDE interface with support for two IDE channels. To activate the primary IDE interface select Enabled. If you want to disable the onboard IDE 1 and/or 2, then select Disabled and this interface will be deactivated.

▶ OnChip IDE Channel 0/1

The chipset contains a PCI IDE interface with support for two IDE channels. To activate the primary IDE interface select Enabled. If you want to disable the onboard IDE 1 and/or 2, then select Disabled.

▶ IDE Prefetch Mode

The onboard IDE drive interfaces supports IDE pre-fetching for faster drive access. If you install a primary and/or secondary add-in IDE interface which does not support pre-fetching set this field to Disabled.

Managing The PC BIOS

▶ **Primary/Secondary, Master/Slave PIO**

The four IDE PIO (Programmed Input/Output) fields let you set a PIO mode (0-4) for each of the four IDE devices that the onboard IDE interface supports. Modes 0 through 4 provide successively increased performance. In Auto mode, the system automatically determines the best mode for each device.

▶ **Primary/Secondary, Master/Slave UDMA**

Ultra DMA/66 implementation is possible only if your IDE hard drive supports it and the operating environment includes a DMA driver (Windows 98 OSR2 or a third-party IDE bus master driver). If your hard drive and your system software both support Ultra DMA/66, select Auto to enable BIOS support.

VIA OnChip PCI Device

When you select this field the following menu will appear:

Phoenix - AwardBIOS CMOS Setup Utility VIA OnChip PCI Device		
VIA-3058 AC97 Audio	[Auto]	Item Help
VIA-3043 OnChip LAN	[Enabled]	Menu Level ▶ ▶
Onboard LAN Boot ROM	[Disabled]	

▶ **VIA-3058 AC97 Audio**

If you want to enable the on-chip audio capabilities of your system you need use the default setting "Auto". If you install an add on sound card you must disable this field.

▶ **VIA-3043 OnChip LAN**

This field allows you to decide whether you want this support or not. If you select "Enabled" the BIOS will automatically detect the LAN chip. If you select "Disabled" the Bios will not detect any on-chip LAN function.

▶ **Onboard LAN Boot ROM**

This field can be used to enable or disable the Boot ROM of the onboard VIA 10/100 Adapter LAN Chip to support the boot up of a diskless client functionality unit.

SuperIO Device

When you press enter the following menu on page 36 is shown

▶ **Onboard FDC Controller**

Select Enabled if your system has a floppy disk controller (FDC) installed on the system board and you want to use it. If you install an add-in FDC or the system has no floppy drive, select Disabled in this field.

▶ **Onboard Serial Port 1/2**

These two selection fields allow you to select the I/O address and corresponding interrupts for the first and second serial port.

Managing The PC BIOS

Phoenix - AwardBIOS CMOS Setup Utility SuperIO Device

		Item Help
Onboard FDC Controller	[Enabled]	Menu Level ▶
Onboard Serial Port 1	[3F8/IRQ4]	
Onboard Serial Port 2	[2F8/IRQ3]	
UART Mode Select	[Normal]	
RxD, TxD Active	[Hi, Lo]	
IR Transmission Delay	[Enabled]	
UR2 Duplex Mode	[Half]	
Use IR Pins	[IR-Rx2Tx2]	
Onboard Parallel Port	[378/IRQ7]	
Parallel Port Mode	[SPP]	
EPP Mode Select	[EPP1.7]	
ECP Mode Use DMA	[3]	
Game Port Address	[201]	
Midi Port Address	[330]	
Midi Port IRQ	[10]	

▶ **UART Mode Select**

Your system may offer a variety of infrared modes on the second serial port. The options are Standard, HPSIR or ASKIR.

▶ **RxD, TxD Active**

This field allows you to set the IR reception/transmission polarity as high or low. To determine which polarity is appropriate you must refer to the documentation for your IR peripheral.

This field is usually found under the Onboard Serial Port 2 option. If you disable the Onboard Serial Port 2 option then you will probably not be able to configure this field.

▶ **IR Transmission Delay**

This field allows you to "Enable" or "Disable" the IR Transmission Delay.

▶ **UR2 Duplex Mode**

This field appears in an infrared port mode. You have two options: half or full duplex function. The full duplex mode allows bi-directional transmission at a single time where as the half duplex mode only allows transmission in one direction at a time. This setting depends on the nature of your IR peripheral device. Check the IR device's manual to determine the appropriate setting.

▶ **Use IR Pins**

To determine the correct settings for the TxD and RxD signals of your IR peripheral component, you need to consult the components manual.

▶ **Onboard Parallel Port**

This item allows you to determine the I/O address and the IRQ for the on-board parallel port. The default settings are adequate and should not give you any problems. If they do you can try to change them.

Managing The PC BIOS

▸ Onboard Parallel Mode

This field allows you to select an operating mode for the onboard parallel (printer) port. Select Normal, Compatible, or SPP unless you are certain your hardware and software both support one of the other available modes.

▸ EPP Mode Select

This field allows you to choose the EPP version you want to use. We recommend that you use EPP 1.9 for the best performance but if you do you may have some connection problems so try setting it to EPP 1.7.

▸ ECP Mode Use DMA

This item allows you to select a DMA channel for the parallel port for use during ECP.

▸ Game Port Address

This field allows you to select the I/O address for the onboard game port. The default is 201.

▸ Midi Port Address

This field allows you to select the I/O address for the onboard MIDI port. The default is 330.

▸ MIDI Port IRQ

This field allows you to select the IRQ for the onboard MIDI port. The default is 10.

Init Display First

This field allows a user, with two graphics cards installed on his system, to select which graphics card will be activated first: either the PCI graphics card or the AGP graphics card. If you have only installed one graphics card the BIOS will automatically detect it and you do not need to set this field.

OnChip USB Controller

This field allows you to enable or disable the onboard USB controller.

USB Keyboard Support

This field should only be enabled if you are using a USB keyboard. If you are not using this kind of keyboard you should disable it.

IDE HDD Block Mode

Block mode is also known as block transfer, multiple commands, or multiple sector read/write. If your IDE hard drive supports block mode select "Enabled" for automatic detection of the optimal number of block read/writes per sector the drive can support.

Managing The PC BIOS

3.7. Power Management Setup

Phoenix - AwardBIOS CMOS Setup Utility Power Management Setup		
ACPI Function	[Enabled]	Item Help
ACPI Suspend Type	[S1(POS)]	Menu Level ▶
Power Management Option	[User Define]	
HDD Power Down	[Disable]	
Suspend Mode	[Disable]	
Video Off Option	[Suspend -> Off]	
Video Off Method	[Blank Screen]	
MODEM Use IRQ	[3]	
Soft-Off by PWRBTN	[Instant-Off]	
PWRON After PWR-Fail	[Off]	
▶ IRQ/Event Activity Detect	[Press Enter]	

ACPI function

This item allows you to enable/disable the Advanced Configuration and Power Management (ACPI).

ACPI Suspend Type

This field selects the **S1(POS)** (Power On Suspend) suspend state mode.

Power Management

This category allows you to select the degree of power saving. The choices are shown in the table below.

Min. Power Saving	Minimum power management. Suspend Mode = 1 hr.
Max. Power Saving	Maximum power management -- ONLY AVAILABLE FOR SL CPU. Suspend Mode = 1 min.
User Defined	Allows you to set each mode individually. When not disabled, each of the ranges are from 1 min. to 1 hr. except for HDD Power Down which ranges from 1 min. to 15 min. and disable.

HDD Power Down

When enabled and after the set time of system inactivity, the hard disk drive will be powered down while all other devices remain active.

Suspend Mode

When enabled, after the set time of system inactivity, all devices except the CPU will be shut off.

Video Off Option

When enabled, this feature allows the VGA adapter to operate in a power saving mode.

Managing The PC BIOS

Always On	Monitor will remain on during power saving modes.
Suspend --> Off	Monitor blanked when the systems enters the Suspend mode.

Modem Use IRQ

This determines the IRQ which the MODEM can use for Power Saving purposes. This mainboard has the ACPI feature designed on the board and it will "wake-up" automatically when it detects an incoming modem Ring-in signal. Before you can use the Ring-in signal to wakeup your PC system, you have to install the "External" modem to your PC system and tell the PC system which serial port connects to the modem by selecting the IRQ in this field. (Officially COM1 uses IRQ4)

Video Off Method

This determines the manner in which the monitor goes blank.

V/H SYNC+Blank	This selection will cause the system to turn off the vertical and horizontal synchronization ports and write blanks to the video buffer.
Blank Screen	This option only writes blanks to the video buffer.
DPMS Support	Select this option if your monitor supports the Display Power Management Signaling (DPMS) standard of the Video Electronics Standards to select video power management values.

MODEM Use IRQ

This determines the IRQ which the MODEM can use for power saving purposes. This mainboard has the ACPI feature designed on the board and it will "wakeup" automatically when it detects an incoming modem Ring-in signal. Before you can use the Ring-in signal to wakeup your PC system, you have to install the "External" modem to your PC system and tell the PC system which serial port connects to the modem by selecting the IRQ in this field, (officially, COM 1 uses IRQ4, and COM 2 uses IRQ3)

Soft-Off by PWRBTN

Pressing the power button for more than 4 seconds forces the system to enter the Soft-Off state when the system has "hung".

PWRON After PWR Fail

See the following table for all the options.

Off:	When the power returns after an AC power failure the system's power is off. You must press the Power button to power-on the system
Former-Sts:	When power returns after an AC power failure, the system will return to the state where you left off before the power failure occurred. If the system's power is off when the AC power failure occurred, it will remain off when the power returns. If the system's power is on when the AC power failure occurred, the system will power-on when the power returns.

Managing The PC BIOS

IRQ/Event Activity Detect

When you press the "Enter" the following menu will appear:

Phoenix - AwardBIOS CMOS Setup Utility IRQ/Event Activity Detect		
PS2KB Wakeup Select	[Hot Key]	Item Help
PS2KB Wakeup from S3/S4/S5	[Disabled]	
X Power Button Lock	[Enabled]	Menu Level ▶
PS2MS Wakeup from S3/S4/S5	[Disabled]	
VGA	[OFF]	
LPT & COM	[LPT/COM]	
HDD & FDD	[ON]	
PCI Master	[OFF]	
PowerOn by PCI Card	[Disabled]	
LAN Resume	[Disabled]	
RTC Alarm Resume	[Disabled]	
X Date (of Month)	0	
X Resume Time (hh:mm:ss)	0 : 0 : 0	
▶ IRQs Activity Monitoring	[Press Enter]	

▶ **VGA**

When you enable this option, any VGA signal will wake up the system.

▶ **LPT & COM**

When this field is "ON" any activity from these devices, or their IRQ's will wake up the system.

▶ **HDD & FDD**

When this field is "ON" any activity from the HDD or the FDD will wake up the system.

▶ **PCI Master**

When you enable the PCI Master mode, any activity from one of the listed system peripheral devices wakes up the system.

▶ **Power On by PCI Card**

The system can be woken up by the PME# on the PCI card.

▶ **LAN Resume**

An input signal from the LAN will wake up the system from a soft off state.

▶ **RTC Alarm Resume**

When enabled, you can use the following two fields to select the time and date to wake up the PC system from power saving mode.

▶ **Date (of Month)/Resume Time (hh:mm:ss)**

When RTC Alarm Resume is enabled, you can set the date and time at which the RTC (real-time clock) alarm awakens the system from Suspend mode.

▶ **IRQs Activity Monitoring**

The following is a list of IRQ's, Interrupt ReQuests, which can be exempted much as the COM ports and LPT ports above can. When an I/O

Managing The PC BIOS

Device wants to gain the attention of the operating system, it signals this by causing an IRQ to occur. When the operating system is ready to respond to the request, it interrupts itself and performs the service.

Note: When set On, activity will neither prevent the system from going into a power management mode nor awaken it.

Phoenix - AwardBIOS CMOS Setup Utility IRQs Activity Monitoring

	Item Help
Primary INTR [ON]	Menu Level ▶
IRQ3 (COM 2) [Disabled]	
IRQ4 (COM 1) [Enabled]	
IRQ5 (LPT 2) [Enabled]	
IRQ6 (Floppy Disk) [Enabled]	
IRQ7 (LPT 1) [Enabled]	
IRQ8 (RTC Alarm) [Disabled]	
IRQ9 (IRQ2 Redir) [Disabled]	
IRQ10 (Reserved) [Disabled]	
IRQ11 (Reserved) [Disabled]	
IRQ12 (PS/2 Mouse) [Enabled]	
IRQ13 (Coprocessor) [Enabled]	
IRQ14 (Hard Disk) [Enabled]	
IRQ15 (Reserved) [Disabled]	

3.8. PNP/PCI Configuration

Phoenix - AwardBIOS CMOS Setup Utility PnP/PCI Configurations

	Item Help
PNP OS Installed [No]	Menu Level ▶ Select Yes if you are using a Plug and Play capable operating system. Select No if you need the BIOS to configure non-boot devices.
Reset Configuration Data [Disabled]	
Resources Controlled By [Auto(ESCD)]	
× IRQ Resources [Press Enter]	
PCI/VGA Palette Snoop [Disabled]	
Assign IRQ For VGA [Enabled]	
Assign IRQ For USB [Enabled]	

PNP OS Installed

This item allows you to determine if a PnP OS is installed or not.

Reset Configuration Data

Normally, you leave this field Disabled. If you have installed a new add-on and the system reconfiguration has caused such a serious conflict that the operating system cannot boot then select Enabled. Selecting Enabled will reset the Extended System Configuration Data (ESCD).

Managing The PC BIOS

Resources controlled By

Award Plug and Play BIOS has the capacity to automatically configure all of the boot and Plug and Play compatible devices. However, this capability means absolutely nothing unless you are using a Plug and Play operating system such as Windows 98.

IRQ Resources

When resources are controlled manually, assign each system interrupt a type, depending on the type of device using the interrupt

PCI/VGA Palette Snoop

Some display cards are non-standard VGA cards (such as graphics accelerators and MPEG cards) which may not display color properly on your screen. If this field is **Enabled** it may correct the problem. If you have a normal display card then leave this field **Disabled** as the default setting .

Assign IRQ For VGA/USB

A system's IRQs are limited. Sometimes you may need to use more IRQ signals for your add-on cards. BIOS allows you to disable the IRQ which is supposed to be connected to the VGA and USB ports. If you choose to disable the IRQ on the VGA or USB port, the IRQ will be released and becomes available for other devices. Please make sure that you have a USB or VGA adapter that does not need an IRQ before you select Disabled.

Assign IRQ For VGA/USB

A system's IRQs are limited. Sometimes you may need to use more IRQ signals for your add-on cards. BIOS allows you to disable the IRQ which is supposed to be connected to the VGA and USB ports. If you choose to disable the IRQ on the VGA or USB port, the IRQ will be released and becomes available for other devices. Please make sure that you have a USB or VGA adapter that does not need an IRQ before you select Disabled.

3.9. PC Health Status

Phoenix - AwardBIOS CMOS Setup Utility PC Health Status		
CPU Warning Temperature	[Disabled]	Item Help
Current CPU Temperature	55°C/131°F	Menu Level ▶
Current CPU FAN Speed	4821 RPM	
Current CHASSIS FAN Speed	0 RPM	
Vcore (V)	1.74 V	
+ 3.3 (V)	3.41V	
+ 5 V	4.75 V	
+ 12 V	12.09 V	
- 12 V	-12.11 V	
VBAT (V)	2.99 V	
5VSB (V)	5.26 V	
Shutdown Temperature	[Disabled]	

Managing The PC BIOS

CPU Warning Temperature

This field allows you to select an operating temperature range for your CPU. If the CPU temperature moves out of this range, any warning mechanism you have programmed into your system will be activated.

Current CPU Temp.

This field shows the current temperature for CPU 1.

Current CPU FAN Speed

This field shows you the present CPU Cooling FAN1 speed.

Current Chassis FAN Speed

This field shows you the present CPU Cooling FAN2 speed.

Vcore

This field and the files below show you the current system voltage

Shutdown Temperature

When the system reaches a certain maximum temperature the system will automatically shutdown.

3.10. Frequency/Voltage Control

Phoenix - AwardBIOS CMOS Setup Utility Frequency/Voltage Control		
CPU Clock Ratio	[8X]	Item Help
Auto Detect DIMM/PCI Clk	[Enabled]	Menu Level ▸
Spread Spectrum	[Disabled]	
CPU Clock	[100MHz]	

CPU Clock Ratio

This field can be used to adjust the FSB (Front Side Bus) ratio. The default (minimum adjustment) that can be made is X8. This shows the ratio range.

Auto Detect DIMM/PCI Clk

When "Enabled" is selected, the mainboard will detect the presence of devices on DIMM and PCI slots. When there is no device present on some of the PCI or DIMM connectors, the clock on the related DIMM and PCI slot will be disabled to reduce the Electro-Magnetic Interference (EMI).

Spread Spectrum

When Spread Spectrum is enabled, the EMI radiation on this mainboard will be reduced.

Managing The PC BIOS

CPU Clock

This field allows a timing combination for the CPU to be selected. There is a large range of possible combinations (+/- 1MHz to 132MHz). If **Default** is selected the BIOS will use the clock values for the CPU card.

3.11. Load Fail-Safe Defaults / Load Optimized Defaults

Phoenix - AwardBIOS CMOS Setup Utility	
<ul style="list-style-type: none">▶ Standard CMOS Features▶ Advanced BIOS Features▶ Advanced Chipset Features▶ Integrated Peripherals▶ Power Management Setup▶ PNP/PCI Configuration▶ PC Health Status	<ul style="list-style-type: none">▶ Frequency/Voltage Control<ul style="list-style-type: none">Load Fail-Safe DefaultsLoad Optimized DefaultsSet Supervisor PasswordSet User PasswordSave & Exit SetupExit Without Saving
Esc : Quit F9 : Menu in BIOS ← ↑ ↓ → : Select Item	
Load Fail-Safe / Optimized Defaults	

3.11.1. Load Fail-Safe Defaults

This option loads troubleshooting default values which are permanently stored on the BIOS ROM Chip. If you made changes to the BIOS settings and your system has become unstable, you can change it back to the default settings. If you have made many changes to the BIOS settings and you are not sure which setting is causing the problem then you should choose this option. This will load the minimal performance settings and stabilize your system.

3.11.2. Load Optimized Defaults

There is CMOS memory on the mainboard that can be used to store the system settings. If you don't know how to use the Award BIOS CMOS Setup Utility to select the settings, you may use this field to load the optimized defaults which are defined in the system BIOS. **Our engineer recommends the Optimized Defaults.** If this option is selected it will give a series of parameters that will ensure the reliability and performance of your PC.

If you lose your CMOS data or you don't know how to complete the setup procedure, you may use this option to load the Optimized default values from the BIOS default table.

If the CMOS data is corrupted, or if you selected some CMOS settings and find that the PC system becomes very unstable, you should try to load the optimized default values first and then re-configure the BIOS.

Managing The PC BIOS

3.12. Set Supervisor Password and User Password

Phoenix - AwardBIOS CMOS Setup Utility	
<ul style="list-style-type: none">▶ Standard CMOS Features▶ Advanced BIOS Features▶ Advanced Chipset Features▶ Integrated Peripherals▶ Power Management Setup▶ PNP/PCI Configuration▶ PC Health Status	<ul style="list-style-type: none">▶ Frequency/Voltage Control<ul style="list-style-type: none">Load Fail-Safe DefaultsLoad Optimized DefaultsSet Supervisor PasswordSet User PasswordSave & Exit SetupExit Without Saving
Esc : Quit F9 : Menu in BIOS ← ↑ ↓ → : Select Item	
Change / Set / Disable Password	

3.12.1. Set Supervisor Password

The "SUPERVISOR PASSWORD" is for you to control unauthorized access to your BIOS CMOS Setup or Booting into the your PC system. The Supervisor Password option is used together with the Security Option in section 3.5.

When "Setup" is selected in the Security Option:

If you want to change any BIOS setting, you will have to key-in the Supervisor Password so that you can start the BIOS CMOS Setup Utility and change the system setting.

When "System" is selected in Security Option:

Whenever you turn on the PC, it will request the user to enter the Password in order to boot up your system. Without the correct password, the PC system will stop and the operating system will not be loaded.

3.12.2. Set User Password

The User Password can be used to check the user's authority. However, this password entry is different from the "SUPERVISOR PASSWORD". The User Password has a different function to the "Supervisor Password" and the "Security Option" setup in Section 3.5:

A. When there is the password stored in "SUPERVISOR PASSWORD"

1. When "Setup" is selected in the Security Option:

When you use the "User Password" to log into the BIOS setup program, you can only view the BIOS settings, but you cannot change them. The only setting you can change is the "User Password" and you can also select "SAVE & EXIT SETUP" and "EXIT WITHOUT SAVING" from the main menu. (If you use

Managing The PC BIOS

the Supervisor Password to log into the PC system, you will have complete rights to all the BIOS settings.

2. When "System" is selected in Security Option:

When you turn on the PC system, it will request that you enter the Password. Without the correct password, the PC system will stop and the operating system won't be loaded.

B. When there is no password stored in "SUPERVISOR PASSWORD"

1. When "Setup" is selected in Security Option:

Users can use the "User Password" to log into the BIOS setup program, and they can change any of the BIOS settings.

2. When "System" is selected in Security Option:

When you turn on your PC, you will be requested to enter the Password. Without the correct password, the PC system will stop and the operation system will not be loaded.

3.13. Save & Exit Setup/Exit Without Saving

Phoenix - AwardBIOS CMOS Setup Utility	
<ul style="list-style-type: none">▶ Standard CMOS Features▶ Advanced BIOS Features▶ Advanced Chipset Features▶ Integrated Peripherals▶ Power Management Setup▶ PNP/PCI Configuration▶ PC Health Status	<ul style="list-style-type: none">▶ Frequency/Voltage ControlLoad Fail-Safe DefaultsLoad Optimized DefaultsSet Supervisor PasswordSet User PasswordSave & Exit SetupExit Without Saving
Esc : Quit F9 : Menu in BIOS ← ↑ ↓ → : Select Item	
Save Data to CMOS & Exit SETUP / Abandon all Data & Exit SETUP	

3.13.1. Save & Exit Setup

This option will save all the setup values to CMOS RAM and exit the SETUP utility. Move the selection bar to "SAVE & EXIT SETUP" and press the "Enter" key, then type "Y" and press the "Enter" key again. The values you have entered will be saved and all the information stored in the CMOS memory.

3.13.2. Exit Without Saving

This option will exits the setup utility without saving any of the values you changed in the CMOS RAM. If you do not want to save any of the changes, or settings you selected in the BIOS SETUP utility, move the selection bar to the "EXIT WITHOUT SAVING" option. Press the "Enter" key. Then press "Y".