

# **SQ594 Mainboard**

User's Manual

# User Notice

## Static Electricity Precaution

Static electricity can easily damage your SQ594 mainboard. By observing a few basic precautions can help safeguard against damage that could result in expensive repairs. Follow the simple measures below to protect your equipment from static electricity damage:

Keep the mainboard and other system components in their anti-static packaging until you are ready to install them.

Touch a grounded surface before you remove any system component from its protective anti-static packaging. Unpacking and installation should be done on a grounded, anti-static mat. The operator should be wearing an anti-static wristband, grounded at the same points as the anti-static mat.

After removing the mainboard from its original packaging, only place it on a grounded, anti-static surface component side up. Immediately inspect the board for damage. Due to shifting during shipping, it is suggested that the installer press down on all of the socket ICs to ensure they are properly seated. Do this only with the board placed on a firm flat surface.

During configuration and installation touch a grounded surface frequently to discharge any static electrical charge that may have built up in your body. The best precaution is to wear a grounded wrist strap. When handling the mainboard or an adapter card avoid touching its components. Handle the mainboard and adapter cards either by the edges or by the adapter card case mounting bracket.

The information presented in this publication has been carefully screened for reliability.

The manufacturer provides this manual “As is” with no warranties of any kind, either express or implied, including, but not limited to, the implied warranties or conditions of this product fitness for any particular purpose. In no event shall manufacturer be liable for any loss of profits, loss of business, loss of data, interruption of business, or indirect, special, incidental, or consequential damages of any kind, even if manufacturer has been advised of the possibility of such damages arising from any defect or error in this manual or product. The manufacturer has the right to change this specification without pre-notice.

Trademarks and product names appearing in this manual are may or may not be registered of their respective holders.



# Table of Contents

<b>1 INTRODUCTION.....</b>	<b>1-1</b>
1.1 HOW TO USE THIS MANUAL.....	1-1
1.2 ITEM CHECKLIST.....	1-1
<b>2 KEY FEATURES.....</b>	<b>2-1</b>
2.1 MAINBOARD LAYOUT.....	2-2
<b>3 INSTALLATION.....</b>	<b>3-1</b>
3.1 INSTALLATION PREVIEW.....	3-1
3.2 JUMPERS.....	3-1
3.3 EXPANSION SLOTS.....	3-1
3.4 CONNECTORS.....	3-1
3.5 INSTALLATION STEPS.....	3-2
<b>4 BIOS SETUP.....</b>	<b>4-1</b>
4.1 ENTERING SETUP.....	4-1
4.2 CONTROL KEYS.....	4-1
4.3 THE MAIN MENU.....	4-3
4.4 STANDARD CMOS SETUP MENU.....	4-5
4.5 BIOS FEATURES SETUP MENU.....	4-8
4.6 CHIPSET FEATURES SETUP MENU.....	4-11
4.7 POWER MANAGEMENT SETUP MENU.....	4-12
4.8 PCI CONFIGURATION SETUP MENU.....	4-14
4.9 INTEGRATED PERIPHERALS MENU.....	4-15
4.10 PASSWORD SETTING.....	4-17
4.11 IDE HDD AUTO DETECTION.....	4-18



# Introduction

## How to use this Manual

This manual provides information necessary for SQ594 mainboard and is organized into 4 chapters. Its purpose is to explain the installation procedures and operations of the mainboard as specified below.

Introduction : Manual information and checklist

Key Features : An overview of the specifications of this mainboard

Installation : Instructions on how to setup the mainboard

BIOS setup : BIOS software setup information

## Item Checklist

The SQ594 mainboard should contain followings tick(✓). Immediately, contact to your retailer if you discover any missing items, or any damage .

- The SQ594 mainboard
- This SQ594 user's manual
- 2 serial port ribbon cables attached to a mounting bracket
- 1 parallel ribbon cable attached to a mounting bracket
- 1 IDE ribbon cable
- 1 Floppy ribbon cable
- PS/2 mouse cable with mounting bracket (optional)
- Infrared module(optional)
- USB(2-port) cable with mounting bracket(optional)





# key Features

- ✧ **Processor:** The SQ594 supports Intel Pentium Processors P54C/P55C, AMD-K5 and Cyrix 6x86 Processors. The ZIF Socket 7 will support future Pentium Overdrives.
- ✧ **L2 Cache:** Standard package includes 256KB cache onboard. (512KB optional)
- ✧ **System memory:** Supports four 72-pin SIMM modules using 4MB, 8MB, 16MB, or 32MB for a maximum 128MB. Memory supported is both Fast Page Mode (FPM) and Extended Data Output (EDO). The memory must be 70ns (nano seconds) or faster.
- ✧ **Synchronous DRAM (SDRAM) memory DIMM Modules:** Two 168-pin DIMM memory modules are also featured on the SQ594 in addition to the four 72-pin SIMM modules. The DIMM module sizes can be 1Mx64, 2Mx64, or 4Mx64. The DIMM modules can be 3.3 or 5 volts and can be Fast Page Mode, EDO DRAM or 3.3V Synchronous DRAM (SDRAM) . The memory must be 60ns or faster. The SQ594 can support both SIMMs and DIMMs.
- ✧ **Intel Chipset:** Intel 82430VX PCIset as the core Chipset with a Winbond 83877F/AF super I/O (input/output) controller chip.
- ✧ **Expansion Slots:** Three 16-bit ISA slots, four 32-bit PCI slots. (Includes one shared)
- ✧ **Super Multi-I/O:** Two high-speed UART compatible serial ports and one parallel port with ECP and EPP compatibility. One FDD header supporting either 5.25" or 3.5"(1.2, 1.44 or 2.88MB) floppy drives without requiring an external I/O card. One fast IrDA TX/RX infrared port.
- ✧ **PCI Bus Master IDE Controller:** Onboard PCI Bus Master IDE controller with 2 ports to support 4 IDE devices. This controller supports PIO mode 3 and 4 with a data transfer rate up to 17MB per second. The Bus Master IDE DMA mode 2 transfer up to 22MB per second.
- ✧ **PCI BIOS:** With Green, Plug and Play, DMI, USB functions.
- ✧ **Universal Serial Bus:** Two standard USB headers supporting up to 48MHz and 127 peripheral devices . Optional USB cable set.
- ✧ **IrDA and PS/2 mouse:** Fast IrDA (Infrared) or on IrDA TX/RX module for wireless interface and PS/2 mouse connector.

# Mainboard Layout

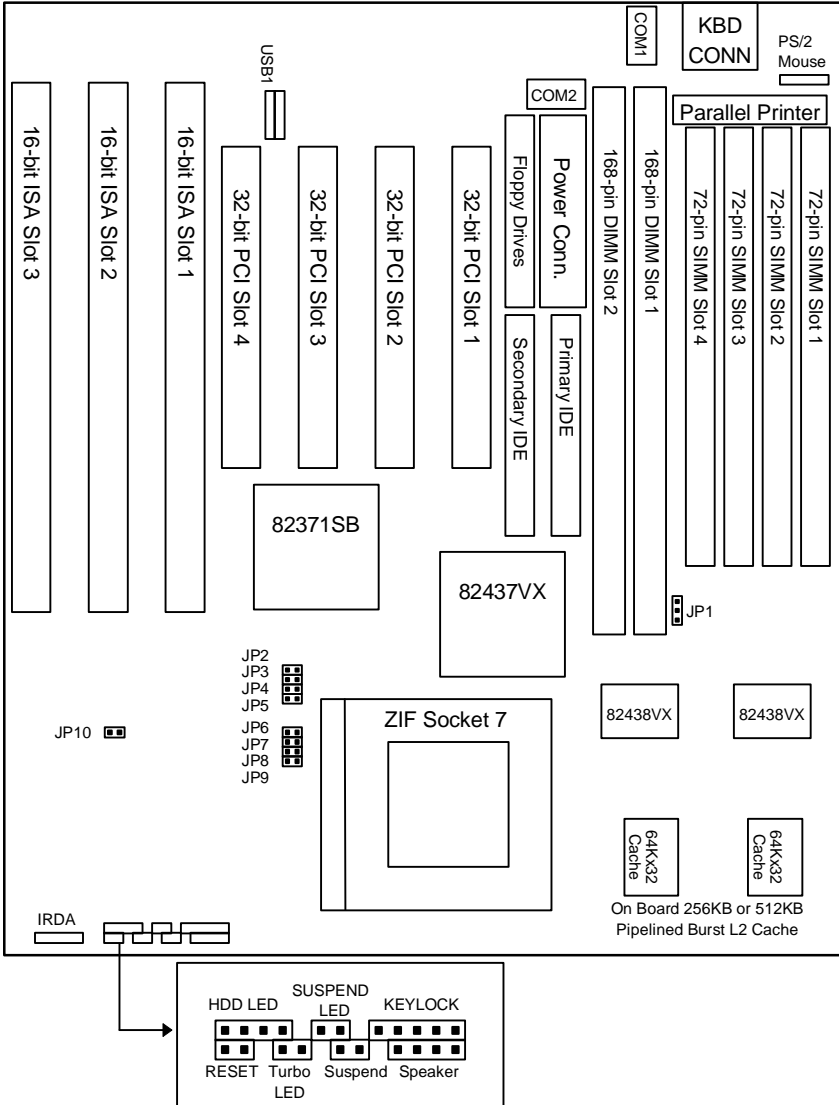

# Installation

## Installation Preview

Before you install the SQ594 mainboard into the system chassis, you may find it convenient to first configure the mainboard hardware. This section describes how to configure the jumper settings, install memory modules and how to attach the various system components. Before using your computer you must review the following 6 steps:

- ✌ Jumpers settings.
- ✌ Installation of DRAM memory modules.
- ✌ Installation of the CPU.
- ✌ Installation of IDE and I/O cables and the power supply connection.
- ✌ Installation of expansion cards.
- ✌ Setup of the system BIOS software.

## Jumpers:

- JP1            3.3V or 5V DIMM Voltage selection.
- JP6            CPU 3V Voltage regulator output selection.
- JP7            CPU 2V Voltage regulator output selection.
- JP8, JP9      CPU  $V_{\text{CORE}}$  3V/2V Voltage selection.
- JP10          CMOS RAM (Operation/Clear CMOS data).
- JP2, JP3      CPU external clock (Bus) frequency selection.
- JP4(= BF0) CPU (Bus) frequency ratio.
- JP5(= BF1) CPU (Bus) frequency ratio.

## Expansion Slots:

- SIMM Sockets    DRAM SIMM module sockets.
- DIMM Sockets    SDRAM/EDO/FP DIMM module sockets.
- ZIF Socket 7    Socket for Central Processing Unit (CPU).

ISA Slots 16-bit ISA Bus expansion slots.  
 PCI Slots 32-bit PCI Bus expansion slots.

## Connectors

Keyboard (J6)

Keybo

ard connector (5-pin).

PS/2 Mouse (J1)

PS/2

Mouse Header (5-pin).

Parallel Port (J3)

Paralle

l port connector (26-pin Block).

Serial Port (J8, J9)

Serial

ports COM1 & COM2 (10-pin Block).

Floppy Drive (J12)

Floppy

drive connector (34-pin Block)

Power Input (J10)

Power

connector (12-pin Block).

Primary IDE (J11)

Primar

y IDE connector (40-pin Block).

Secondary IDE (J13) Secondary IDE connector (40-pin Block).

USB Header (J18, J17) 2 USB ports USB1 & USB2 (5-pin).

IRDA (J29) IrDA connector (5-pin).

Key Lock (J20) Keyboard lock switch connector (5-pins).

Speaker (J21) Speaker connector (4-pin).

Suspend LED (J23) Suspend LED connector (2-pin).

Suspend Switch (J24) Suspend switch connector (2-pin).

HDD LED (J25) Hard Disk drive LED connector (4-pin).

Turbo LED (J26) Turbo LED connector (2-pin) .

Reset Switch (J28) Reset switch connector (2-pin).



**WARNING:** Do not apply power if the mainboard appears damaged or items are missing from the mainboard .

## Installation Steps

### Jumper Settings

You can configure the hardware options by setting jumper on the mainboard. A jumper is a set of two or more metal pins in a plastic base attached to the mainboard. A plastic “Jumper cap” with a metal (conductive) plate inside fits over two pins to create an electrical contact or short between them. This contact establishes a hardware setting and is referred to as a “closed” jumper setting. Some jumpers have two pins while others may have three or more. Jumpers are sometimes combined into sets called jumper blocks where all the jumpers in the block must be set together to establish a hardware setting. In this manual the jumper settings will be described as graphically using a (s)triangle always marking Pin 1. Those jumpers with two pins will be shown as closed and open. A jumper is referred to as closed by placing the plastic jumper cap over the two jumper pins and as open by removing the jumper cap. Some jumpers are oriented vertically and other horizontally with Pin 1 marked as (P1).

### Jumpers, Jumper Caps, and Jumper Blocks

Jumper cap	2-pin jumper	3-pin jumper
		

#### Setting 3-pin jumpers



Jumper Pins 1 & 2 are closed with a jumper cap



Jumper Pins 2 & 3 are closed with a jumper cap

#### Setting 2-pin jumpers



This jumper is closed with the jumper cap is placed over the 2 pins



This jumper is open with the jumper cap removed from the 2 pins

**WARNING:** Some pins are used for connectors or power sources. These are clearly marked separately from the jumpers listed in “Mainboard Layout”. Any improper placing of jumper caps over these connectors will result in damage to your motherboard.

### CPU Voltage Selection Jumpers (JP6, JP7, JP8, & JP9)

Intel & AMD Selection	JP6	JP7	JP8	JP9
P54C/K5 STD (3.135-3.6V)				
P54C/K5 VRE (3.4-3.6V)				
P55C (V <sub>I/O</sub> =3.38V) (V <sub>CORE</sub> =2.5V)				
P55C (V <sub>I/O</sub> =3.38V) (V <sub>CORE</sub> =2.8V)				

**WARNING:** JP8 and JP9 must always be open whether the voltage is set to 2.5V or 2.8V. This applies to both Intel P55C CPU and the Cyrix 6x86 CPU.



Cyrix 6x86 Selection	JP6	JP7	JP8	JP9
STD (3.15-3.6V)				
VRE (3.4-3.6V)				
2.5V (Future )				
2.8V (Future)				

**REMARK:** Effective April 24, 1996 Cyrix changed their previous part markings to their new markings (example: 028 into 3.52V(028)) for their nominal voltage specification of 3.52 volts(also known as the VRE spec.). The table below shows Cyrix old Vs new markings. Be sure that your mainboard voltage jumper settings are set accordingly.

Previous Marking	Previous Recommended Nominal Voltage	New Marking	New Recommended Nominal Voltage
Blank	3.3V	3.3V or 3.52V	3.52V
016	3.3V	N/A	N/A
028	3.52V	3.52V(028)	3.52V

### CMOS Settings(Operation/Clear CMOS Data) (JP10)

The JP10 allows you to clear the SQ594 mainboard CMOS memory and Real Time Clock (RTC) data. The CMOS memory maintains the system configuration information and RTC provides the system with the date and time. Make sure this jumper is open for normal operation.

Normal (Default)	Clear CMOS
	

#### Clear CMOS procedure :





To clear the stored CMOS data, do the following :

































1) the system turned off, ⇒ 2) close JP10 ⇒ 3) Open JP10 ⇒ 4) ⇒ Power on ⇒ 5) Re-setup the BIOS (refer to enter the BIOS setup menu, hold down <DEL> during the system boot sequence).

















**NOTICE:** Under some circumstances it is possible that the CMOS configuration settings may be lost or corrupted causing the system to malfunction. This is not a serious problem. If this happens, run the BIOS setup utility and re-enter your configuration settings. When you restart the computer, the system should work normally.

### CPU Speed Selection (JP2, JP3, JP4, JP5)

The system speed depends upon the frequency of CLOCK GENERATOR which is determined by jumpers. These jumpers tell the system what speed to run at. Currently, this mainboard speed range is from 75MHz to 200MHz. The CPU input frequency must match the frequency of CLOCK GEN or it will cause the system to malfunction. For example, setting a 75MHz CPU to run at 90MHz will cause the system to malfunction.

Intel/AMD CPU Setting	JP2	JP3	JP4	JP5
75MHz				

90MHz				
100MHz				
120MHz				
133MHz				
150MHz				
166MHz				
180MHz				
200MHz				

Cyrix 6X86 Setting	JP2	JP3	JP4	JP5
100MHz(=P120+)				
110MHz(=P133+)				
120MHz(=P150+)				
133MHz(=P166+)				

**NOTICE:** When installing the CPU into the CPU socket, be sure that PIN 1 of the CPU is in the same corner as the PIN 1 of socket. The CPU is an extremely sensitive electric component and can be easily damaged by static electricity.



## Expansion Slots

The SQ594 has 7 expansion Slots On-board, there are 3 16-bit ISA, and 4 32-bit PCI expansion Slots. (Includes one share)

### Installation Procedure:



To install expansion cards, please read the expansion card's documentation for instructions.

**NOTICE:** Some expansion cards require an IRQ to work and may cause a conflict. There are a total of 16 IRQs but only 6 are free for expansion cards. In case of a conflict please contact the system manufacturer for technical support.

1. There are two types of ISA expansion cards, design-Legacy and P-n-P (Plug & Play). For Legacy cards you must set the card's jumpers manually. For Plug and Play cards, your system will arrange the IRQs and DMAs automatically. You can verify the IRQ allocation either by using Microsoft's Diagnostic (MSD.EXE) utility which is in the Windows directory or through the Windows 95 resources menu.
2. An IRQ is automatically assigned to PCI expansion cards. All of the PCI slots on the mainboard use an interrupt. Be sure that the jumpers on your PCI cards are set to interrupt A.

## System Memory

**IMPORTANT:** The SQ594 System memory can support 5V Fast Page Mode or EDO DIMM, JP1 is default set to 3.3V, please reset it to 5V location once you are using 5V DIMM.

3.3V DIMM (Default)	5V DIMM
	

### System Memory - SIMM Slots (DRAM)

You can configure the system memory size in a variety of ways by in using different combinations of the four 72-pin DRAM SIMM modules. The memory must be 70ns (nano seconds) or faster using either Fast Page Mode or Extended Data Output (EDO) types. The memory chart below shows the different memory size combinations available. Please pay attention to the following restrictions:

- 1) You must use one pair of sockets at a time in sequence (i.e. SIMM1 and SIMM2, or all four sockets at once). Each pair of modules must be the same size and speed and may be either single sided or double-sided.
- 2) Module sizes: Single-side SIMMs: 4MB, 16MB
- 3) Double-side SIMMs: 8MB, 32MB

**Memory Module Combinations**

<b>Total Memory (Slot 1-4)</b>	<b>Bank 0 (Slot 1 &amp; 2)</b>	<b>Bank 1 (Slot 3 &amp; 4)</b>
8MB	4MBx2	None
16MB	8MBx2	None
32MB	16MBx2	None
64MB	32MBx2	None
8MB	None	4MBx2
16MB	None	8MBx2
32MB	None	16MBx2
64MB	None	32MBx2
16MB	4MBx2	4MBx2
24MB	4MBx2	8MBx2
40MB	4MBx2	16MBx2
72MB	4MBx2	32MBx2
24MB	8MBx2	4MBx2
32MB	8MBx2	8MBx2
48MB	8MBx2	16MBx2
80Mb	8MBx2	32MBx2
40MB	16MBx2	4MBx2
48MB	16MBx2	8MBx2
64MB	16MBx2	16MBx2
96MB	16MBx2	32MBx2
72MB	32MBx2	4MBx2
80MB	32MBx2	8MBx2
96MB	32MBx2	16MBx2
128MB	32MBx2	32MBx2

## Installation Procedure for System Memory

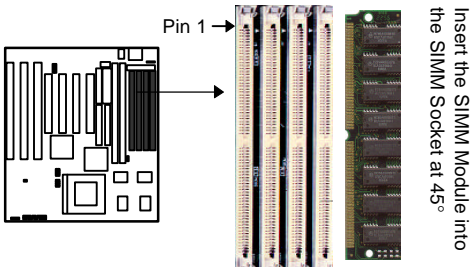

1. PIN1 of the SIMM module must match with the PIN1 of the SIMM socket.
2. The module will only insert into the socket one way. An orientation cut-out will prevent you from inserting it the wrong way.
3. Insert the DRAM module into the SIMM socket at a 45 degree angle. If Pin 1 of the SIMM does not line up with Pin 1 of the socket, the SIMM will not insert into the socket. After inserting the SIMM module completely into socket, push the SIMM module into a vertical position.
4. The module should click into place with the retaining clips at each end of the socket snapping behind the module to secure it.
5. To release the memory module push both retaining clips outwards and carefully rock the module forward.

**IMPORTANT:** Do not use SIMM modules that use an extra TTL chip to convert the memory module from asymmetric to symmetric.

### System Memory - DIMM Sockets (SDRAM)

The SQ594 mainboard features two 168-pin DIMM modules with each DIMM supporting 8MB to 32MB of Synchronous DRAM using 1Mx64, 2Mx64 and 4Mx64 DIMM modules (Asymmetrical single-and double -sided). The DRAM interfaces on a 64-bit wide data path and supports unbuffered Fast Page Mode, Extended Data Out(EDO) 3.3V/5V DRAM 60ns or faster. Also supported is 3.3 volts 66.67MHz unbuffered Synchronous DRAM (SDRAM). EDO DRAM DIMM and SDRAM DIMM are defined as below:

Table 1 : EDO/FP DRAM DIMM Configurations :

Type	Capacity	Organization	EDO DRAM	Clock Speed
168-pin 3.3/5V unbuffered EDO DRAM DIMM w/ serial Presence Detect	8MB	1Mx64	1Mx16 1 bank (DIMM1)	60ns

168-pin 3.3/5V unbuffered EDO DRAM DIMM w/ serial Presence Detect	16MB	2Mx64	1Mx16 2 banks (DIMM 1& 2)	60ns
168-pin 3.3/5V unbuffered EDO DRAM DIMM w/ serial Presence Detect	16MB	2Mx64	2Mx8 1 bank (DIMM 1)	60ns
168-pin 3.3/5V unbuffered EDO DRAM DIMM w/ serial Presence Detect	32Mb	4Mx64	2Mx8 2 banks (DIMM1 & 2)	60ns

Table 2: SDRAM DIMM Configurations:

Type	Capacity	Organization	SDRAM	Clock Speed
168-pin 3.3V unbuffered SDRAM DIMM with serial Presence Detect	8MB	1Mx64	1Mx16 1 bank (DIMM1)	66.67MHz
168-pin 3.3V unbuffered SDRAM DIMM with serial Presence Detect	16MB	2Mx64	1Mx16 2 banks(DIMM 1& 2)	66.67MHz
168-pin 3.3V unbuffered SDRAM DIMM with serial Presence Detect	16MB	2Mx64	2Mx8 1 bank (DIMM 1)	66.67MHz
168-pin 3.3V unbuffered SDRAM DIMM with serial Presence Detect	32Mb	4Mx64	2Mx8 2 banks (DIMM1 & 2)	66.67MHz

### Installation Procedure (SDRAM/EDO/FP DRAM)

1. PIN1 of the DIMM module must match with the PIN1 of the DIMM socket.
2. The module will only insert into the socket one way. An orientation cut-out will prevent you from inserting it the wrong way.

3. Insert the SDRAM module into the DIMM socket at a 90 degree angle. If Pin 1 of the DIMM does not line up with Pin 1 of the socket, the DIMM will not insert into the socket. After inserting the DIMM module completely into socket, push up on the socket latches securing the DIMM into place.
4. To release the memory module push both latches down and carefully rock the module forward.

**IMPORTANT:** Do not use DIMM which use an extra TTL chip to convert the memory module from asymmetric to symmetric.

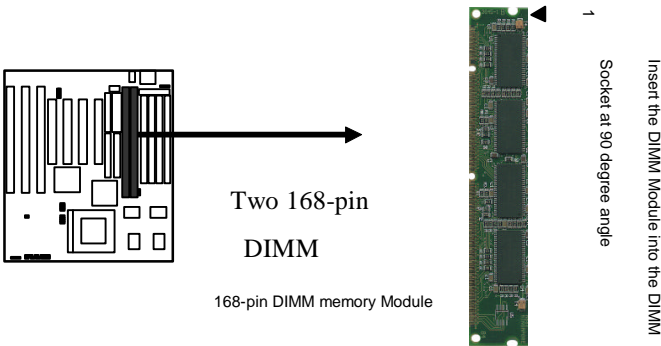

### ZIF Socket 7 for Central Processing Unit(CPU)

The SQ594 comes with a 321-pin ZIF Socket 7 for installing the CPU. The Socket 7 will also support future Pentium up-grade processors. It is strongly recommended that a heatsink and CPU cooling fan be used to prevent the CPU from overheating. (Tip) Applying a thermal of jelly between the CPU and the heatsink/fan will further cool the CPU.

### Installation Procedure(CPU)

To install a CPU, remember to take careful precaution against static electric discharge. The basic procedure is as follows:

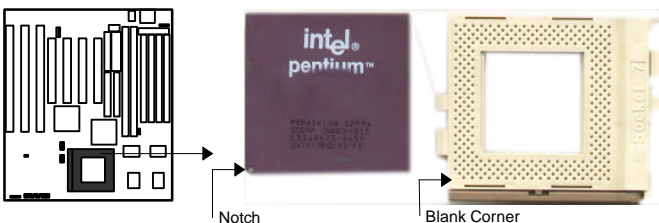

**IMPORTANT:** you must set jumpers JP6, JP7, JP8 & JP9 to correct CPU Voltage.

1. Turn off your system and disconnect the power source.
2. Remove the existing CPU from the ZIF socket by pulling the ZIF lever upwards at a 90-degree angle.

3. Insert the CPU with the correct orientation as below shown. Use the notched corner of the CPU as your guide. The notch in the corner of the CPU should correspond with PIN1 of the ZIF socket (Notice: Pin 1 is the blank corner of the ZIF socket with one pin hole missing).
4. Once the CPU is inserted close the socket's lever.

**WARNING:** Without a fan, the CPU can overheat and will cause damage to both the CPU and the SQ594 motherboard.

## Connectors

### Keyboard (J6)

This connector supports a standard 101 enhanced IBM-compatible keyboard.

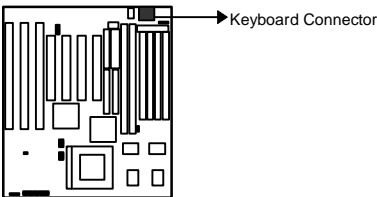

### PS/2 Mouse header(J1)

This SQ594 mainboard provides a default PS/2 mouse header that supports an optional PS/2 mouse connector cable & bracket

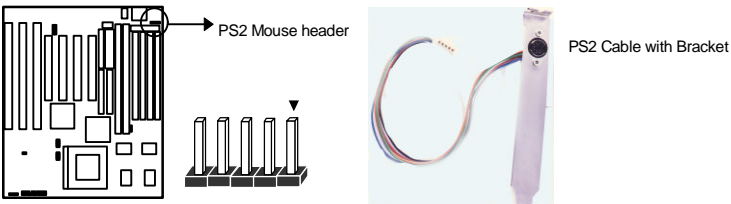

### Parallel Port (J3)

This connector supports a parallel port ribbon cable and mounting bracket. Connect the ribbon cable to this connector and mount the bracket to the back of the case.

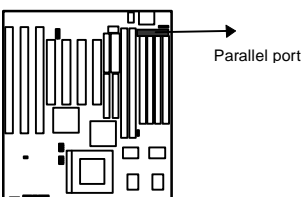

**WARNING:** When you connect the ribbon cable to this port, you must ensure PIN 1 of the cable matches PIN 1 of the connector.

### Serial Ports (J8, J9)

These connectors support two serial port ribbon cables (Com1 & Com2). Connect the ribbon cable to these connectors and mount the bracket to the back of the case.

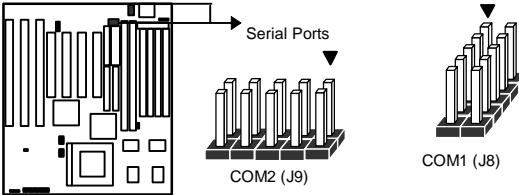

**WARNING:** When you connect the ribbon cable to this port, you must ensure PIN 1 of the cable matches PIN 1 of the connector.

### Floppy Driver (J12)

This connector supports the floppy drive via a floppy drive ribbon cable. The ribbon cable can support one to two floppy drives.

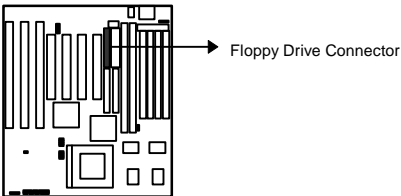

**WARNING:** When you connect the ribbon cable to this port, you must ensure PIN 1 of the cable matches PIN 1 of the connector.

### Power Input (J10)

This connector supports a standard power supply. Make sure that the power cord is unplugged when you connect it. There are two power plugs, each with six colored wires. The black wires on each plug must be placed together in the middle and then pressed into the power connector on the mainboard.

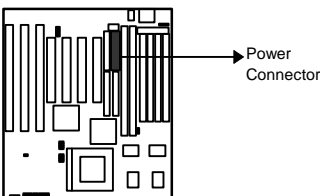

## Primary IDE (J11)

This connector supports two primary IDE devices via a ribbon cable. When two IDE devices are installed using the primary IDE connector make sure that the second IDE device is adjusted to *slave mode* as instructed in the device's manual.

**WARNING:** When you connect the ribbon cable to this port, you must ensure PIN 1 of the cable matches PIN 1 of the connector.

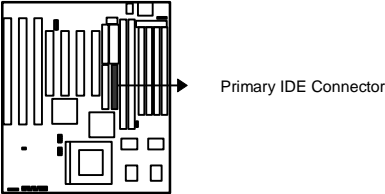

## Secondary IDE (J13)

This connector supports two secondary IDE devices via a ribbon cable. When two IDE devices are installed using the secondary IDE connector make sure that the second IDE device is adjusted to *slave mode* as instructed in the device's manual.

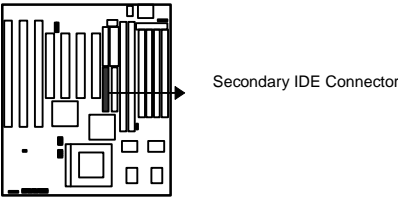

**WARNING:** When you connect the ribbon cable to this port, you must ensure PIN 1 of the cable matches PIN 1 of the connector.

## Universal Serial Bus (USB) Header (J17/J18)

This SQ594 mainboard has two USB headers onboard. USB devices provide a more convenient operating environment and improve data transferring capacity. True Plug-and-Play, this new bus technology will support over 127 different peripherals through a Hub.

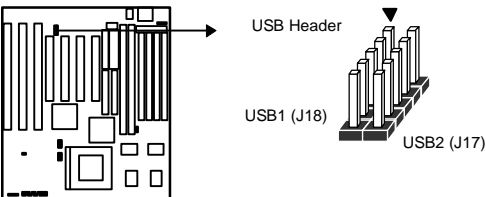

**WARNING:** When you connect the cable to this port, you must ensure PIN 1 of the cable matches PIN 1 of the connector.



### IrDA connector (J29)

The SQ594 mainboard offers both Fast IrDA and IrDA functions. IrDA is the wireless transmitting and receiving data via an optional infrared module. The efficient operating distance is 100CM and the data transfer rates for IrDA is 1.44M KB/sec and Fast IrDA , 4M KB/sec.

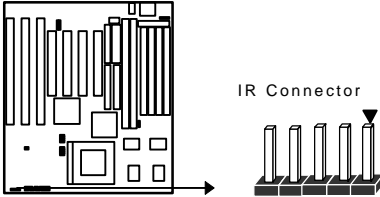

**IMPORTANT:** You must configure this feature through the BIOS by selecting whether UART2 is allocated for use by COM2 or for IrDA. The IR module is supported by the mainboard via a 5-pin connector and ribbon cable.

### Key Lock (5-pin ) (J20)

This connector supports the case-mounted switch for locking the keyboard for security purposes.

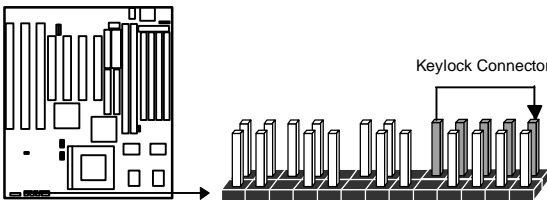

### Speaker (4-pin) (J21)

This connector supports the case-mounted speaker.

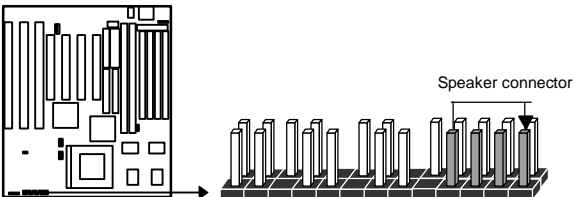

### Suspend LED (2-pin ) (J23)

This connector supports the case-mounted Green function LED.

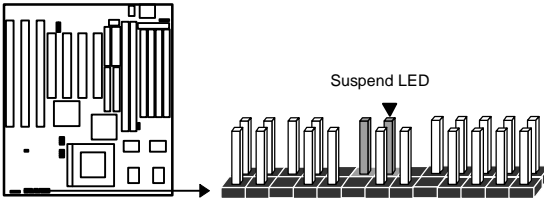

### Suspend Switch (2-pin)(J24)

This connector supports the case-mounted suspend switch allowing you to manually place the system into a suspend mode or “Green” mode. During Green mode, the system activity will be decreased to save energy when the system is not in use. If you want to use this feature, in the Power Management Setup of the BIOS should be turn on.

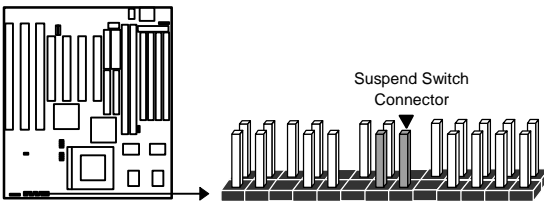

### HDD LED (4-pin)(J25)

This connector supports the hard disk activity indicator light on the case.

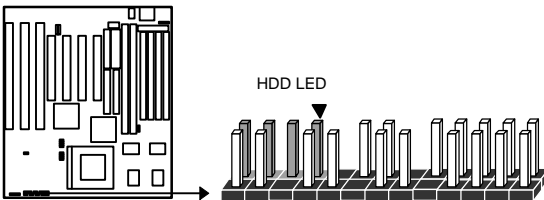

### Turbo LED (2-pin)(J26)

This connector supports the turbo LED. It will always be on because the mainboard’s turbo function is always on.

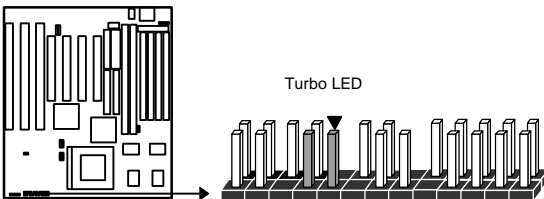

**Reset Switch (2-pin) (J28)**

This connector supports the case-mounted reset. It is advised that the reset switch be used for rebooting the system in order to extend the life of the system's power supply.

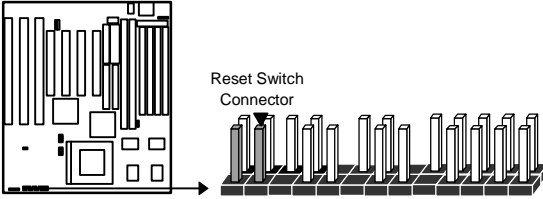



# BIOS Setup

The Award's BIOS ROM has a built-in Setup program that allows users to modify the basic system configuration. This type of information is stored in battery-backup RAM (CMOS RAM) so that it retains the Setup information when the power is turned off.

## Entering Setup

Power on the computer, the below message will appear briefly at the bottom of the screen during the POST (Power On Self Test), press <Del> key or simultaneously press <Ctrl>, <Alt>, and <Esc> keys.

Press **DEL** to enter SETUP, **ESC** to skip memory test

If the message disappears before you respond and you still wish to enter Setup, restart the system to try again by turning it OFF then ON or pressing the "RESET" button on the system case. You may also restart by simultaneously pressing <Ctrl>, <Alt>, and <Delete> keys. If you do not press the keys at the correct time and the system does not reboot, an error message will be displayed at the bottom of the screen and you will again be asked to,

Press **F1** to continue, **DEL** to enter SETUP

## Control Keys

<↑> , <↓>	Move to previous or next item
<←> , <→>	Move to the item in the left or right hand
<Esc>	Main Menu – Quit and not save changes into CMOS Status Page Setup Menu and Option Page Setup Menu -- Exit current page and return to Main Menu
<PgUp> / <+>	Increase the numeric value or make changes
<PgDn> / <->	Decrease the numeric value or make changes
<F1>	General help, only for Status Page Setup Menu and Option Page Setup Menu
Shift-<F2>	Change color from total 16 colors. F2 to select color forward, (Shift) F2 to select color backward
<F5>	Restore the previous CMOS value from CMOS, only for Option Page Setup Menu
<F7>	Load the Setup default , only for Option Page Setup Menu
<F10>	Save all the CMOS changes, only for Main Menu
<F3><F4> <F8><F9>	Reserved

## **Getting Help**

### **Main Menu**

The on-line description of the highlighted setup function is displayed at the bottom of the screen.

### **Status Page Setup Menu/Option Page Setup Menu**

Press F1 to pop up a small help window that describes the appropriate keys to use and the possible selections for the highlighted item. To exit the Help Window press <F1> or <Esc>.

## The Main Menu

Once you enter Award BIOS CMOS Setup Utility, the Main Menu (Figure 1) will appear on the screen. The Main Menu allows you to select from ten setup functions and two exit choices. Use arrow keys to select among the items and press <Enter> to accept or enter the sub-menu.

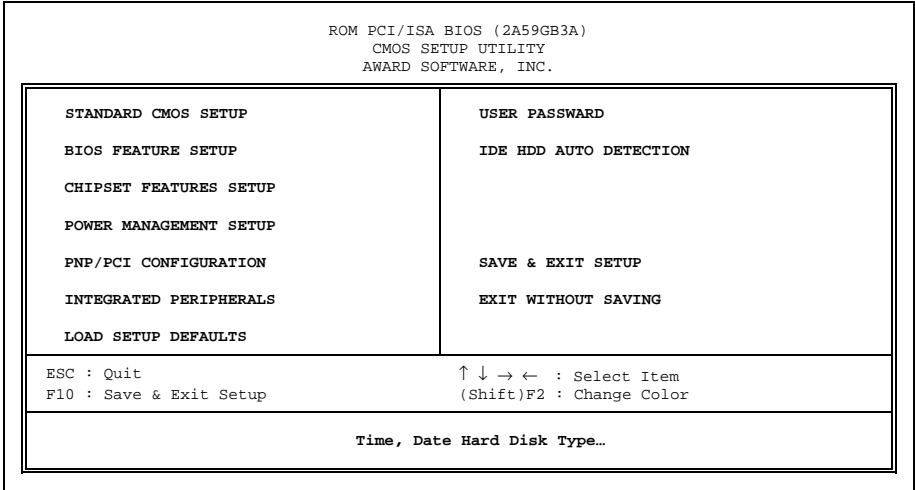

Figure 1

### Standard CMOS setup

This setup page includes all the items of standard CMOS setup features.

### BIOS features setup

This setup page includes all the items of Award special enhanced features.

### Chipset features setup

This setup page includes all the items of Chipset special features.

### Power Management setup

This category determines how much power consumption for system after selecting.

### PNP/PCI Configuration

This category specifies all the items of PCI/ISA devices' resources configuration and assignment.

## **Load setup defaults**

Setup defaults indicates the values required by the system for the maximum performance.

## **Integrated peripherals**

This setup page includes all the items of peripherals I/O setup features.

## **User Password**

Change, set, or disable password. It allows you to limit access to the system and Setup, or just to Setup.

## **IDE HDD auto detection**

Automatically configure hard disk parameters.

## **Save & exit setup**

Save CMOS value changes to CMOS and exit setup.

## **Exit without save**

Abandon all CMOS value changes and exit setup.



# Standard CMOS Setup Menu

The items in Standard CMOS Setup Menu are divided into 10 categories. Each category includes no, one or more than one setup items. Use the arrow keys to highlight the item and then use the <PgUp> or <PgDn> keys to select the value you want in each item.

ROM PCI/ISA BIOS (2A59GB3A)								
STANDARD CMOS SETUP								
AWARD SOFTWARE, INC.								
Date (mm:dd:yy) : Sun, <b>May 12 1996</b>								
Time (hh:mm:ss) : <b>10 : 10 : 00</b>								
HARD DISKS	TYPE	SIZE	CYLS	HEAD	PRECOMP	LANDZ	SECTOR	MODE
Primary Master	: <b>Auto</b>	0	0	0	0	0	0	<b>AUTO</b>
Primary Slave	: <b>Auto</b>	0	0	0	0	0	0	<b>AUTO</b>
Secondary Master	: <b>Auto</b>	0	0	0	0	0	0	<b>AUTO</b>
Secondary Slave	: <b>Auto</b>	0	0	0	0	0	0	<b>AUTO</b>
Drive A : <b>1.44MB, 3.5 in.</b>				Base Memory: 640K				
Drive B : <b>None</b>				Extended Memory: 31744K				
Video : <b>EGA/VGA</b>				Other Memory: 384K				
Halt On : <b>All Errors</b>				Total Memory: 32768K				
ESC : Quit			↑ ↓ → ← : Select Item			PU/PD/+/- : Modify		
F1 : Help			(Shift)F2 : Change Color					

Figure 2

## Date

The date format is <day>, <date> <month> <year>. Press <F3> to show the calendar.

day	The day of week, from Sun to Sat, determined by the BIOS, is read only
date	The date, from 1 to 31 (or the maximum allowed in the month), can key in the numerical / function key
month	The month, Jan through Dec.
year	The year, depend on the year of BIOS

## Time

The time format is <hour> <minute> <second>. which accepts both function key or numerical key The time is calculated based on the 24-hour military-time clock. For example, 1 p.m. is 13:00:00.

## Hard Disks

The categories identify the types of hard disks that have been installed in the computer. There are 45 predefined types, 1 user definable type and 1 Auto type. The Auto Type can auto configure your hard disks.

### Primary Master/Slave and Secondary Master/Slave

There are 4 items in this categories to identify the types of 2 hard disk channel that have been installed in the computer.

Press PgUp/<+> or PgDn/<-> to select a numbered hard disk type or type the number and press <Enter>. Note that the specifications of your drive must match with the drive table. The hard disk will not work properly if you enter improper information for this category. If your hard disk drive type is not matched or listed, you can use User Type to define your own drive type manually.

If you select User Type, related information is asked to be entered to the following items. Enter the information directly from the keyboard and press <Enter>. This information should be provided in the documentation from your hard disk vendor or the system manufacturer.

CYLS.	number of cylinders
HEADS	number of heads
PRECOMP	write precom
LANDZON E	landing zone
SECTORS	number of sectors
MODE	HDD access mode

If the controller of HDD interface is ESDI, the selection shall be “Type 1”.

If the controller of HDD interface is SCSI, the selection shall be “None”.

If the controller of HDD interface is CD-ROM, the selection shall be “None”.

If a hard disk has not been installed select NONE and press <Enter>.

## Drive A/B type

The category identifies the types of floppy disk drive A or drive B that have been installed in the computer.

None	No floppy drive installed
360K, 5.25 in	5-1/4 inch PC-type standard drive; 360 kilobyte capacity
1.2M, 5.25 in	5-1/4 inch AT-type high-density drive; 1.2 megabyte capacity
720K, 3.5 in	3-1/2 inch double-sided drive; 720 kilobyte capacity
1.44M, 3.5 in	3-1/2 inch double-sided drive; 1.44 megabyte capacity
2.88M, 3.5 in	3-1/2 inch double-sided drive; 2.88 megabyte capacity

## Video

The category selects the type of adapter used for the primary system monitor that must match your video display card and monitor. Although secondary monitors are supported, you do not have to select the type in Setup.

You have two ways to boot up the system:

When VGA as primary and monochrome as secondary, the selection of the video type is "VGA Mode".

When monochrome as primary and VGA as secondary, the selection of the video type is "Monochrome mode".

EGA/VG A	Enhanced Graphics Adapter/video Graphics Array. For EGA, VGA, SEGA, or PGA monitor adapters.
CGA 40	Color Graphics Adapter, power up in 40 column mode
CGA 80	Color Graphics Adapter, power up in 80 column mode
MONO	Monochrome adapter, includes high resolution monochrome adapters

## Halt on

The category determines whether the computer will stop if an error is detected during power up.

No errors	Whenever the BIOS detects a non-fatal error the system will be stopped and you will be prompted.
All errors	The system boot will not be stopped for any error that may be detected.
All, But Keyboard	The system boot will not stop for a keyboard error; it will stop for all other errors.
All, But Diskette	The system boot will not stop for a disk error; it will stop for all other errors.
All, But Disk/Key	The system boot will not stop for a keyboard or disk error; it will stop for all other errors.

## Memory

The category is display-only which is determined by POST (Power On Self Test) of the BIOS.

### Base Memory

The POST of the BIOS will determine the amount of base (or conventional) memory installed in the system. The value of the base memory is typically 512K for systems with 512K memory installed on the motherboard, or 640K for systems with 640K or more memory installed on the motherboard.

### Extended Memory

The BIOS determines how much extended memory is present during the POST. This is the amount of memory located above 1MB in the CPU's memory address map.

### Other Memory

This refers to the memory located in the 640K to 1024K address space. This is memory that can be used for different applications. DOS uses this area to load device drivers to keep as much base memory free for application programs. Most use for this area is Shadow RAM.

## Total Memory

System total memory is the sum of base memory, extended memory, and other memory.

## BIOS Features Setup Menu

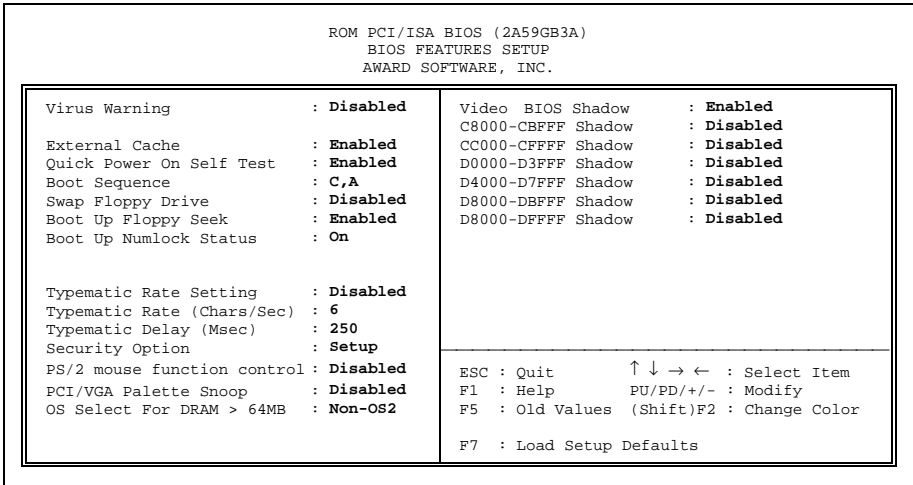

Figure 3

## Virus Warning

This category flashes on the screen. During and after the system boots up, any attempt to write to the boot sector or partition table of the hard disk drive will halt the system and the following error message will appear, in the mean time, you can run an anti-virus program to locate the problem.

**! WARNING !**  
 Disk boot sector is to be modified  
 Type "Y" to accept write or "N" to abort write  
 Award Software, Inc.

Enabled	Activates automatically when the system boots up causing a warning message to appear when anything attempts to access the boot sector or hard disk partition table.
Disabled	No warning message to appear when anything attempts to access the boot sector or hard disk partition table.

Note: This function is available only for DOS and other OSes that do not trap INT13.

## CPU External Cache

The default value is Enable.

## Quick Power On Self Test

This category speeds up Power On Self Test (POST) after you power on the computer. If it is set to Enable, BIOS will shorten or skip some check items during POST.

## Boot Sequence

This category determines which drive computer searches first for the disk operating system (i.e., DOS).

C,A	System will first search for hard disk drive then floppy disk drive.
A,C	System will first search for floppy disk drive then hard disk drive.
CDROM M	System will boot from CDROM.

## Swap Floppy Drive

This category allows you to swap two floppy disk drive for reading or writing data. When enabled the BIOS swaps floppy disk drive assignments, so that Drive A becomes Drive B, and Drive B becomes A.

## Boot Up Floppy Seek

During POST, BIOS will determine if the floppy disk drive installed is 40 or 80 tracks. 360K type is 40 tracks while 720K, 1.2M and 1.44M are all 80 tracks.

Enabled	BIOS searches for floppy disk drive to determine if it is 40 or 80 tracks. Note that BIOS can not tell from 720K, 1.2M or 1.44M drive type as they are all 80 tracks.
Disable d	BIOS will not search for the type of floppy disk drive by track number. Note that there will not be any warning message if the drive installed is 360K.

## Boot Up NumLock Status

Keypad is number keys when it is on and arrow keys when it is off.

## Typematic Rate Setting

Enabled	Enable typematic rate and typematic delay programming
Disabled	Disable typematic rate and typematic delay programming. The system BIOS will use default value of this 2 items and the default is controlled by keyboard.

## Typematic Rate (Chars/Sec)

It controls the speed at which the system registers repeated keystrokes. The range is from 6 to 30 characters per second.

## Typematic Delay (Msec)

It controls the time between the display of the first and second characters. There are four delay rates: 250ms, 500ms, 750ms and 1000ms.

250	250 msec
500	500 msec
750	750 msec
1000	1000 msec

## Security Option

This category allows you to limit access to the system and Setup, or just to Setup.

System	The system will not boot and access to Setup will be denied if the correct password is not entered at the prompt.
Setup	The system will boot, but access to Setup will be denied if the correct password is not entered at the prompt.

**Note:** To disable security, select PASSWORD SETTING at Main Menu and then you will be asked to enter password. Do not type anything and just press <Enter>, it will disable security. Once the security is disabled, the system will boot and you can enter Setup freely.

## PS/2 mouse function control

This category allows you to Enable or disable PS/2 Mouse function.

Enabled	Enable PS/2 mouse function
Disabled	Disable PS/2 mouse function

### **PCI/VGA Palette Snoop**

Some display cards which are non-standard VGA (such as graphics accelerators or MPEG Video Cards) may not show colors properly. This setting enabled should fix this problem.

### **OS select for DRAM > 64MB**

When using OS/2 operating systems with installed DRAM of greater than 64MB, you have to enable this option.

### **Video BIOS Shadow**

It determines whether video BIOS will be copied to RAM, however, it is optional from Chipset design. Video Shadow will increase the video speed.

### **C8000 - DFFFF Shadow**

These categories determine whether other expansion cards' ROM BIOS will be copied to Main memory by 16K byte or 32K byte per/unit and the size depends on Chipset. Which segment should be chose depending on cards ' ROM BIOS address decoding and chip's size.



# Chipset Features Setup Menu

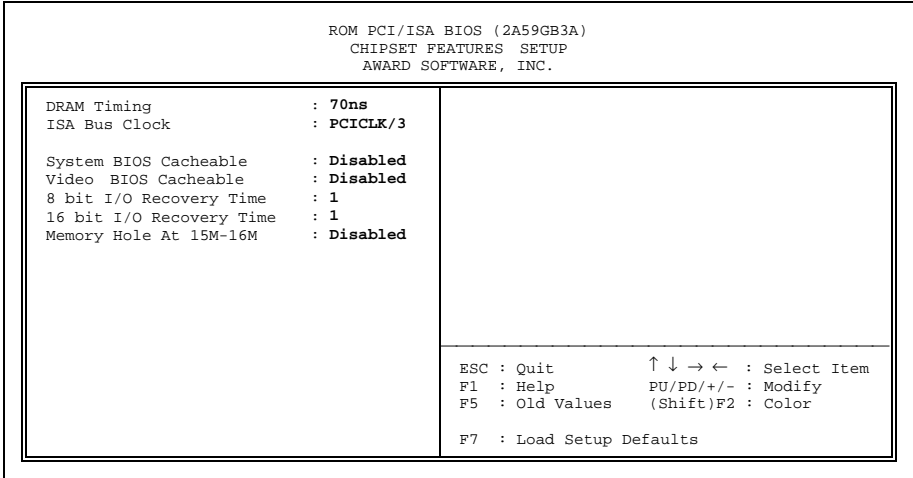

Figure 4

## ISA Bus Clock

Determine the clock rate of ISA bus.

## System BIOS Cacheable

Define whether or not the System area to be cached by the on board cache RAM

## Video BIOS Cacheable

Define whether or not the Video BIOS area to be cached by the on board cache RAM

## 8 Bit I/O Recovery Time

Select recovery time for 8 bit I/O

## 16 Bit I/O Recovery Time

Select recovery time for 16 bit I/O

## Memory Hole At 15M-16M

For special old ISA card

## Power Management Setup Menu

This category determines how much power consumption for system after selecting below items.

ROM PCI/ISA BIOS (2A59GB3A)	
POWER MANAGEMENT SETUP	
AWARD SOFTWARE, INC.	
Power Management : <b>Disable</b>	** Power Down & Resume Events **
PM Control by APM : <b>Yes</b>	IRQ3 (COM 2) : <b>OFF</b>
Video Off Method : <b>V/H SYNC+Blank</b>	IRQ4 (COM 1) : <b>OFF</b>
Modem Use IRQ : <b>3</b>	IRQ5 (LPT 2) : <b>OFF</b>
Doze Mode : <b>Disable</b>	IRQ6 (Floppy Disk) : <b>OFF</b>
Standby Mode : <b>Disable</b>	IRQ7 (LPT1) : <b>OFF</b>
Suspend Mode : <b>Disable</b>	IRQ9 (IRQ2 Redir) : <b>OFF</b>
HDD Power Down : <b>Disable</b>	IRQ10 (Reserved) : <b>OFF</b>
** Wake Up Events In Doze & Standby **	IRQ11 (Reserved) : <b>OFF</b>
IRQ3 (Wake-Up Event) : <b>OFF</b>	IRQ12 (PS/2 Mouse) : <b>OFF</b>
IRQ4 (Wake-Up Event) : <b>OFF</b>	IRQ13 (Coprocessor) : <b>OFF</b>
IRQ8 (Wake-Up Event) : <b>OFF</b>	IRQ14 (Hard Disk) : <b>OFF</b>
IRQ12 (Wake-Up Event) : <b>OFF</b>	IRQ15 (Reserved) : <b>OFF</b>
	ESC : Quit                   ↑↓←→ : Select Item
	F1 : Help                    PU/PD/+/- : Modify
	F5 : Old Values           (Shift)F2 : Color
	F7 : Load Setup Defaults

Figure 5

## Power Management

Options	Descriptions
1. Disable	Global Power Management will be disabled
2. User Define	Users can configure their own power management
3. Min Saving	Pre-defined timer values are used such that all timers are in their MAX value
4. Max Saving	Pre-defined timer values are used such that all timers MIN value

## PM Control by APM

Options	Descriptions
1. No	System BIOS will ignore APM when power managing the system

2. Yes	System BIOS will wait for APM's prompt before it enter any PM mode e.g. DOZE, STANDBY or SUSPEND
--------	--

### Video Off Method

1. Blank Screen	The system BIOS will only blanks off the screen when disabling video
2. V/H SYNC+Blank	In addition to (1), BIOS will also turn off the V-SYNC & H-SYNC signals form VGA cards to monitor
3. DPMS	This function is enabled for only the VGA card supporting DPM

### Modem Use IRQ

The System can be waked up thru. Modem's activity according to the IRQ setting.

### Doze, Standby, Suspend Mode

Defines the continuous idle time before the system entering DOZE mode. The range is from 1 min to 1 Hr. If any item defined is enabled & active, STANDBY timer will be reloaded

Defines the continuous HDD idle time before the HDD entering power saving mode (motor off). The range is from 1 to 15 Mins. When it is suspended, BIOS will turn the HDD's motor off when system is in SUSPEND mode.

Note: When HDD is in power saving mode, any access to the HDD will wake the HDD up.

### Wake Up Events In Doze & Standby

The specified event's activity causes the PM Timers to be reloaded (i.e. the Power Management Unit (PMU) monitors the specified activities as PM events).

### Power Down & Resume Events

The specified event's activity causes the PM Timers to be reloaded (i.e. the Power Management Unit (PMU) monitors the specified activities as PM events).

SQ594

## PCI Configuration Setup Menu

You can manually configure the PCI Device's IRQ. The following pages tell you the options of each item & describe the meanings of each options.

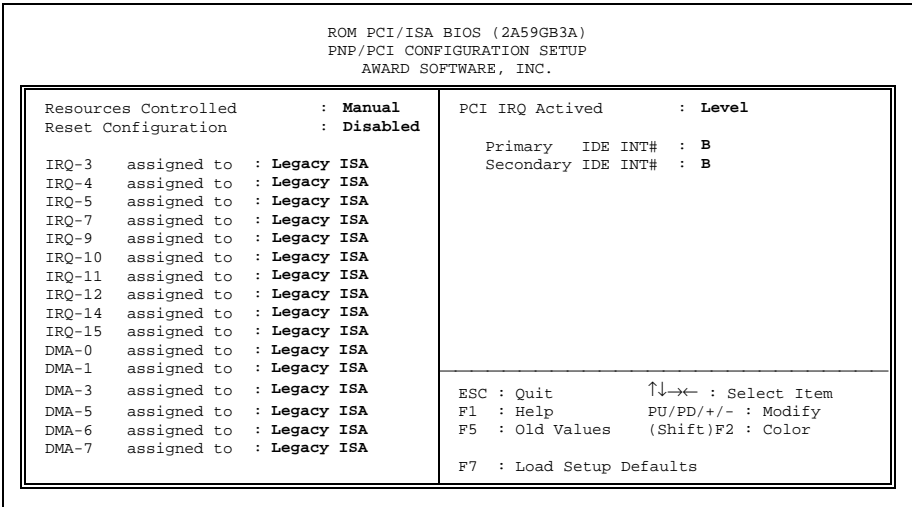

Figure 6

### Resources Controlled

The default setting is Auto, you can change it to Manual for specifying individual IRQ# and DMA# for a 'Legacy' (non Plug Play) ISA card.

### Reset Configuration

This setting is always disabled. The function is used for reset ESCD (Extended System Configuration Data) buffering during the POST phase on system reboot once you have enabled it.

### PCI IRQ Activated by

To tell the Chipset the IRQ signals input is level or edge trigger

### Primary and Secondary IDE INT#

To tell which INT3 does the PCI IDE card is using for its interrupts

## Integrated peripherals Menu

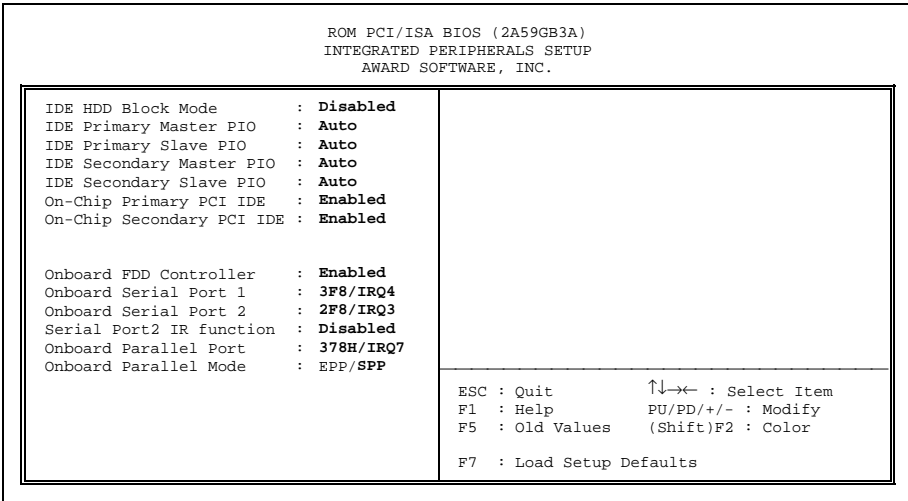

Figure 6

### IDE HDD Block Mode

The default setting is Disabled, Enabled this setting allows your hard disk controller to use the fast block mode to transfer data to and from your hard disk drive (HDD).

Enabled	IDE controller uses block mode.
Disabled	IDE controller uses standard mode.

### IDE PIO

IDE hard drive controllers can support up to two separate hard drives. These drives have a master/slave relationship which are determined by the cabling configuration used to attach them to the controller. Your system supports two IDE controllers--a primary and a secondary--so you have to ability to install up to four separate hard disks.

PIO means Programmed Input Output. Rather than have the BIOS issue a series of commands to effect a transfer to or from the disk drive, PIO allows the BIOS to tell the controller what it wants and then let the controller and the CPU perform the complete task by themselves. This simpler and more efficient (and faster).

Your system supports five modes, numbered from 0 (default) to 4, which primarily differ in timing. When *Auto* is selected, the BIOS will select the best available mode. This is true for the next four setup items:

IDE Primary Master PIO

IDE Primary Slave PIO

IDE Secondary Master PIO

IDE Secondary Slave PIO

## On-Chip Primary PCI IDE

As stated above, your system includes two built-in IDE controllers, both of which operate on the PCI bus. This setup item allows you either to enable or disable the primary controller. You might choose to disable the controller if you were to add a higher performance or specialized controller.

Enabled	Primary HDD controller used (Default)
Disabled	Primary HDD controller not used.

## On-Chip Secondary PCI IDE

As above for the Primary controller, this setup item you either to enable or disable the secondary controller. You might choose to disable the controller if you were to add a higher performance or specialized controller.

Enabled	Secondary HDD controller used (Default)
Disabled	Secondary HDD controller not used.

## Onboard FDC Controller

This should be enabled if your system has a floppy disk controller (FDC) installed on the system board and you wish to use it. Even when so equipped, if you add a higher performance controller, you will need to disable this feature.

Enabled	Onboard floppy disk controller active (Default)
Disabled	Either onboard floppy disk controller absent of not to be used.

## Onboard Serial Port 1

This allows you to determine how the serial port number one installed on your mainboard is to be configured.

COM1, 3F8	IRQ 4(Default)
COM2, 2F8	IRQ 3
COM3, 3E8	IRQ 4
COM4, 2E8	IRQ 3

Disabled	Serial port 1 disabled
----------	------------------------

## Onboard Serial Port 2

This allows you to determine how the serial port number two installed on your mainboard is to be configured.

COM1, 3F8	IRQ 4
COM2, 2F8	IRQ 3(Default)
COM3, 2E8	IRQ 3
COM4, 3E8	IRQ 4
Disabled	Serial port 2 disabled

## Serial Port 2 IR function

Makes serial port 2 available to infrared applications. Access onboard serial port 2 controller with which I/O address. The default setting is 'Disable'.

## Onboard Parallel Port

This can be used to change the default port address of the onboard parallel (printer) port.

378/IRQ7	Standard LPT1 address (Default)
278/IRQ5	Standard LPT2 address
3BC/IRQ7	Alternate LPT address
Disabled	Printer parallel port disabled

## Onboard Parallel Mode

This allows you to select the operation mode of the onboard printer port.

SPP	Standard parallel port mode
EPP	Bi-directional mode
ECP	Fast, buffered
EPP/ECP	Bi-directional and buffered
EPP/SPP	Bi-directional and Standard (Default)



## Password Setting

When you select this function, the following message will appear at the center of the screen to assist you in creating a password

### **ENTER PASSWORD:**

Type the password, up to eight characters, and press <Enter>. The password typed now will clear any previously entered password from CMOS memory. You will be asked to confirm the password. Type the password again and press <Enter>. You may also press <Esc> to abort the selection and not enter a password.

To disable password, just press <Enter> when you are prompted to enter password. A message will confirm the password being disabled. Once the password is disabled, the system will boot and you can enter Setup freely.

### **PASSWORD DISABLED.**

If you select System at Security Option of BIOS Features Setup Menu, you will be prompted for the password every time the system is rebooted or any time you try to enter Setup. If you select Setup at Security Option of BIOS Features Setup Menu, you will be prompted only when you try to enter Setup.

## IDE HDD Auto Detection

BIOS setup will display all possible modes that supported by the HDD including NORMAL, LBA & LARGE.

if HDD does not support LBA mode, no 'LBA' option will be shown.

if no of cylinders is less than or equal to 1024, no 'LARGE' option will be show

Users can select a mode which is appropriate for them.



