

5AMMC

USER'S MANUAL

- * Support Intel Pentium, MMX, Cyrix/IBM 6x86MX, MII, AMD K5, K6, K6-2 & IDT C6 CPUs.

- * Support auto detect CPU Voltage.

- * Support Parity check or Ecc Function.

- * Support Fully AGP 1.0 Specification.

- * Support switching mode Voltage regulator on Board.

- * Support 66/75/83/95 MHz and 100MHz.

- * System power on by Keyboard: If your ATX power supply

supports

100 - 300 mA 5V Stand-By current (rest with keyboard require),

you

can power on your system by entering password from the Keyboard after setting the "Keyboard power on" jumper (JP4)

and

password in CMOS Setup.

- * Support Modem Ring On (COM A, COM B).

- * Support Wake on Lan(The ATX power supply supports larger than 720 mA 5V Stand-By current).

- * ESS SOLO-1 ES1938S PCI Sound On Board.

- * ATi RAGE IIC AGP Display Card On Board (4MB SGRAM) .

R-11-03-081202

**Pentium[®] Processor PCI - ISA BUS MAINBOARD
REV. 1.1 Third Edition**

The author assumes no responsibility for any errors or omissions which may appear in this document nor does it make a commitment to update the information contained herein.

* THIRD-PARTY BRANDS AND NAMES ARE THE PROPERTY OF THEIR RESPECTIVE OWNERS.

Dec 02, 1998 Taipei, Taiwan

I. CPU Jumper Setting Table:

◆ SW: CPU INT./ EXT. FREQ. RATIO

O	ON
X	OFF

SW	2	3	8
x 1.5	X	X	X
x 2	O	X	X
x 2.5	O	O	X
x 3	X	O	X
x 3.5	X	X	X
x 4	O	X	O
x 4.5	O	O	O
x 5	X	O	O
x 5.5	X	X	O

SW	4	5	6	7
AUTO	X	X	X	O
2.0 V	X	X	X	X
2.1 V	X	X	O	X
2.2 V	X	O	X	X
2.3 V	X	O	O	X
2.4 V	O	X	X	X
2.5 V	O	X	O	X
2.6 V	O	O	X	X
2.7 V	O	O	O	X
2.8 V	X	X	X	O
2.9 V	X	X	O	O
3.0 V	X	O	X	O
3.1 V	X	O	O	O
3.2 V	O	X	X	O
3.3 V	O	X	O	O
3.4 V	O	O	X	O
3.5 V	O	O	O	O

MHz	SW1	JP8	JP9
66	X	2-3	2-3
75	O	1-2	2-3
83	X	1-2	2-3
95	O	1-2	1-2
100	X	1-2	1-2

II. Quick Installation Guide:

CPU	SW1	SW2	SW3	SW4	SW5	SW6	SW7	SW8	JP8	JP9
1. Pentium [®] Processor 133 MHz	OFF	ON	OFF	OFF	OFF	OFF	ON	OFF	2-3	2-3
2. Pentium [®] Processor 166 MHz	OFF	ON	ON	OFF	OFF	OFF	ON	OFF	2-3	2-3
3. Pentium [®] Processor 200 MHz	OFF	OFF	ON	OFF	OFF	OFF	ON	OFF	2-3	2-3
4. Intel MMX-166MHz	OFF	ON	ON	OFF	OFF	OFF	ON	OFF	2-3	2-3
5. Intel MMX-200MHz	OFF	OFF	ON	OFF	OFF	OFF	ON	OFF	2-3	2-3
6. Intel MMX-233MHz	OFF	OFF	OFF	OFF	OFF	OFF	ON	OFF	2-3	2-3
7. AMD-K6/166 (2.9V)	OFF	ON	ON	OFF	OFF	ON	ON	OFF	2-3	2-3
8. AMD-K6/200 (2.9V)	OFF	OFF	ON	OFF	OFF	ON	ON	OFF	2-3	2-3
9. AMD-K6/233 (3.2V)	OFF	OFF	OFF	ON	OFF	OFF	ON	OFF	2-3	2-3
10. AMD-K6/266 (66*4 2.2V) AMD-K6-2/266 (66*4 2.2V)	OFF	ON	OFF	OFF	ON	OFF	OFF	ON	2-3	2-3
11. AMD-K6/300 (66*4.5 2.2V)	OFF	ON	ON	OFF	ON	OFF	OFF	ON	2-3	2-3
12. AMD-K6/300 (100*3 2.2V) AMD-K6-2/300 (100*3 2.2V)	OFF	OFF	ON	OFF	ON	OFF	OFF	OFF	1-2	1-2
13. AMD-K6-2/333 (95*3.5 2.2V)	ON	OFF	OFF	OFF	ON	OFF	OFF	OFF	1-2	1-2
14. AMD-K6-2/350(100*3.5 2.2V)	OFF	OFF	OFF	OFF	ON	OFF	OFF	OFF	1-2	1-2
15. AMD-K6-2/380 (95*4 2.2V)	ON	ON	OFF	OFF	ON	OFF	OFF	ON	1-2	1-2

16. AMD-K6-2/400 (100*4 2.2V)	OFF	ON	OFF	OFF	ON	OFF	OFF	ON	1-2	1-2
17. Cyrix/IBM 6x86MX-PR166 (66*2 2.9V)	OFF	ON	OFF	OFF	OFF	ON	ON	OFF	2-3	2-3
18. Cyrix/IBM 6x86MX-PR200 (66*2.5 2.9V)	OFF	ON	ON	OFF	OFF	ON	ON	OFF	2-3	2-3
19. Cyrix/IBM 6x86MX-PR200 (75*2 2.9V)	ON	ON	OFF	OFF	OFF	ON	ON	OFF	1-2	2-3
20. Cyrix/IBM 6x86MX-PR233 (66*3 2.9V)	OFF	OFF	ON	OFF	OFF	ON	ON	OFF	2-3	2-3
CPU	SW1	SW2	SW3	SW4	SW5	SW6	SW7	SW8	JP8	JP9
21. Cyrix/IBM 6x86MX-PR233 (75*2.5 2.9V)	ON	ON	ON	OFF	OFF	ON	ON	OFF	1-2	2-3
22. Cyrix/IBM 6x86MX-PR233 (83*2 2.9V)	OFF	ON	OFF	OFF	OFF	ON	ON	OFF	1-2	2-3
23. Cyrix/IBM 6x86MX-PR266 (66*3.5 2.9V)	OFF	OFF	OFF	OFF	OFF	ON	ON	OFF	2-3	2-3
24. Cyrix/IBM 6x86MX-PR266 (75*3 2.9V)	ON	OFF	ON	OFF	OFF	ON	ON	OFF	1-2	2-3
25. Cyrix/IBM 6x86MX-PR266 (83*2.5 2.9V)	OFF	ON	ON	OFF	OFF	ON	ON	OFF	1-2	2-3
26. Cyrix MII-PR333 (83*3 2.9V)	OFF	OFF	ON	OFF	OFF	ON	ON	OFF	1-2	2-3
27. Cyrix MII-PR333 (75*3.5 2.9V)	ON	OFF	OFF	OFF	OFF	ON	ON	OFF	1-2	2-3
28. Cyrix MII-PR300 (66*3.5 2.9V)	OFF	OFF	OFF	OFF	OFF	ON	ON	OFF	2-3	2-3
29. IDT C6-200 (66*3 3.52V)	OFF	OFF	ON	OFF	OFF	OFF	ON	OFF	2-3	2-3
30. IDT C6-225 (75*3 3.52V)	ON	OFF	ON	OFF	OFF	OFF	ON	OFF	1-2	2-3
31. IDT C6-266 (66*4 3.52V)	OFF	ON	OFF	OFF	OFF	OFF	ON	ON	2-3	2-3

★ Note: If Cyrix 6x86 is being used, please check the CPU Date Code after 605.

● **The default setting is 100*3 at 2.2V for AMD K6/300 and AMD K6-2/300**

CPU	SW1	SW2	SW3	SW4	SW5	SW6	SW7	SW8	JP8	JP9
AMD-K6/300 (100*3 2.2V) AMD-K6-2/300 (100*3 2.2V)	OFF	OFF	ON	OFF	ON	OFF	OFF	OFF	1-2	1-2

1. Pentium[®] Processor 133 MHz

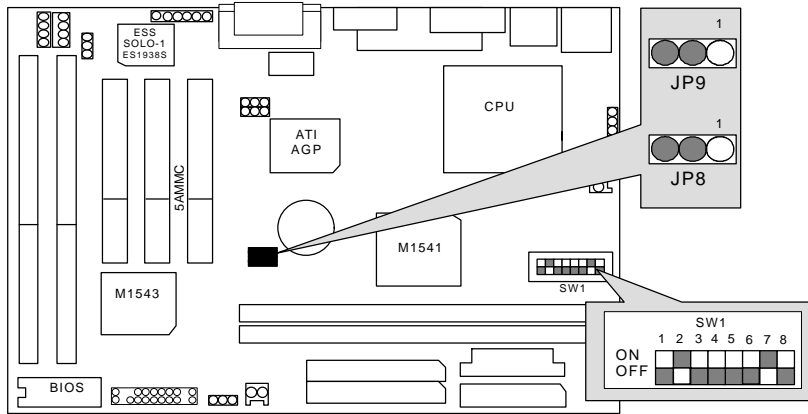

2. Pentium[®] Processor 166 MHz

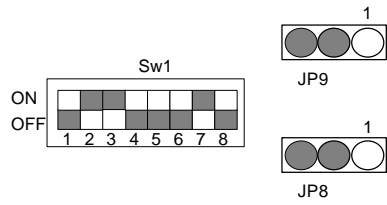

3. Pentium[®] Processor 200 MHz

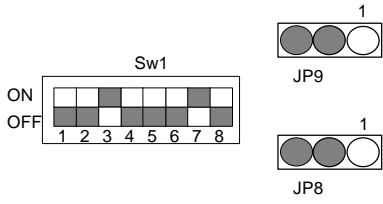

4. Intel MMX-166 MHz

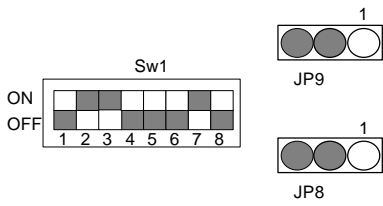

5. Intel MMX-200 MHz

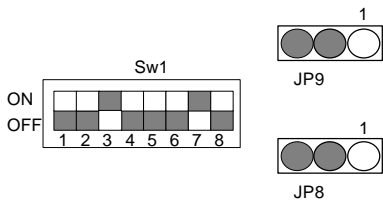

6. Intel MMX-233 MHz

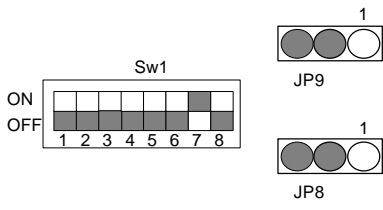

7. AMD-K6/166 (2.9V)

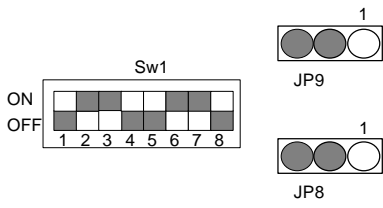

8. AMD-K6/200 (2.9V)

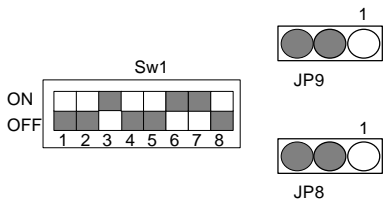

9. AMD-K6/233 (3.2V)

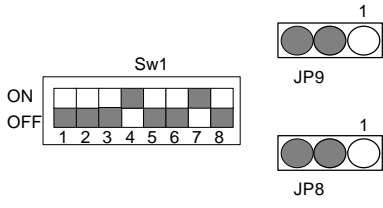

10. AMD-K6/266 (2.2V 66*4); AMD-K6-2/266 (2.2V 66*4)

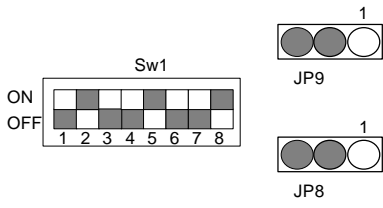

11. AMD-K6/300 (2.2V 66*4.5)

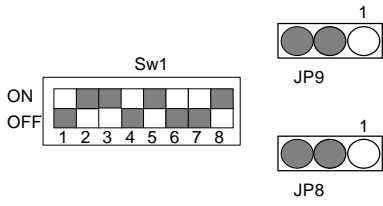

12. AMD-K6/300 (2.2V 100*3); AMD-K6-2/300 (2.2V 100*3)

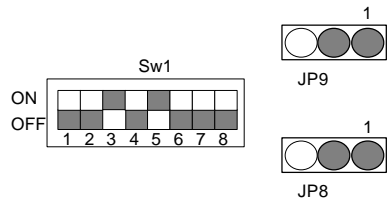

13. AMD-K6-2/333 (2.2V 95*3.5)

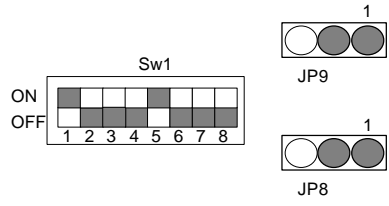

14. AMD-K6-2/350 (2.2V 100*3.5)

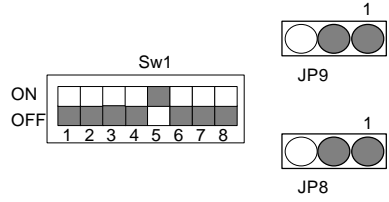

15. AMD-K6-2/380 (95*4 2.2V)

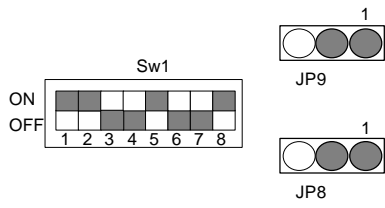

16. AMD-K6-2/400 (100*4 2.2V)

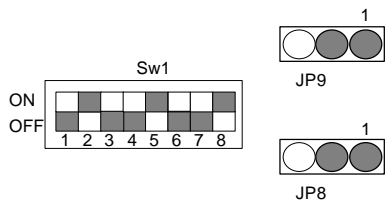

17. Cyrix / IBM 6x86MX-PR166 (66*2 2.9V)

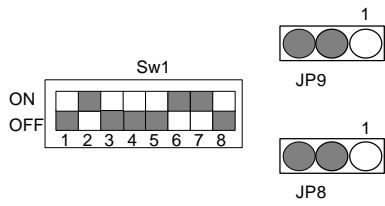

18. Cyrix / IBM 6x86MX-PR200 (66*2.5 2.9V)

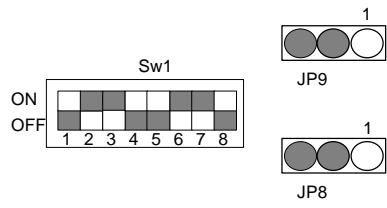

19. Cyrix / IBM 6x86MX-PR200 (75*2 2.9V)

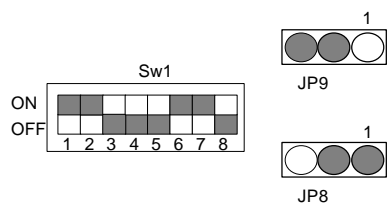

20. Cyrix / IBM 6x86MX-PR233 (66*3 2.9V)

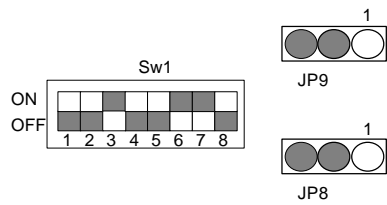

21. Cyrix / IBM 6x86MX-PR233 (75*2.5 2.9V)

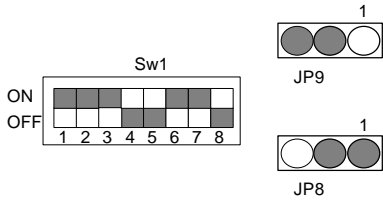

22. Cyrix / IBM 6x86MX-PR233 (83*2 2.9V)

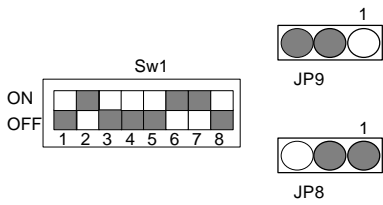

23. Cyrix / IBM 6x86MX-PR266 (66*3.5 2.9V)

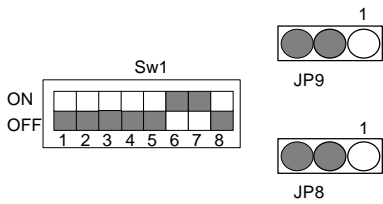

24. Cyrix / IBM 6x86MX-PR266 (75*3 2.9V)

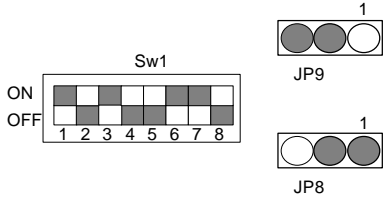

25. Cyrix / IBM 6x86MX-PR266 (83*2.5 2.9V)

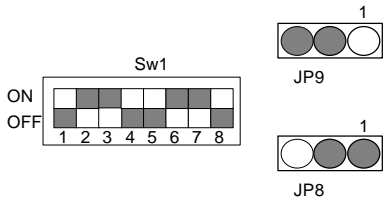

26. Cyrix MII-PR333 (83*3 2.9V)

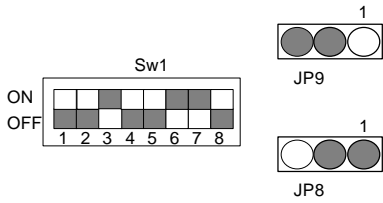

27. Cyrix MII-PR333 (75*3.5 2.9V)

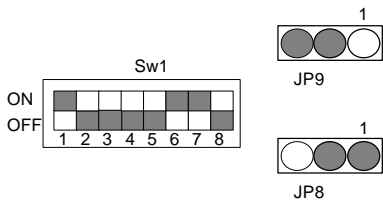

28. Cyrix MII-PR300 (66*3.5 2.9V)

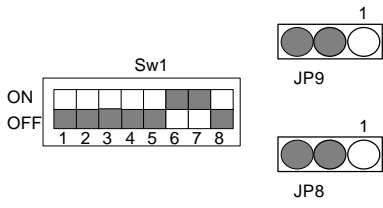

29. IDT C6-200 (66*3 3.52V)

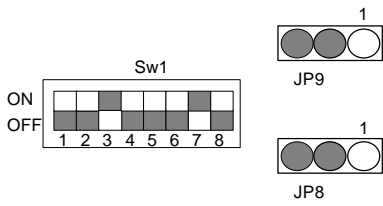

30. IDT C6-225 (75*3 3.52V)

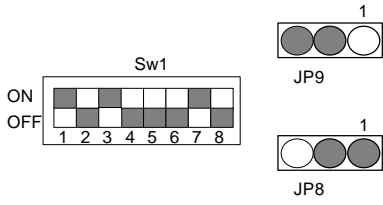

31. IDT C6-266 (66*4 3.52V)

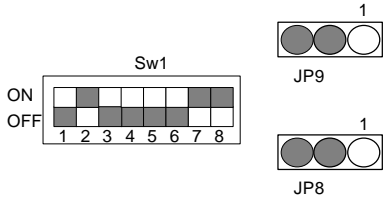

III. Quick Installation Guide of Jumper setting:

SPK : Speaker Connector

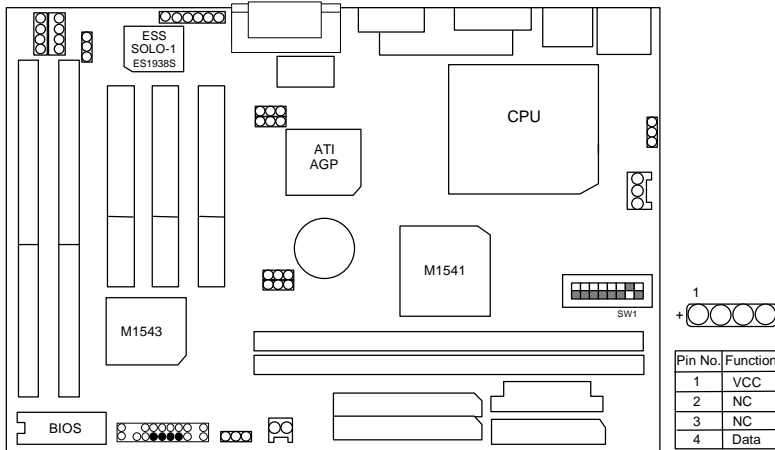

RST : Reset Switch

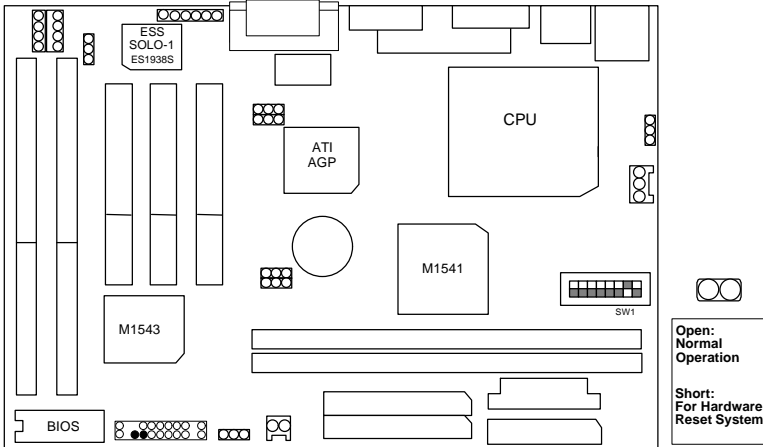

PWR LED : Power LED

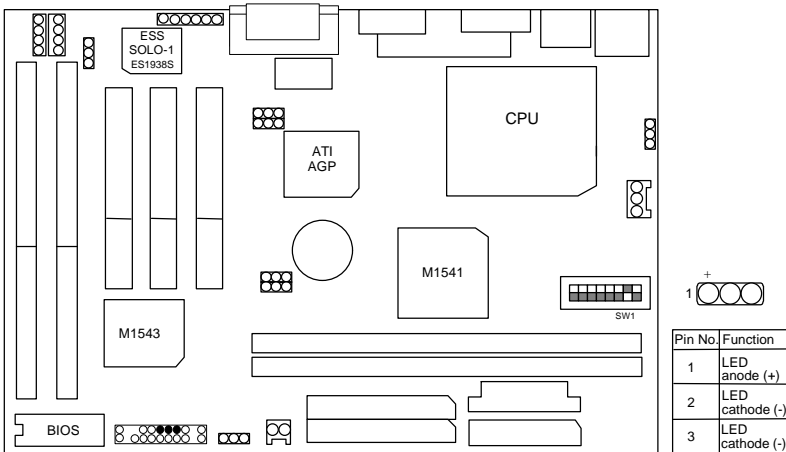

HD : IDE Hard Disk Active LED

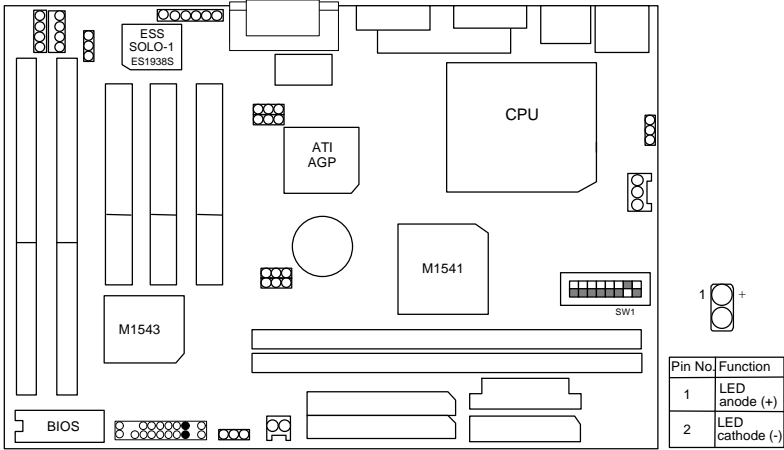

GN : Green Function Switch

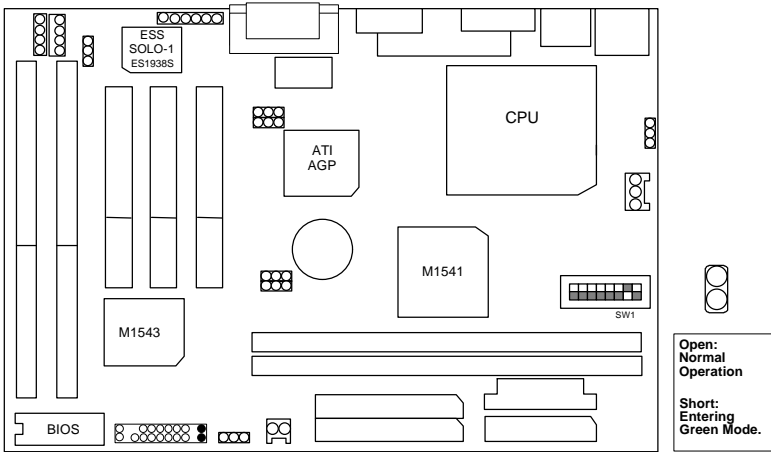

GD : Green LED

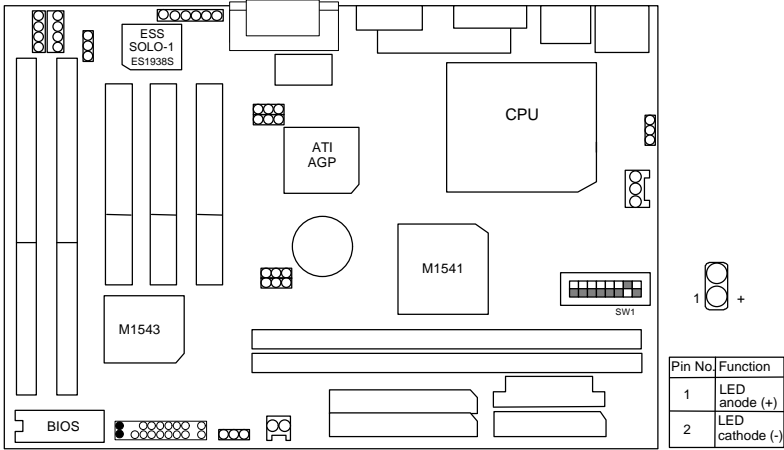

SOFT PWR : Power On/Off Switch

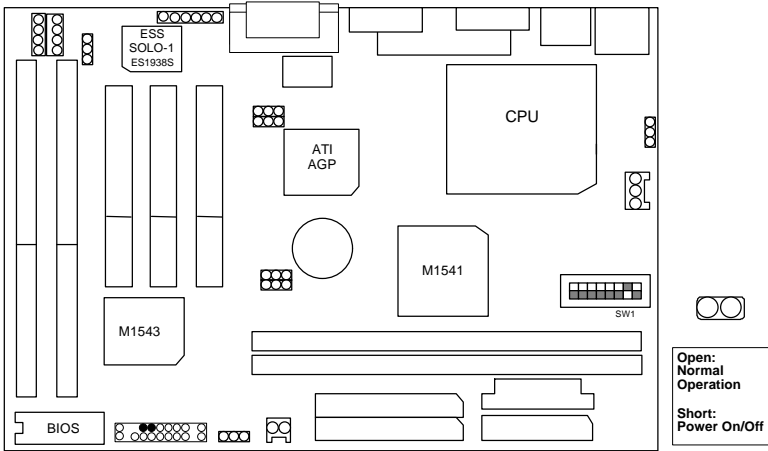

ATX Power Connector

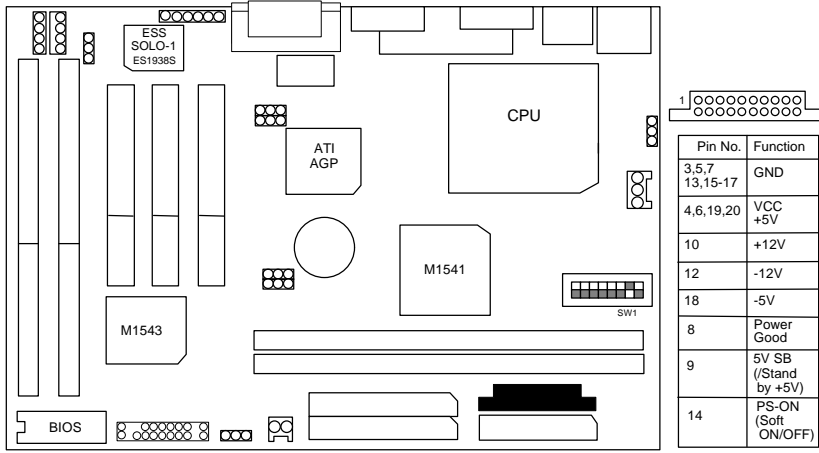

JP7 : CPU Cooling Fan Power Connector

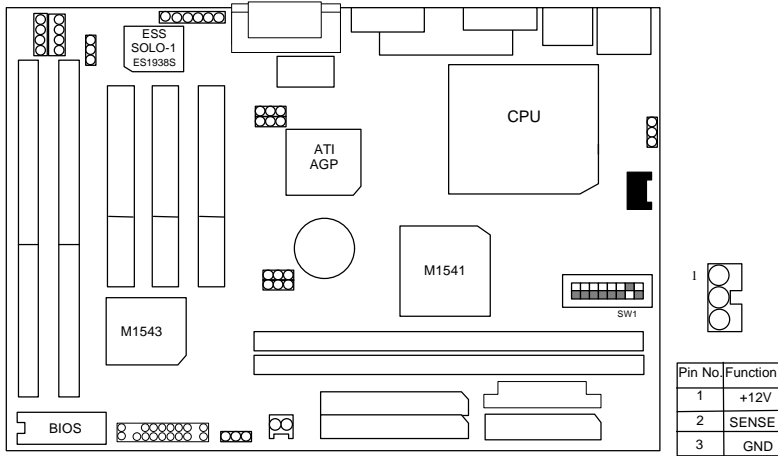

J2: Wake On Lan

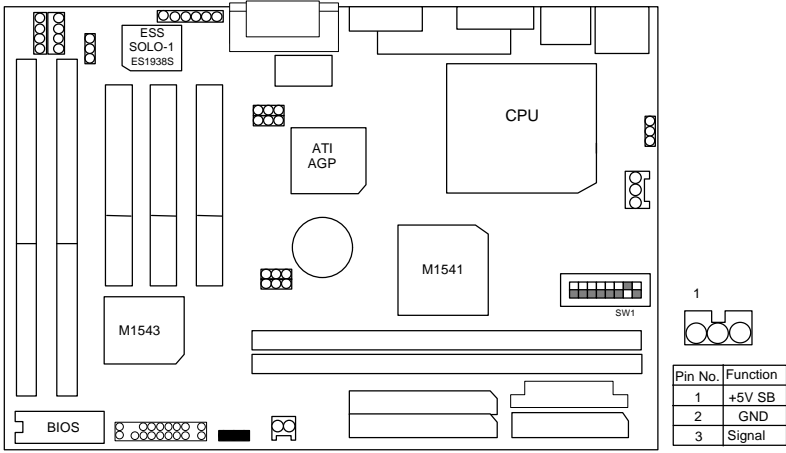

LPT / COM A / VGA PORT

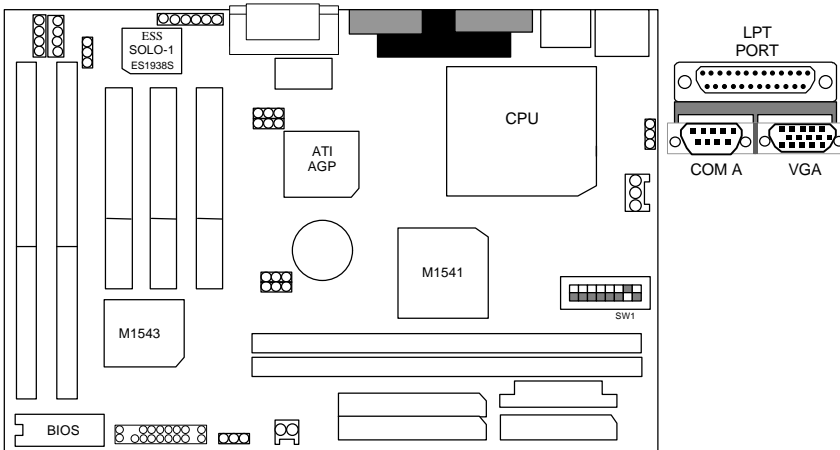

USB : USB Port

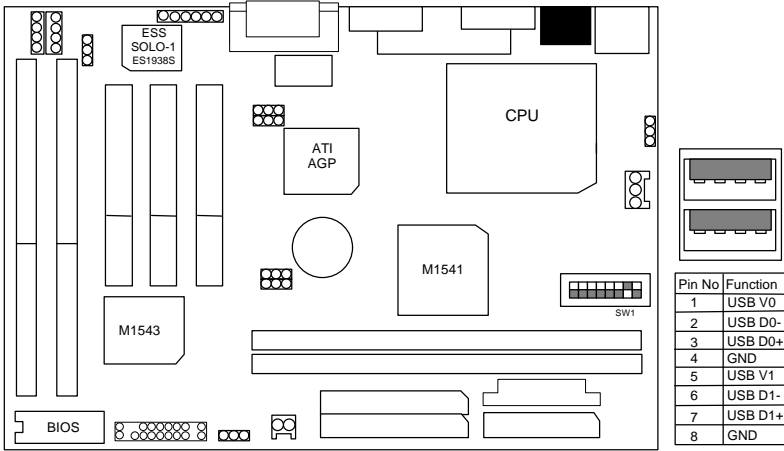

COM B : COM B PORT

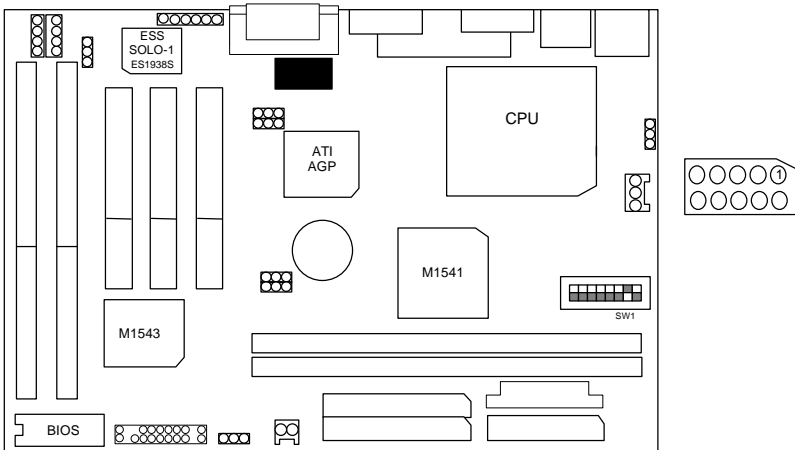

PS/2 : PS/2 Mouse / Keyboard Connector

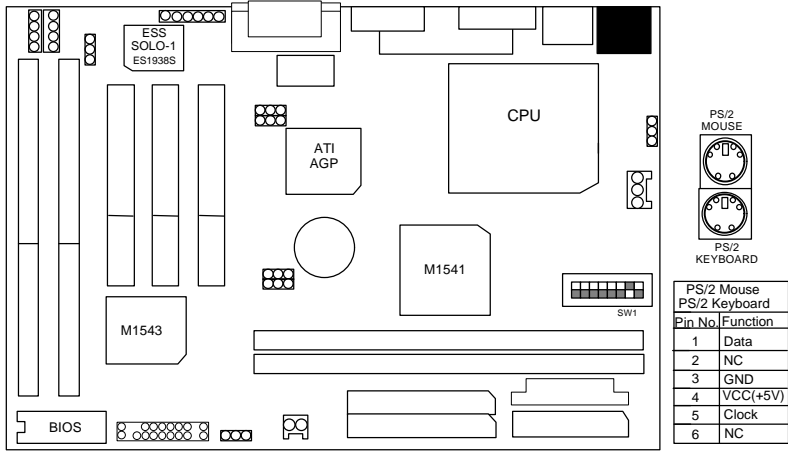

FLOPPY : FLOPPY PORT

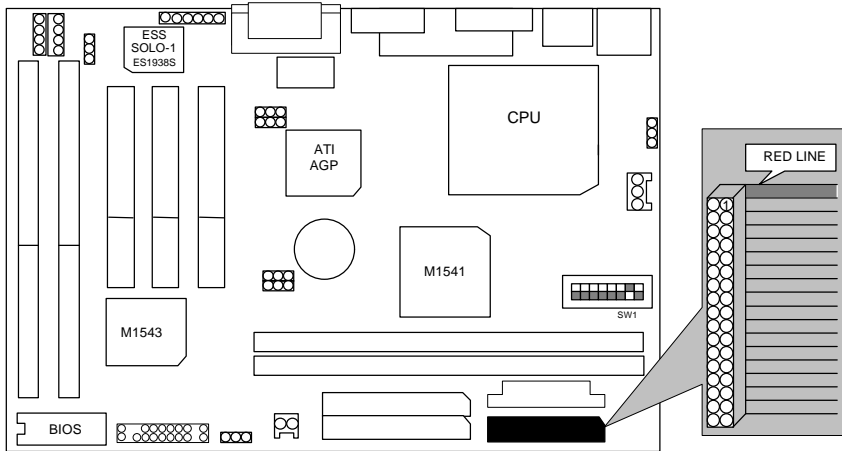

IDE 1 : For Primary IDE port

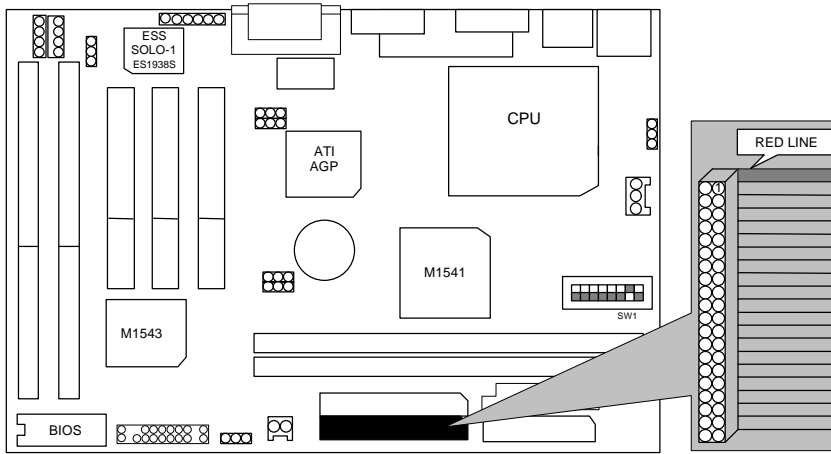

IDE 2 : For Secon dary IDE port

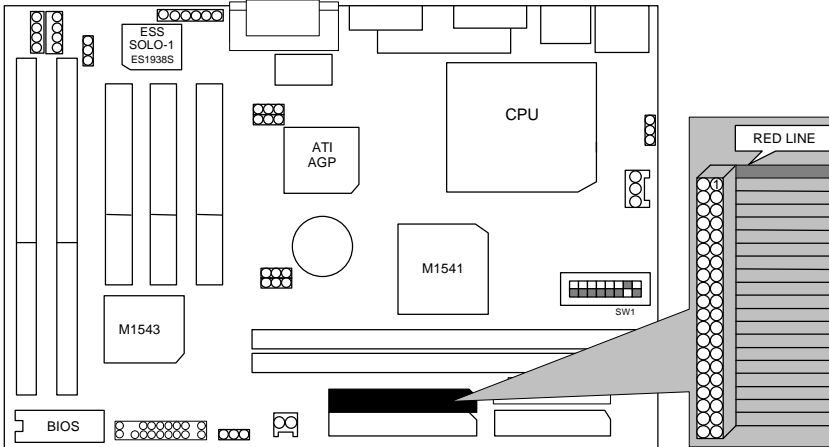

GAME & AUDIO PORT (External)

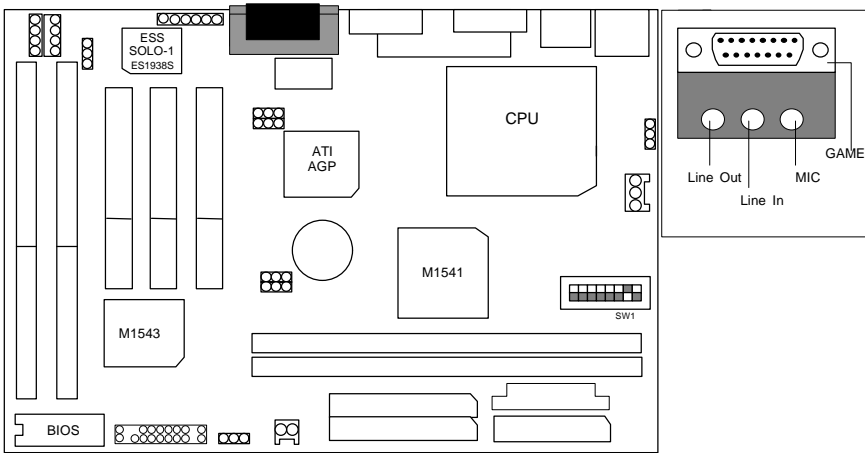

J3 : GAME & AUDIO Connector (Internal) (Optional)

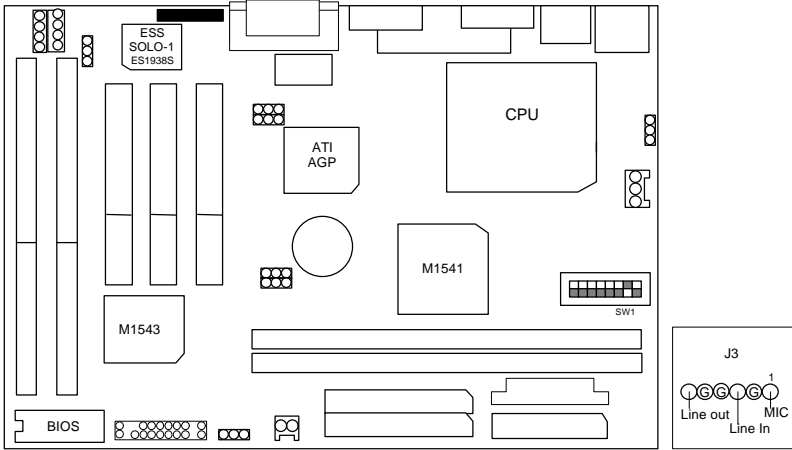

JP4 : Keyboard Power On Select

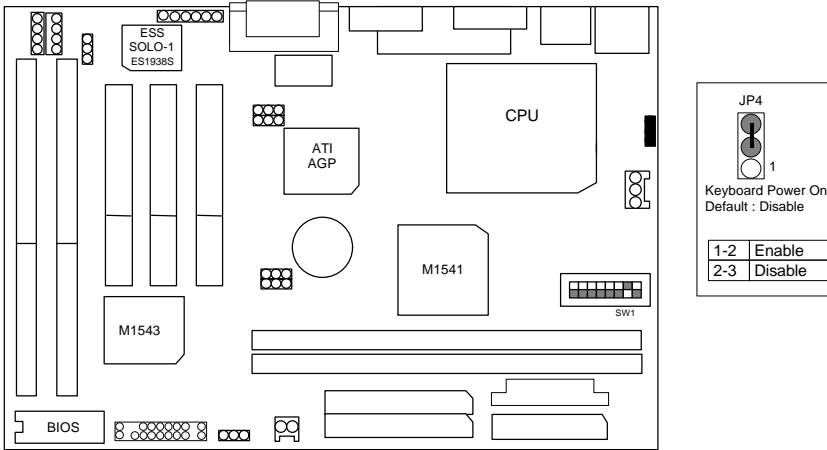

JP5 : Onboard AGP Function

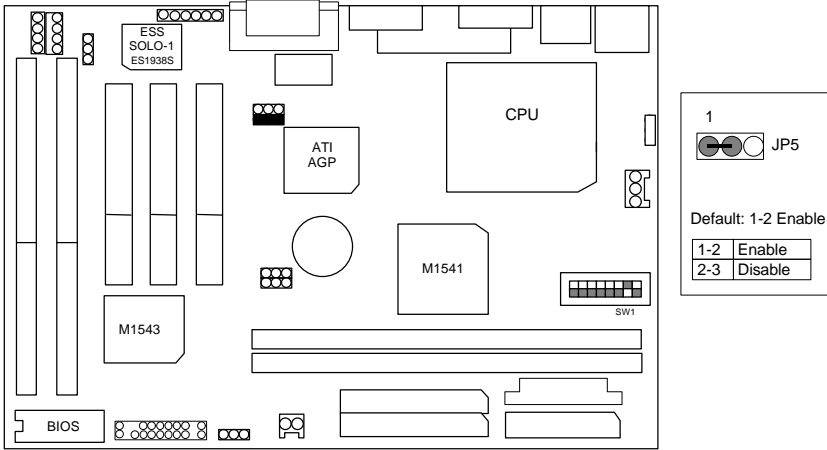

JP6 : Release Onboard VGA from occupying IRQ Resource
(It is not to enable or disable Onboard VGA Function.)

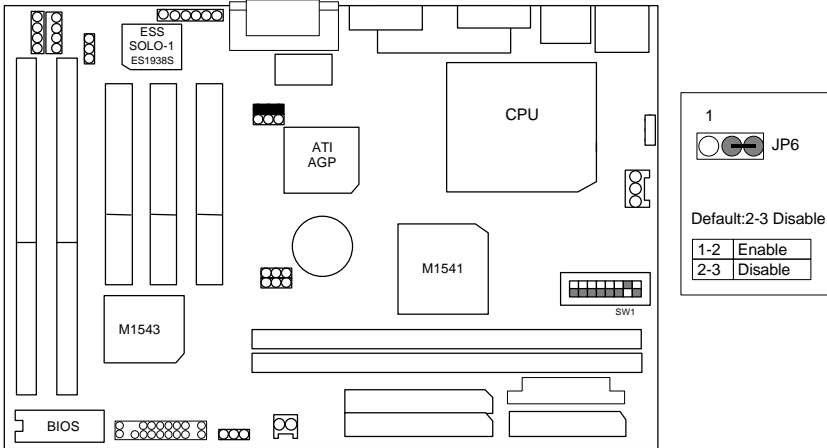

JP3 : Onboard Audio Function

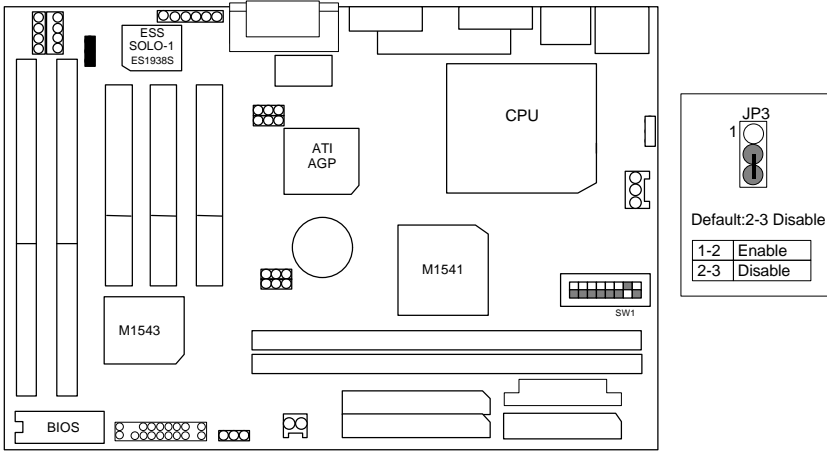

J9/J4 : CD Audio Line-in Connector

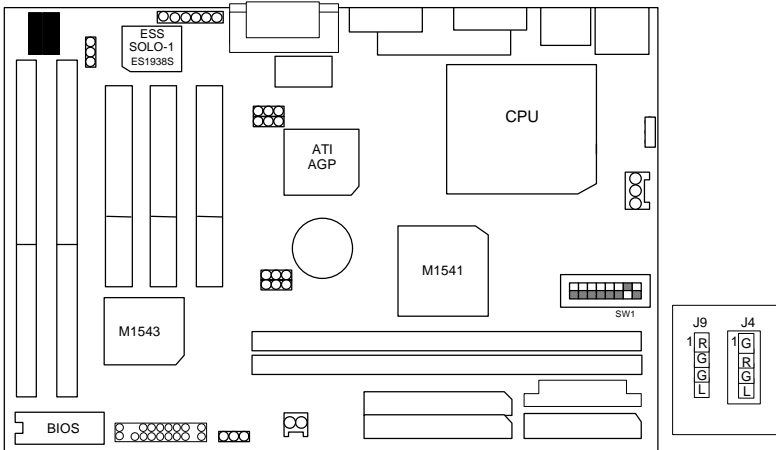

JP12 : Wake On Ring

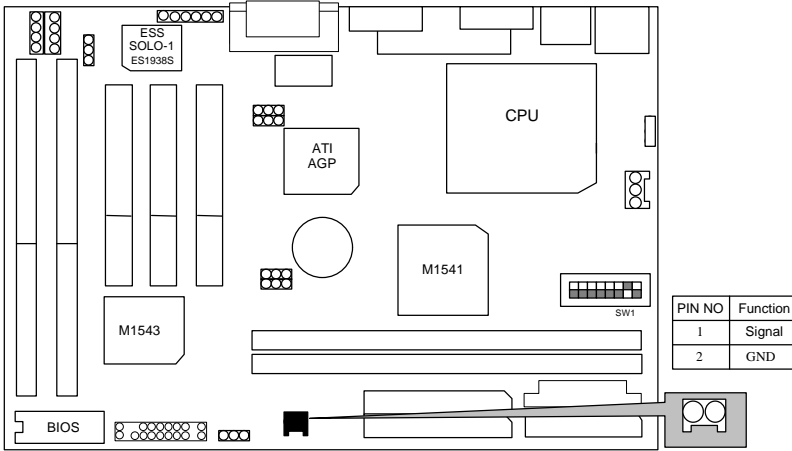

BAT1 : For Battery

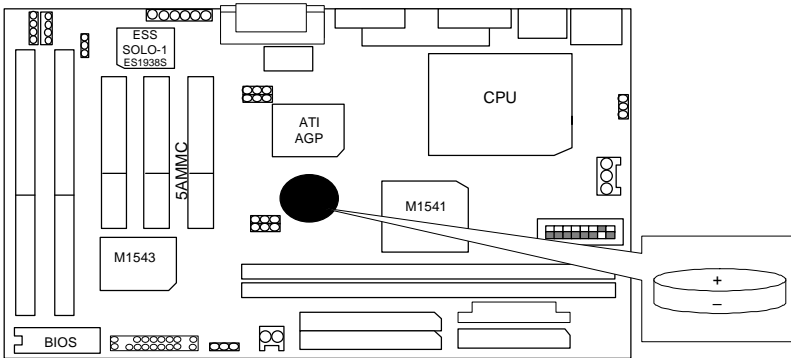

Danger of explosion if battery is incorrectly replaced.
 Replace only with the same or equivalent type recommended by the manufacturer.
 Dispose of used batteries according to the manufacturer's instructions

III. Top Performance Test Setting:

Users have to modify the value for each item in chipset features as follow

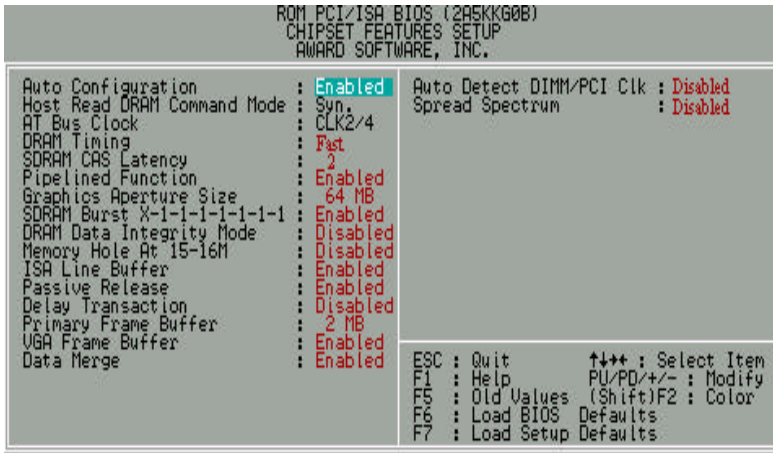

for top performance setting.

- ** Each value of items as above depends on your hardware configuration : CPU , SDRAM , Cards , etc.
Please modify each value of items If your system does not work properly.

PERFORMANCE LIST

The following list of performance data is the testing results of some popular benchmark testing programs.

These data are just referred by users, and there is no responsibility for different testing data values gotten by users. (The different Hardware & Software configuration will result in different benchmark testing results.)

- CPU Pentium® Processor MMX-233 MHz, Cyrix 6x86MX-PR233, AMD K6-2 300
- DRAM (64 × 2) MB SDRAM (LGS GM72V66841CT7J)
- CACHE SIZE 512 KB
- DISPLAY Onboard ATi RAGE IIC AGP Card (4MB SGRAM)
- STORAGE Onboard IDE (Seagate ST34520A)
- O.S. Windows® NT 4.0
- DRIVER Display Driver at 1024 x 768 x 256 colors x 75Hz.
ALi Bus Master IDE Driver

Processor	Intel-MMX 233MHz (66x3.5)	AMD K6-2 300 (100x3)	Cyrix 6x86MX- PR233 (75x2.5)
Winbench98 CPU mark32	468	769	468
FPU Winmark	916	984	424
Business Disk	1890	2020	1850
Hi-End Disk	4110	4710	3980
Business Graphics	102	145	103
Hi-End Graphics	112	162	120
Winstone98 Business	21.9	29	21.7
Hi-End	23.4	29.9	22.3