



- ✍ The author assumes no responsibility for any errors or omissions that may appear in this document nor does the author make a commitment to update the information contained herein.**
  
- ✍ Third-party brands and names are the property of their respective owners.**
  
- ✍ Please do not remove any labels on motherboard, this may void the warranty of this motherboard.**
  
- ✍ Due to rapid change in technology, some of the specifications might be out of date before publication of this booklet.**



**WARNING:** Never run the processor without the heatsink properly and firmly attached. **PERMANENT DAMAGE WILL RESULT!**

**Mise en garde:** Ne faites jamais tourner le processeur sans qu'il soit correctement et fermement fixé. **UN DOMMAGE PERMANENT EN RÉSULTERA.**

**Anleitung:** Der Prozessor darf nur in Betrieb genommen werden, wenn die Wärmehalbleiter ordnungsgemäß und fest angebracht ist. **DIES HAT EINEN PERMANENTEN SCHADEN ZUR FOLGE!**

**Advertencia:** Nunca haga funcionar el procesador sin el dissipador de calor instalado correcta y firmemente. **SE PRODUCIRÁ UN DAÑO PERMANENTE!**

**Aviso:** Nunca execute o processador sem o dissipador de calor estáo corretamente e firmemente conectado. **O RESULTADO SERÁ UM DANO PERMANENTE!**

**警告:** 請務必將中置換熱管安裝妥當且固定牢靠，否則將造成永久損傷！

**警告:** 請務必將中置換熱管安裝妥當且固定牢靠，否則將造成永久損傷！

**경고:** 프로세서를 올바르게 설치하지 않거나 고정하지 않으면 프로세서가 영구적으로 손상될 수 있습니다.

**警告:** 處理器安裝不當或固定不牢，可能會造成永久損傷。請務必將中置換熱管安裝妥當且固定牢靠，否則將造成永久損傷！

## **DECLARATION OF CONFORMITY**

Per FCC Part 2 Section 2.1077(a)



**Responsible Party Name: G.B.T. INC. (U.S.A.)**

**Address: 17358 Railroad Street**

**City of Industry, CA 91748**

**Phone/Fax No: (818) 854-9338 / (818) 854-9339**

hereby declares that the product

**Product Name: Motherboard**

**Model Number: GA-7VKML**

Conforms to the following specifications:

FCC Part 15, Subpart B, Section 15.107(a) and Section 15.109(a),  
Class B Digital Device

### **Supplementary Information:**

This device complies with part 15 of the FCC Rules. Operation is subject to the following two conditions: (1) This device may not cause harmful and (2) this device must accept any interference received, including that may cause undesired operation.

Representative Person's Name: ERIC LU

Signature: Eric Lu

Date: January 9, 2002

## Declaration of Conformity

We, Manufacturer/Importer  
(full address)

**G.B.T. Technology Trading GmbH**  
Ausschlagweg 41, 1F, 20537 Hamburg, Germany

declare that the product  
(description of the apparatus, system, installation to which it refers)

### **Mother Board**

GA-7 VKML

is in conformity with

(reference to the specification under which conformity is declared)

in accordance with 89/336 EEC-EMC Directive

EN 55011	Limits and methods of measurement of radio disturbance characteristics of industrial, scientific and medical (ISM) high frequency equipment	EN 61000-3-2* EN 61555-2	Disturbances in supply systems cause by household appliances and similar electrical equipment " Harmonics"
EN 55013	Limits and methods of measurement of radio disturbance characteristics of broadcast receivers and associated equipment	EN 61000-3-3* EN 61555-3	Disturbances in supply systems cause by household appliances and similar electrical equipment " Voltage fluctuations"
EN 55014	Limits and methods of measurement of radio disturbance characteristics of household electrical appliances, portable tools and similar electrical apparatus	EN 5081-1 EN 5082-1	Generic emission standard Part 1: Residual commercial and light industry Generic immunity standard Part 1: Residual commercial and light industry
EN 55015	Limits and methods of measurement of radio disturbance characteristics of fluorescent lamps and luminaries	EN 5081-2	Generic emission standard Part 2: Industrial environment
EN 55020	Immunity from radio interference of broadcast receivers and associated equipment	EN 5082-2	Generic emission standard Part 2: Industrial environment
EN 55022	Limits and methods of measurement of radio disturbance characteristics of information technology equipment	ENV 55104	Immunity requirements for household appliances tools and similar apparatus
DIN VDE 0855 part 10 part 12	Cabled distribution systems: Equipment for receiving and/or distribution from sound and television signals	EN 50091-2	EMC requirements for uninterruptible powersystems (UPS)
CE marking			(EC conformity marking)

The manufacturer also declares the conformity of above mentioned product with the actual required safety standards in accordance with LVD 73/23/EEC

EN 60065	Safety requirements for mains operated electronic and related apparatus for household and similar general use	EN 60950
EN 60335	Safety of household and similar electrical appliances	EN 50091-1

### Manufacturer/Importer

(S la mp)

Date: January 9, 2002

Signature: Timmy Huang  
Name: Timmy Huang

GA-7VKML  
AMD Socket A Processor Motherboard

# USER'S MANUAL

AMD Socket A Processor Motherboard  
Rev. 1.1 First Edition  
12ME-7VKML-1101

## Table of Content

Revision History .....	4
Item Checklist .....	4
WARNING! .....	5
Chapter 1 Introduction .....	6
Features Summary .....	6
GA-7VKML Motherboard Layout .....	8
Chapter 2 Hardware Installation Process .....	9
Step 1: Install the Central Processing Unit (CPU) .....	10
Step1-1: CPU Speed Setup .....	10
Step1-2: CPU Installation .....	11
Step1-3: CPU Heat Sink Installation .....	12
Step 2: Install memory modules .....	13
Step 3: Install expansion cards .....	15
Step 4: Connect ribbon cables, cabinet wires, and power supply .....	16
Step4-1: I/O Back Panel Introduction .....	16
Step4-2: Connectors Introduction .....	18
Chapter 3 BIOS Setup .....	24
The Main Menu (For example: BIOS Ver. : F2) .....	25
Standard CMOS Features .....	27
BIOS Features Setup .....	30
Chipset Features Setup .....	32
Power Management Setup .....	36

---

PNP/PCI Configuration .....	39
Load Fail-Safe Defaults .....	41
Load Optimized Defaults .....	42
Integrated Peripherals .....	43
Hardware Monitor & MISC Setup .....	47
Set Supervisor / User Password .....	49
IDE HDD Auto Detection .....	50
Save & Exit Setup .....	51
Exit Without Saving .....	52
Chapter 4 Technical Reference .....	53
Block Diagram .....	53
Q-Flash Utility Introduction .....	54
@ BIOS™ Introduction .....	56
Easy Tunell™ Introduction .....	57
Chapter 5 Appendix .....	58

## Revision History

Revision	Revision Note	Date
1.0	Initial release of the GA-7VKML motherboard user's manual.	Jan. 2002
1.1	Initial release of the GA-7VKML motherboard user's manual.	Jan. 2002

## Item Checklist

- The GA-7VKML motherboard
- IDE cable x 1/ Floppy cable x 1
- CD for motherboard driver & utility
- GA-7VKML user's manual



---

**WARNING!**

Computer motherboards and expansion cards contain very delicate Integrated Circuit (IC) chips. To protect them against damage from static electricity, you should follow some precautions whenever you work on your computer.

1. Unplug your computer when working on the inside.
2. Use a grounded wrist strap before handling computer components. If you do not have one, touch both of your hands to a safely grounded object or to a metal object, such as the power supply case.
3. Hold components by the edges and try not touch the IC chips, leads or connectors, or other components.
4. Place components on a grounded antistatic pad or on the bag that came with the components whenever the components are separated from the system.
5. Ensure that the ATX power supply is switched off before you plug in or remove the ATX power connector on the motherboard.

### **Installing the motherboard to the chassis...**

If the motherboard has mounting holes, but they don't line up with the holes on the base and there are no slots to attach the spacers, do not become alarmed you can still attach the spacers to the mounting holes. Just cut the bottom portion of the spacers (the spacer may be a little hard to cut off, so be careful of your hands). In this way you can still attach the motherboard to the base without worrying about short circuits. Sometimes you may need to use the plastic springs to isolate the screw from the motherboard PCB surface, because the circuit wire may be near by the hole. Be careful, don't let the screw contact any printed circuit write or parts on the PCB that are near the fixing hole, otherwise it may damage the board or cause board malfunctioning.

# Chapter 1 Introduction

## Features Summary

---

Form Factor	<ul style="list-style-type: none"><li>• 24.4cm x 21.7cm Micro ATX size form factor, 4 layers PCB.</li></ul>
CPU	<ul style="list-style-type: none"><li>• Socket A processor AMD Athlon™/Athlon™ XP/Duron™ (K7) Socket A processor 128K L1 &amp; 256K/64K L2 cache on die</li><li>• Supports 1.4GHz and faster</li><li>• 200/266MHz FSB and DDR bus speeds (PCI 33MHz)</li></ul>
Chipset	<ul style="list-style-type: none"><li>• VIA KM266 Memory/AGP/PCI Controller (PAC)</li><li>• VIA VT8233A Integrated Peripheral Controller (PSIPC)</li></ul>
Memory	<ul style="list-style-type: none"><li>• 2 184-pin DDR DIMM sockets</li><li>• Supports PC1600 DDR or PC2100 DDR DIMM</li><li>• Supports up to 1GB DRAM (Max)</li><li>• Supports only 2.5V DDR DIMM</li><li>• Supports 64bit DRAM integrity mode</li></ul>
I/O Control	<ul style="list-style-type: none"><li>• IT8705F</li></ul>
Slots	<ul style="list-style-type: none"><li>• 1 AGP slot (1X/2X/4X) device support</li><li>• 3 PCI Slots Supports 33MHz &amp; PCI 2.2 compliant</li><li>• 1 CNR (Communication and Networking Riser) Slot (only secondary card)</li></ul>
On-Board IDE	<ul style="list-style-type: none"><li>• 2 IDE bus master (ATA66/100/133) IDE ports for up to 4 ATAPI devices</li><li>• Supports PIO mode3,4 (ATA66/100/133) IDE &amp; ATAPI CD-ROM</li></ul>

---

to be continued.....

On-Board Peripherals	<ul style="list-style-type: none"> <li>• 1 Floppy port supports 2 FDD with 360K, 720K, 1.2M, 1.44M and 2.88M bytes.</li> <li>• 1 Parallel port supports Normal/EPP/ECP mode</li> <li>• 2 Serial port (COM A, Internal COM B)</li> <li>• 1 VGA port</li> <li>• 4 USB ports (Rear USB x 2, Front USB x 2)</li> <li>• 1 IrDA connector for IR</li> <li>• 1 Smart Card Reader Header (SCR)*</li> </ul>
Hardware Monitor	<ul style="list-style-type: none"> <li>• CPU/System Fan Revolution detect</li> <li>• CPU/System temperature detect</li> <li>• System Voltage Detect</li> </ul>
On-Board Sound	<ul style="list-style-type: none"> <li>• AC97 CODEC</li> <li>• Line In/Line Out/Mic In/CD_In/Game Port/SPDIF</li> </ul>
On-Board LAN	<ul style="list-style-type: none"> <li>• Build in RTL8100L Chipset</li> </ul>
PS/2 Connector	<ul style="list-style-type: none"> <li>• PS/2 Keyboard interface and PS/2 Mouse interace</li> </ul>
BIOS	<ul style="list-style-type: none"> <li>• Licensed AMI BIOS, 2M bit Flash ROM</li> </ul>
Additional Features	<ul style="list-style-type: none"> <li>• STR(Suspend-To-RAM)</li> <li>• AC Recovery</li> <li>• USB KB/Mouse wake up from S3-S5</li> <li>• PS2 KB/Mouse wake up from S1, S3, S4, S5</li> <li>• Supports @BIOS™</li> <li>• Supports Easy TuneIII™</li> </ul>

- : Please set the CPU host frequency in accordance with your processor's specifications. We don't recommend you to set the system bus frequency over the CPU's specification because these specific bus frequencies are not the standard specifications for CPU, chipset and most of the peripherals. Whether your system can run under these specific bus frequencies properly will depend on your hardware configurations, including CPU, Chipsets, SDRAM, Cards....etc.

\*\*\* Supported on motherboard version: 1.0 only.



## Chapter 2 Hardware Installation Process

To set up your computer, you must complete the following setups:

- Step 1- Set system Jumper(CLK\_SW)
- Step 2- Install the Central Processing Unit (CPU)
- Step 3- Install memory modules
- Step 4- Install expansion cards
- Step 5- Connect ribbon cables, cabinet wires, and power supply
- Step 6- Setup BIOS software
- Step 7- Install supporting software tools

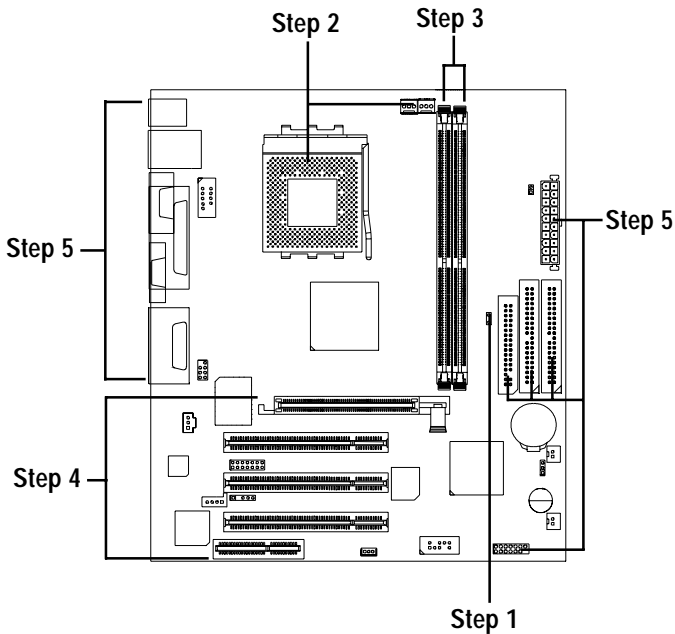

## Step 1: Install the Central Processing Unit (CPU)

### Step1-1: CPU Speed Setup

The system bus frequency can be switched at 100/133MHz by adjusting CLK\_SW.

(The frequency ratio depend on CPU.)

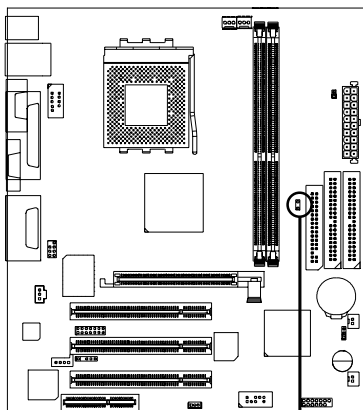

1  
ON  
CLK\_SW

CLK\_SW

OFF: 133MHz
-------------

ON: 100MHz
------------

Default Setting: 100MHz

## Step1-2: CPU Installation

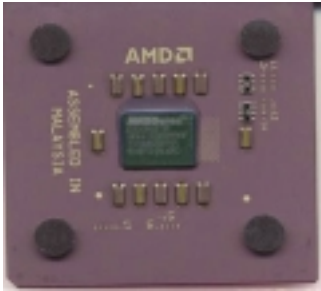

CPU Top View

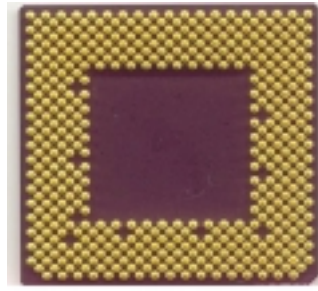

CPU Bottom View

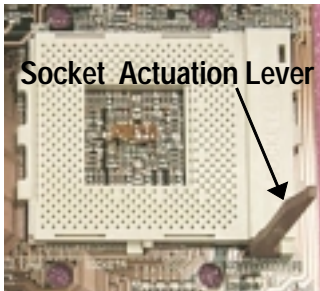

1. Pull up the CPU socket lever and up to 90-degree angle.

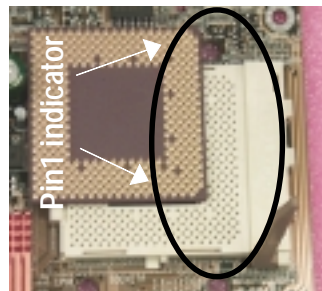

2. Locate Pin 1 in the socket and look for a (golden) cut edge on the CPU upper corner. Then insert the CPU into the socket.

- ⚠ Please make sure the CPU type is supported by the motherboard.
- ⚠ If you do not match the CPU socket Pin 1 and CPU cut edge well, it will cause improper installation. Please change the insert orientation.

### Step1-3: CPU Heat Sink Installation



1. Press down the CPU socket lever and finish CPU installation.



2. Use qualified fan approved by AMD.

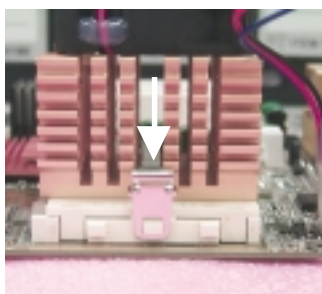

3. Fasten the heatsink supporting-base onto the CPU socket on the main-board.

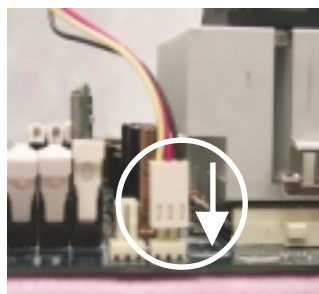

4. Make sure the CPU fan is plugged to the CPU fan connector, than install complete.

- Please use AMD approved cooling fan.
- We recommend you to apply the thermal paste to provide better heat conduction between your CPU and heatsink.
- Make sure the CPU fan power cable is plugged in to the CPU fan connector, this completes the installation.
- Please refer to CPU heat sink user's manual for more detail installation procedure.



## Step 2: Install memory modules

The motherboard has 2 dual inline memory module (DIMM) sockets. The BIOS will automatically detects memory type and size. To install the memory module, just push it vertically into the DIMM Slot.

The DIMM module can only fit in one direction due to the notch. Memory size can vary between sockets.

### Total Memory Sizes With Registered DDR DIMM

Devices used on DIMM	1 DIMMx64/x72	2 DIMMsx64/x72
64 Mbit (4Mx4x4 banks)	256 MBytes	512 MBytes
64 Mbit (2Mx8x4 banks)	128 MBytes	256 MBytes
64 Mbit (1Mx16x4 banks)	64 MBytes	128 MBytes
128 Mbit(8Mx4x4 banks)	512 MBytes	1 GBytes
128 Mbit(4Mx8x4 banks)	256 MBytes	512 MBytes
128 Mbit(2Mx16x4 banks)	128 MBytes	256 MBytes
256 Mbit(8Mx8x4 banks)	512 MBytes	1 GBytes
256 Mbit(4Mx16x4 banks)	256 MBytes	512 MBytes
512 Mbit(8Mx16x4 banks)	512 MBytes	1 GBytes

### Total Memory Sizes With Unbuffered DDR DIMM

Devices used on DIMM	1 DIMMx64/x72	2 DIMMsx64/x72
64 Mbit (2Mx8x4 banks)	128 MBytes	256 MBytes
64 Mbit (1Mx16x4 banks)	64 MBytes	128 MBytes
128 Mbit(4Mx8x4 banks)	256 MBytes	512 MBytes
128 Mbit(2Mx16x4 banks)	128 MBytes	256 MBytes
256 Mbit(8Mx8x4 banks)	512 MBytes	1 GBytes
256 Mbit(4Mx16x4 banks)	256 MBytes	512 MBytes
512 Mbit(8Mx16x4 banks)	512 MBytes	1 GBytes



DDR



1. The DIMM slot has a notch, so the DIMM memory module can only fit in one direction.
  2. Insert the DIMM memory module vertically into the DIMM slot. Then push it down.
  3. Close the plastic clip at both edges of the DIMM slots to lock the DIMM module.
- Reverse the installation steps when you wish to remove the DIMM module.

## DDR Introduction

Established on the existing SDRAM industry infrastructure, DDR (Double Data Rate) memory is a high performance and cost-effective solution that allows easy adoption for memory vendors, OEMs and system integrators.

DDR memory is a sensible evolutionary solution for the PC industry that builds on the existing SDRAM infrastructure, yet makes awesome advances in solving the system performance bottleneck by doubling the memory bandwidth. DDR SDRAM will offer a superior solution and migration path from existing SDRAM designs due to its availability, pricing and overall market support. PC2100 DDR memory (DDR266) doubles the data rate through reading and writing at both the rising and falling edge of the clock, achieving data bandwidth 2X greater than PC133 when running with the same DRAM clock frequency. With peak bandwidth of 2.1GB per second, DDR memory enables system OEMs to build high performance and low latency DRAM subsystems that are suitable for servers, workstations, high-end PC's and value desktop SMA systems. With a core voltage of only 2.5 Volts compared to conventional SDRAM's 3.3 volts, DDR memory is a compelling solution for small form factor desktops and notebook applications.

- When LED1 is ON, do not install/remove DDR from socket.
- Please note that the DIMM module can only fit in one direction due to the two notches. Wrong orientation will cause improper installation. Please change the insert orientation.

### Step 3: Install expansion cards

1. Read the related expansion card's instruction document before install the expansion card into the computer.
2. Remove your computer's chassis cover, screws and slot bracket from the computer.
3. Press the expansion card firmly into expansion slot in motherboard.
4. Be sure the metal contacts on the card are indeed seated in the slot.
5. Replace the screw to secure the slot bracket of the expansion card.
6. Replace your computer's chassis cover.
7. Power on the computer, if necessary, setup BIOS utility of expansion card from BIOS.
8. Install related driver from the operating system

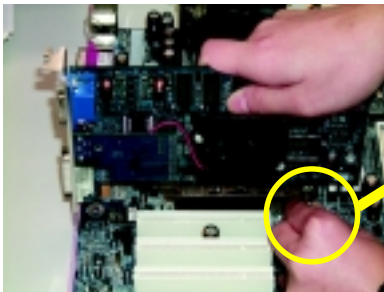

AGP Card



Please carefully pull out the small white-drawable bar at the end of the AGP slot when you try to install/ Uninstall the AGP card. Please align the AGP card to the onboard AGP slot and press firmly down on the slot .Make sure your AGP card is locked by the small white- drawable bar.

### Issues To Beware Of When Installing CNR

Please use standard CNR card like the one in order to avoid mechanical problem.



Standard CNR card

## Step 4: Connect ribbon cables, cabinet wires, and power supply

### Step4-1: I/O Back Panel Introduction

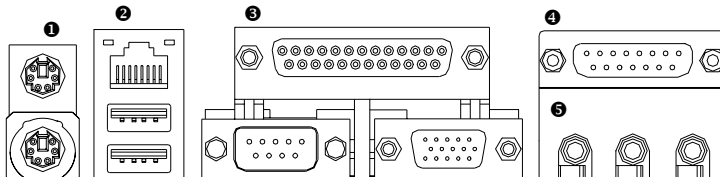

#### ❶ PS/2 Keyboard and PS/2 Mouse Connector

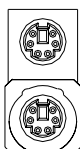

PS/2 Mouse Connector  
(6 pin Female)

PS/2 Keyboard Connector  
(6 pin Female)

➤ This connector supports standard PS/2 keyboard and PS/2 mouse.

#### ❷ USB & LAN Connector

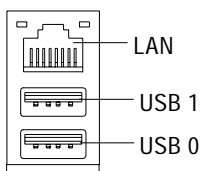

LAN

USB 1

USB 0

➤ Before you connect your device(s) into USB connector(s), please make sure your device(s) such as USB keyboard, mouse, scanner, zip, speaker..etc. Have a standard USB interface. Also make sure your OS (Win 95 with USB supplement, Win98, Windows 2000, Windows ME, Win NT with SP 6) supports USB controller. If your OS does not support USB controller, please contact OS vendor for possible patch or driver upgrade. For more information please contact your OS or device(s) vendors.

### 3 Parallel Port and VGA Port/COMA Port

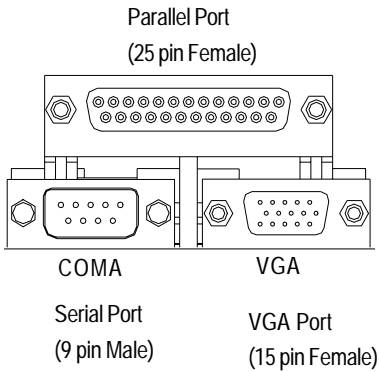

- This mainboard supports 1 standard COM port, 1 VGA port and 1 LPT port. Device like printer can be connected to LPT port ; mouse and modem etc can be connected to COM port.

### 4 Game /MIDI Ports

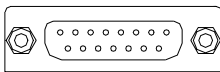

Joystick/ MIDI (15 pin Female)

- This connector supports joystick, MIDI keyboard and other relate audio devices.

### 5 Audio Connectors

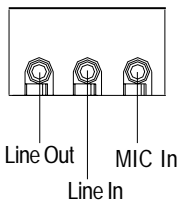

- After install onboard audio driver, you may connect speaker to Line Out jack, micro phone to MIC In jack. Device like CD-ROM , walkman etc can be connected to Line-In jack.

## Step4-2: Connectors Introduction

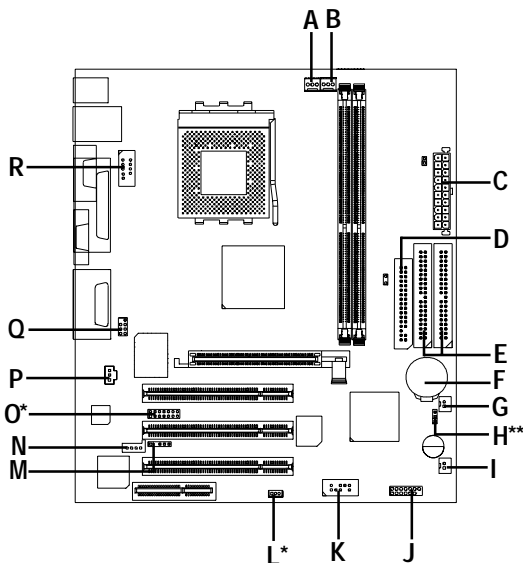

A) CPU_FAN	J) F_PANEL
B) SYS_FAN	K) USB1
C) ATX	L) WOL*
D) FDD	M) IR
E) IDE1/IDE2	N) CD_IN
F) BAT1	O) SCR*
G) CI	P) SPDIF
H) CLR_CMOS**	Q) F_AUDIO
I) S_IRQ	R) COMB

\*\*\* Supported on motherboard version: 1.0 only.

\*\*\*\* Supported on motherboard version: 1.1 only. Default doesn't include the "Shunter" to prevent from improper use this jumper. To clear CMOS, temporarily short 1-2 pin.

**A) CPU\_FAN (CPU FAN Connector)**

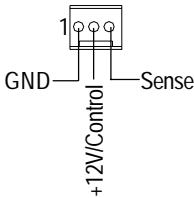

- Please note, a proper installation of the CPU cooler is essential to prevent the CPU from running under abnormal condition or damaged by overheating. The CPU fan connector supports Max. current up to 600mA .

**B) SYS\_FAN (System FAN Connector)**

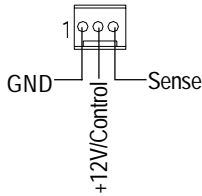

**N) CD\_IN (CD Audio Line In)**

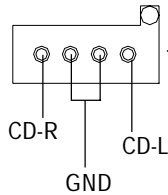

**C) ATX (ATX Power)**

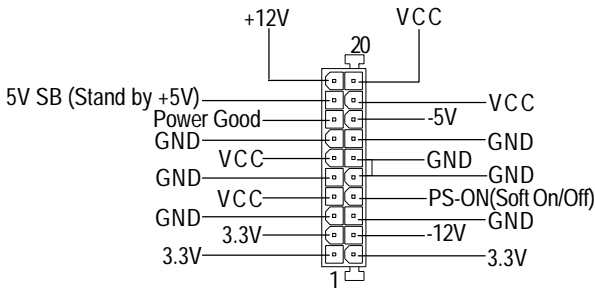

- AC power cord should only be connected to your power supply unit after ATX power cable and other related devices are firmly connected to the mainboard.

**D) FDD (Floppy Connector)**

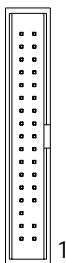

**R) COMB (COMB Port)**

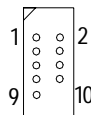

**E) IDE1/IDE2 [IDE1 (Primary), IDE2(Secondary) Connector]**

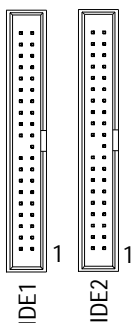

- Important Notice:  
Please connect first harddisk to IDE1 and connect CDROM to IDE2.

**K) USB1 (Front USB)**

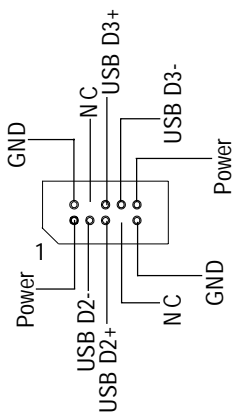

- Be careful with the polarity of the front panel USB connector. Check the pin assignment while you connect the front panel USB cable. Please contact your nearest dealer for optional front panel USB cable.



**M) IR (IR)**

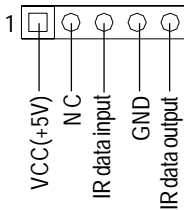

- Please note, Be careful with the polarity of the IR connector while you connect the IR. Please contact you nearest dealer for optional IR device.

**L) WOL (Wake On Lan)\***

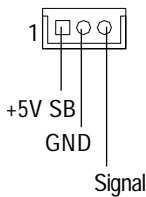

**G) CI (Case Open)**



**P) SPDIF (SPDIF)**

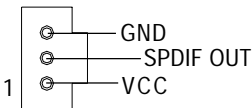

**I) S\_IRQ (Serial IRQ)**

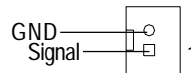

- The SPDIF output is capable of providing digital audio to external speakers or compressed AC3 data to an external Dolby Digital Decoder. Use this feature only when your stereo system has digital output function.

\*\*\*\* Supported on motherboard version: 1.0 only.

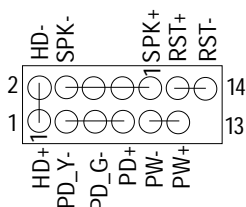
**J) F\_PANEL (2x7 pins connector)**

HD (IDE Hard Disk Active LED)	Pin 1: LED anode(+) Pin 2: LED cathode(-)
SPK (Speaker Connector)	Pin 1: VCC(+) Pin 2- Pin 3: NC Pin 4: Data(-)
RST (Reset Switch)	Open: Normal Operation Close: Reset Hardware System
PD+/PD_G-/PD_Y-(Power LED)	Pin 1: LED anode(+) Pin 2: LED cathode(-) Pin 3: LED cathode(-)
PW (Soft Power Connector)	Open: Normal Operation Close: Power On/Off

- Please connect the power LED, PC speaker, reset switch and power switch etc of your chassis front panel to the F\_PANEL connector according to the pin assignment above.

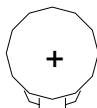
**F) BAT1 (Battery)****CAUTION**

- ❖ Danger of explosion if battery is incorrectly replaced.
- ❖ Replace only with the same or equivalent type recommended by the manufacturer.
- ❖ Dispose of used batteries according to the manufacturer's instructions.

**O) SCR (SCR connector)\***

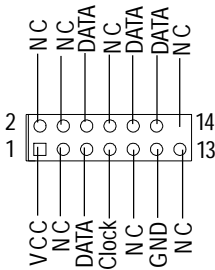

- Please note:  
This MB supports smart card reader. To enable smart card reader function an optional smart card reader box is required. Please contact your authorized distributor.  
Remove Floppy B before you plug smart card reader cable, you can not use smart card reader and Floppy B simultaneously.

**Q) F\_AUDIO (Front Audio)**

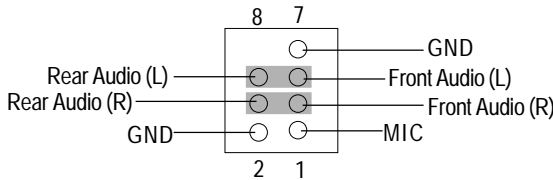

- If you want to use "Front Audio" connector, you must remove 3-4, 5-6 Jumper. In order to utilize the front audio header, your chassis must have front audio connector. Also please make sure the pin assignment on the cable is the same as the pin assignment on the MB header. To find out if the chassis you are buying support front audio connector, please contact your dealer.

**H) CLR\_CMOS (Clear CMOS Function)\*\***



1-2 close: Clear CMOS



2-3 close: Normal (Default)

- Please note: You may clear the CMOS data to its default values by this jumper.

\*\*\*\* Supported on motherboard version: 1.0 only.

\*\*\*\*\* Supported on motherboard version: 1.1 only. Default doesn't include the "Shunter" to prevent from improper use this jumper. To clear CMOS, temporarily short 1-2 pin.

## Chapter 3 BIOS Setup

BIOS Setup is an overview of the BIOS Setup Program. The program that allows users to modify the basic system configuration. This type of information is stored in battery-backed CMOS RAM so that it retains the Setup information when the power is turned off.

### ENTERING SETUP

Power ON the computer and press <Del> immediately will allow you to enter Setup.

### CONTROL KEYS

<↑>	Move to previous item
<↓>	Move to next item
<←>	Move to the item in the left hand
<→>	Move to the item in the right hand
<Esc>	Main Menu - Quit and not save changes into CMOS Status Page Setup Menu and Option Page Setup Menu - Exit current page and return to Main Menu
<+/PgUp>	Increase the numeric value or make changes
<-/PgDn>	Decrease the numeric value or make changes
<F1>	General help, only for Status Page Setup Menu and Option Page Setup Menu
<F2>	Reserved
<F3>	Reserved
<F4>	Reserved
<F5>	Restore the previous CMOS value from CMOS, only for Option Page Setup Menu
<F6>	Load the file-safe default CMOS value from BIOS default table
<F7>	Load the Optimized Defaults
<F8>	Q-Flash utility
<F9>	Reserved
<F10>	Save all the CMOS changes, only for Main Menu

## GETTINGHELP

### Main Menu

The on-line description of the highlighted setup function is displayed at the bottom of the screen.

### Status Page Setup Menu / Option Page Setup Menu

Press F1 to pop up a small help window that describes the appropriate keys to use and the possible selections for the highlighted item. To exit the Help Window press <Esc>.

## The Main Menu (For example: BIOS Ver. : F2)

Once you enter AMI BIOS CMOS Setup Utility, the Main Menu (Figure 1) will appear on the screen. The Main Menu allows you to select from eight setup functions and two exit choices. Use arrow keys to select among the items and press <Enter> to accept or enter the sub-menu.

AMIBIOS SIMPLE SETUP UTILITY - VERSION 2.00 (C) 2001 American Megatrends, Inc. All Rights Reserved			
STANDARD CMOS SETUP	INTEGRATED PERIPHERALS		
BIOS FEATURES SETUP	HARDWARE MONITOR & MISC SETUP		
CHIPSET FEATURES SETUP	SUPERVISOR PASSWORD		
POWER MANAGEMENT SETUP	USER PASSWORD		
PNP / PCI CONFIGURATION	IDE HDD AUTO DETECTION		
LOAD FAIL-SAFE DEFAULTS	SAVE & EXIT SETUP		
LOAD OPTIMIZED DEFAULTS	EXIT WITHOUT SAVING		
ESC: Quit	↑↓←→: Select Item	F5: Old Values	F6: Fail-Safe Values
F7: Optimized Values	F8: Q-Flash Utility		F10: Save & Exit
Time, Date , Hard Disk Type...			

Figure 1: Main Menu

- **Standard CMOS Features**  
This setup page includes all the items in standard compatible BIOS.
- **BIOS Features Setup**  
This setup page includes all the adjustable items of AMI special enhanced features.
- **Chipset Features Setup**  
This setup page includes all the adjustable items of chipset special features.

- **Power Management Setup**

This setup page includes all the adjustable items of Green function features.

- **PNP/PCI Configurations**

This setup page includes all the adjustable configurations of PCI & PnP ISA resources.

- **Load Fail-Safe Defaults**

Load Fail-Safe Defaults option loads preset system parameter values to set the system in its most stable configurations.

- **Load Optimized Defaults**

Load Optimized Defaults option loads preset system parameter values to set the system in its highest performance configurations.

- **Integrated Peripherals**

This setup page includes all onboard peripherals.

- **Hardware Monitor & MISC Setup**

This setup page is auto detect fan and temperature status.

- **Set Supervisor Password**

Set Change or disable password. It allows you to limit access to the system and/or BIOS setup.

- **Set User Password**

Set Change or disable password. It allows you to limit access to the system.

- **IDE HDD Auto Detection**

Automatically configure hard disk parameters.

- **Save & Exit Setup**

Save CMOS value settings to CMOS and exit setup.

- **Exit Without Saving**

Abandon all CMOS value changes and exit setup.

## Standard CMOS Features

AMIBIOS SETUP - STANDARD CMOS SETUP																																									
( C ) 2001 American Megatrends, Inc. All Rights Reserved																																									
System Date : Jan 08 2002 Tue																																									
System Time : 14:44:35																																									
<table border="1"> <thead> <tr> <th>TYPE</th> <th>SIZE</th> <th>CYLS</th> <th>HEAD</th> <th>PRECOMP</th> <th>LANDZ</th> <th>SECTOR</th> <th>MODE</th> </tr> </thead> <tbody> <tr> <td>Pri Master</td> <td>: Auto</td> <td></td> <td></td> <td></td> <td></td> <td></td> <td></td> </tr> <tr> <td>Pri Slave</td> <td>: Auto</td> <td></td> <td></td> <td></td> <td></td> <td></td> <td></td> </tr> <tr> <td>Sec Master</td> <td>: Auto</td> <td></td> <td></td> <td></td> <td></td> <td></td> <td></td> </tr> <tr> <td>Sec Slave</td> <td>: Auto</td> <td></td> <td></td> <td></td> <td></td> <td></td> <td></td> </tr> </tbody> </table>		TYPE	SIZE	CYLS	HEAD	PRECOMP	LANDZ	SECTOR	MODE	Pri Master	: Auto							Pri Slave	: Auto							Sec Master	: Auto							Sec Slave	: Auto						
TYPE	SIZE	CYLS	HEAD	PRECOMP	LANDZ	SECTOR	MODE																																		
Pri Master	: Auto																																								
Pri Slave	: Auto																																								
Sec Master	: Auto																																								
Sec Slave	: Auto																																								
Floppy Drive A : 1.44 MB 3 <sup>1/2</sup>	Base Memory : 640 Kb																																								
Floppy Drive B : Not Installed	Other Memory : 384 Kb																																								
	Extended Memory : 95 Mb																																								
Virus Protection : Disabled	Total Memory : 96 Mb																																								
Date is standard format	ESC : Exit																																								
Month : Jan - Dec	↑↓ : Select Item																																								
Day : 01- 31	PU / PD / + / - :Modify																																								
Year : 1990 - 2099	(Shift) F2 : Color																																								

Figure 2: Standard CMOS Setup

### Date

The date format is <week>, <month>, <day>, <year>.

- ▶▶ Week The week, from Sun to Sat, determined by the BIOS and is display only
- ▶▶ Month The month, Jan. Through Dec.
- ▶▶ Day The day, from 1 to 31 (or the maximum allowed in the month)
- ▶▶ Year The year, from 1990 through 2099

### **Time**

The times format in <hour> <minute> <second>. The time is calculated base on the 24-hour military time clock. For example, 1 p.m. is 13:00:00.

### **Primary Master, Slave / Secondary Master, Slave**

The category identifies the types of hard disk from drive C to F that has been installed in the computer. There are two types: auto type, and manual type. Manual type is user-definable; Auto type which will automatically detect HDD type.

Note that the specifications of your drive must match with the drive table. The hard disk will not work properly if you enter improper information for this category.

If you select User Type, related information will be asked to enter to the following items. Enter the information directly from the keyboard and press <Enter>. Such information should be provided in the documentation form your hard disk vendor or the system manufacturer.

▶▶ SIZE	HDD Size
▶▶ CYLS.	Number of cylinders
▶▶ HEADS	number of heads
▶▶ PRECOMP	write precomp
▶▶ LANDZONE	Landing zone
▶▶ SECTORS	number of sectors
▶▶ MODE	Logical block addressing

If a hard disk has not been installed select NONE and press <Enter>.

### **Floppy Drive A / Drive B**

The category identifies the types of floppy disk drive A or drive B that has been installed in the computer.

▶▶ Not Installed	No floppy drive installed
▶▶ 1.2M, 5.25 in.	5.25 inch AT-type high-density drive; 1.2M byte capacity (3.5 inch when 3 Mode is Enabled).
▶▶ 720K, 3.5 in.	3.5 inch double-sided drive; 720K byte capacity
▶▶ 1.44M, 3.5 in.	3.5 inch double-sided drive; 1.44M byte capacity.
▶▶ 2.88M, 3.5 in.	3.5 inch double-sided drive; 2.88M byte capacity.



## ☞ Virus Protection

If it is set to enable, the category will flash on the screen when there is any attempt to write to the boot sector or partition table of the hard disk drive. The system will halt and the following error message will appear in the mean time. You can run anti-virus program to locate the problem.

- ▶▶ Enabled      Activate automatically when the system boots up causing a warning message to appear when anything attempts to access the boot sector or hard disk partition table
- ▶▶ Disabled     No warning message to appear when anything attempts to access the boot sector or hard disk partition table (Default Value)

## ☞ Memory

The category is display-only which is determined by POST (Power On Self Test) of the BIOS.

### **Base Memory**

The POST of the BIOS will determine the amount of base (or conventional) memory installed in the system.

The value of the base memory is typically 512 K for systems with 512 K memory installed on the motherboard, or 640 K for systems with 640 K or more memory installed on the motherboard.

### **Other Memory**

This refers to the memory located in the 640 K to 1024 K address space. This is memory that can be used for different applications.

DOS uses this area to load device drivers to keep as much base memory free for application programs. Most use for this area is Shadow RAM.

### **ExtendedMemory**

The BIOS determines how much extended memory is present during the POST.

This is the amount of memory located above 1 MB in the CPU's memory address map.

## BIOS Features Setup

AMIBIOS SETUP - BIOS FEATURES SETUP	
( C ) 2001 American Megatrends, Inc. All Rights Reserved	
1st Boot Device	: Floppy
2nd Boot Device	: IDE-0
3rd Boot Device	: CDROM
S.M.A.R.T. for Hard Disks	: Disabled
Floppy Drive Seek	: Disabled
Password Check	: Setup
BIOS Flash Protection	: Auto
APIC Interrupt Mode	: APIC
ESC: Quit                    ↑↓←→: Select Item F1 : Help                    PU/PD/+/- : Modify F5 : Old Values            (Shift)F2: Color F6 : Fail-Safe            F7 : Optimized F8 : Q-Flash Utility	

Figure 3: BIOS Features Setup

### 1st / 2nd / 3rd Boot device

- ▶▶ Floppy                    Select your boot device priority by Floppy.
- ▶▶ ARMD-FDD                Select your boot device priority by ARMD-FDD.
- ▶▶ ARMD-HDD                Select your boot device priority by ARMD-HDD.
- ▶▶ CDROM                    Select your boot device priority by CDROM.
- ▶▶ SCSI                      Select your boot device priority by SCSI.
- ▶▶ NETWORK                 Select your boot device priority by NETWORK.
- ▶▶ Disabled                 Disable this function.
- ▶▶ IDE-0-3                  Select your boot device priority by IDE-0-3.
- ▶▶ USB FDD                  Select your boot device priority by USB FDD.
- ▶▶ USB CDROM                Select your boot device priority by USB CDROM.
- ▶▶ USB HDD                  Select your boot device priority by USB HDD.
- ▶▶ USB RMD-HDD             Select your boot device priority by USB RMD-HDD.
- ▶▶ USB RMD-FDD             Select your boot device priority by USB RMD-FDD.
- ▶▶ BBS-0-3                  Select your boot device priority by BBS-0-3.

### S.M.A.R.T. for Hard Disks

- ▶▶ Enabled                 Enable HDD S.M.A.R.T. Capability.
- ▶▶ Disabled                 Disable HDD S.M.A.R.T. Capability. (Default value)

---

## Floppy Drive Seek

During POST, BIOS will determine the floppy disk drive installed is 80 tracks. 720 K, 1.2 M and 1.44 M are all 80 tracks.

- ▶▶ Enabled      BIOS searches for floppy disk drive to determine it is 80 tracks. Note that BIOS can not tell from 720 K, 1.2 M or 1.44 M drive type as they are all 80tracks.
- ▶▶ Disabled      BIOS will not search for the type of floppy disk drive by track number. Note that there will not be any warning message if the drive installed is 360 K. (Default value)

## Password Check

Please refer to the detail on P.49

- ▶▶ Always        The user must enter correct password in order to access the system and/or BIOS Setup.
- ▶▶ Setup        The user must enter correct password in order to access BIOS setup utility. (Default Value)

## BIOS Flash Protection

This field lets you determine the states that flash BIOS

- ▶▶ Auto          BIOS enables flash write access automatically when updating BIOS data/DMI/ESCD. (Default Value)
- ▶▶ Enabled      During POST, DMI/ESCD would not be updated. But flash tools can update BIOS always.

## APICInterruptMode

- ▶▶ APIC          Through IOAPIC generate more IRQ for system use. (Default Value)
- ▶▶ PIC            Use AT standard IRQ controllers to generate IRQ.

When you already have IOAPIC enable system and want to upgrade the system please note, since running an IOAPIC enabled OS (like Windows NT, Windows 2000, Windows XP...) system with none IOAPIC HW support will cause the system to hang. Following are some situations users might run into:  
1.An IOAPIC enabled OS and change the BIOS setting from IOAPIC to PIC, this will cause your system to hang.

## Chipset Features Setup

We would not suggest you change the chipset default setting unless you really need it.

AMIBIOS SETUP - CHIPSET FEATURES SETUP	
( C ) 2001 American Megatrends, Inc. All Rights Reserved	
Top Performance	: Disabled
Configure DDR by SPD	: Enabled
DDR Frequency	: Auto
#DDR CAS# Latency	: 2.5
#Bank Interleave	: Disabled
DDR Command Rate	: 2T
AGP Mode	: 4X
AGP Comp. Driving	: Auto
Manual AGP Comp. Driving	: CB
AGP Fast Write	: Disabled
AGP Aperture Size	: 64MB
AGP Read Synchronization	: Disabled
PCI Delay Transaction	: Disabled
USB Controller	: All USB Port
USB Device Legacy Support	: Disabled
Port 64/60 Emulation	: Disabled
ESC: Quit            ↑↓←→: Select Item F1 : Help            PU/PD/+/- : Modify F5 : Old Values    (Shift)F2: Color F6 : Fail-Safe      F7 : Optimized F8 : Q-Flash Utility	

Figure 4: Chipset Features Setup

#These two items will be available when "Configure DDR by SPD" is set to Disabled.

### ☞ Top Performance

We would not suggest you change the default setting unless you really need it.

- ▶▶ Disabled      Top Performance Disable. (Default Value)
- ▶▶ Enabled        Top Performance Enable.
- ▶▶ Ultra          Set system performance to maximum level.

---

### ☞ **Configure DDR by SPD**

- ▶▶ Disabled      Disable Configure DDR by SPD.
- ▶▶ Enabled      Enable Configure DDR by SPD. (Default Value)

### ☞ **DDR Frequency**

- ▶▶ 200MHz      Set DDR Frequency to 200MHz.
- ▶▶ 266MHz      Set DDR Frequency to 266MHz.
- ▶▶ Auto          Set DDR Frequency to Auto. (Default Value)

### ☞ **DDR CAS# Latency**

- ▶▶ 2              For Fastest DDR DIMM module.
- ▶▶ 2.5            For Slower DDR DIMM module. (Default Value)

### ☞ **Bank Interleave**

- ▶▶ Disabled      Disable this function. (Default Value)
- ▶▶ 2-Way          Set Bank Interleave to 2-Way.
- ▶▶ 4-Way          Set Bank Interleave to 4-Way.

### ☞ **DDR Command Rate**

- ▶▶ 2T             Set DDR Command Rate to 2T Command. (Default Value)
- ▶▶ 1T             Set DDR Command Rate to 1T Command.

### ☞ **AGP Mode**

- ▶▶ 4X             Set AGP Mode to 4X. (Default Value)
- ▶▶ 1X             Set AGP Mode to 1X.
- ▶▶ 2X             Set AGP Mode to 2X.

### ☞ **AGP Comp. Driving**

- ▶▶ Auto          Set AGP Comp. Driving to Auto. (Default Value)
- ▶▶ Manual        Set AGP Comp. Driving to Manual.

If AGP Comp. Driving is Manual.

Manual AGP Comp. Driving : 00-FF

### **AGP Fast Write**

- ▶▶ Disabled    Disable AGP Fast Write. (Default Value)
- ▶▶ Enabled    Enable AGP Fast Write.

### **AGP Aperture Size**

- ▶▶ 4MB        Set AGP Aperture Size to 4MB.
- ▶▶ 8MB        Set AGP Aperture Size to 8 MB.
- ▶▶ 16MB       Set AGP Aperture Size to 16 MB.
- ▶▶ 32MB       Set AGP Aperture Size to 32 MB.
- ▶▶ 64MB       Set AGP Aperture Size to 64 MB. (Default Value)
- ▶▶ 128MB      Set AGP Aperture Size to 128 MB.
- ▶▶ 256MB      Set AGP Aperture Size to 256 MB.

### **AGP Read Synchronization**

- ▶▶ Enabled    Enable AGP Read Synchronization.
- ▶▶ Disabled    Disable AGP Read Synchronization. (Default Value)

### **PCI Delay Transaction**

- ▶▶ Enabled    Enable PCI Delay Transaction.
- ▶▶ Disabled    Disable PCI Delay Transaction.(Default Value)

### **USB Controller**

- ▶▶ Disabled    Disable USB Controller function.
- ▶▶ USB 1        Enable USB Port 1.
- ▶▶ USB 2        Enable USB Port 2.
- ▶▶ USB 1&2      Enable USB Port 1&2.
- ▶▶ All USB Port    Enable All USB Port. (Default Value)

**☞ USB Device Legacy Support**

- ▶▶ Keyboard/FDD      Set USB Device Legacy Support Keyboard / Floppy.
- ▶▶ KB/Mouse/FDD      Set USB Device Legacy Support Keyboard / Mouse /Floppy.
- ▶▶ Disabled            Disable USB Legacy Support Function. (Default Value)

**☞ Port 64/60 Emulation**

- ▶▶ Enabled            To use USB mouse under Win NT environment, set USB Legacy Support to KB/Mouse/FDD and USB Port 64/60 Emulation to enabled.
- ▶▶ Disabled            Disable this Function. (Default Value)

## Power Management Setup

AMIBIOS SETUP - POWER MANAGEMENT SETUP		
( C ) 2001 American Megatrends, Inc. All Rights Reserved		
ACPI Standby State	: S1/POS	RTC Alarm Date : 15
USB Dev Wakeup From S3-S5	: Disabled	RTC Alarm Hour : 12
Suspend Time Out(Minute)	: Disabled	RTC Alarm Minute : 30
IRQ3	: Monitor	RTC Alarm Second : 30
IRQ 4	: Monitor	
IRQ 5	: Ignore	
IRQ 7	: Monitor	
IRQ 9	: Ignore	
IRQ 10	: Ignore	
IRQ 11	: Ignore	
IRQ 13	: Ignore	
IRQ 14	: Monitor	
IRQ 15	: Ignore	
Power Button Function	: Instant off	
System After AC Back	: Last State	
Modem Ring On	: Enabled	ESC: Quit      ↑↓←→: Select Item
PME Event Wake Up	: Enabled	F1 : Help      PU/PD/+/- : Modify
Keyboard Wakeup From	: S1(Suspend)	F5 : Old Values (Shift)F2: Color
PS/2 Mouse Wakeup From	: S1(Suspend)	F6 : Fail-Safe    F7 : Optimized
Resume On RTC Alarm	: Disabled	F8 : Q-Flash Utility

Figure 5: Power Management Setup

### ☞ ACPI Standby State

- ▶▶ S1/POS      Set ACPI standby state to S1. (Default Value)
- ▶▶ S3/STR      Set ACPI standby state to S3.

### ☞ USB Dev Wakeup From S3~S5

- ▶▶ Enabled      Enable USB Dev Wakeup From S3-S5.
- ▶▶ Disabled      Disable USB Dev Wakeup From S3-S5. (Default Value)



---

### ☞ Suspend Time Out (Minute.)

- ▶▶ Disabled      Disable Suspend Time Out Function. (Default Value)
- ▶▶ 1              Enable Suspend Time Out after 1min.
- ▶▶ 2              Enable Suspend Time Out after 2min.
- ▶▶ 4              Enable Suspend Time Out after 4min.
- ▶▶ 8              Enable Suspend Time Out after 8min.
- ▶▶ 10             Enable Suspend Time Out after 10min.
- ▶▶ 20             Enable Suspend Time Out after 20min.
- ▶▶ 30             Enable Suspend Time Out after 30min.
- ▶▶ 40             Enable Suspend Time Out after 40min.
- ▶▶ 50             Enable Suspend Time Out after 50min.
- ▶▶ 60             Enable Suspend Time Out after 60min.

### ☞ IRQ 3~IRQ15

- ▶▶ Ignore        Ignore IRQ3 ~IRQ15.
- ▶▶ Monitor      Monitor IRQ3~IRQ15.

### ☞ Power Button Function

- ▶▶ Instant off    The user press the power button once, he can turn off the system.  
(Default Value)
- ▶▶ Suspend      The user press the power button once, then he can enter suspend mode.

### ☞ System After AC Back

- ▶▶ Last State    When AC-power back to the system, the system will return to the Last state  
before AC-power off. (Default Value)
- ▶▶ Power Off    When AC-power back to the system, the system will be in "Off" state.
- ▶▶ Power On    When AC-power back to the system, the system will be in "On" state.

### ☞ Modem Ring On

- ▶▶ Disabled      Disable Modem Ring on function.
- ▶▶ Enabled      Enable Modem Ring on function. (Default Value)

### **PME Event Wake Up**

- ▶▶ Disabled    Disable PME Event Wake Up.
- ▶▶ Enabled    Enabled PME Event Wake Up. (Default Value)

### **Keyboard Wakeup From**

- ▶▶ S1(Suspend)    Keyboard is able to Wakeup the system from S1(Suspend) state.  
(Default value)
- ▶▶ S1/S3    Keyboard is able to Wakeup the system from S1/S3 state.
- ▶▶ S1/S3/S4/S5    Keyboard is able to Wakeup the system from S1/S3/S4/S5 state.

### **PS/2 Mouse Wakeup From**

- ▶▶ S1(Suspend)    PS/2 Mouse is able to Wakeup the system from S1(Suspend) state.  
(Default value)
- ▶▶ S1/S3 PS/2    Mouse is able to Wakeup the system from S1/S3 state.
- ▶▶ S1/S3/S4/S5    PS/2 Mouse is able to Wakeup the system from S1/S3/S4/S5 state.

### **Resume On RTC Alarm**

You can set "Resume On RTC Alarm" item to enabled and key in Data/time to power on system.

- ▶▶ Disabled    Disable this function. (Default Value)
- ▶▶ Enabled    Enable alarm function to POWER ON system.

If RTC Alarm Lead To Power On is Enabled.

RTC Alarm Date:    Everyday, 1-31

RTC Alarm Hour:    0-23

RTC Alarm Minute : 0-59

RTC Alarm Second: 0-59

## PNP/PCI Configuration

AMIBIOS SETUP - PNP/PCI CONFIGURATION	
( C ) 2001 American Megatrends, Inc. All Rights Reserved	
OnChip VGA Frame Buffer	: 32MB
PCI Latency Timer	: 32
VGA Boot From	: PCI
PCI Slot 1 IRQ Priority	: Auto
PCI Slot 2 IRQ Priority	: Auto
PCI Slot 3 IRQ Priority	: Auto
ESC: Quit            ↑↓←→: Select Item F1 : Help             PU/PD/+/- : Modify F5 : Old Values    (Shift)F2: Color F6 : Fail-Safe      F7 : Optimized F8 : Q-Flash Utility	

Figure 6: PNP/PCI Configuration

### ☞ OnChip VGA Frame Buffer

- ▶▶ 8MB            Set OnChip VGA Frame Buffer to 8MB.
- ▶▶ 16MB          Set OnChip VGA Frame Buffer to 16MB.
- ▶▶ 32MB          Set OnChip VGA Frame Buffer to 32MB.(Default Value)
- ▶▶ None            Disable this function.

### ☞ PCILatency Timer

- ▶▶ 32              Set PCI Latency Timer to 32.(Default Value)
- ▶▶ 64              Set PCI Latency Timer to 64.
- ▶▶ 96              Set PCI Latency Timer to 96.
- ▶▶ 128             Set PCI Latency Timer to 128.
- ▶▶ 160             Set PCI Latency Timer to 160.

- ▶▶ 192 Set PCI Latency Timer to 192.
- ▶▶ 224 Set PCI Latency Timer to 224.
- ▶▶ 248 Set PCI Latency Timer to 248.

### ☞ **VGA Boot From**

- ▶▶ AGP Set VGA Boot from AGP VGA Card.
- ▶▶ PCI Set VGA Boot from PCI VGA Card. (Default Value)

### ☞ **PCI Slot1, 2, 3 IRQ Priority**

- ▶▶ Auto The system will reserved a free IRQ for PCI slot 1, 2, 3 device. (Default Value)
- ▶▶ 3 The system will reserved IRQ3 for PCI slot 1, 2, 3 device if no legacy ISA device using IRQ3.
- ▶▶ 4 The system will reserved IRQ4 for PCI slot 1, 2, 3 device if no legacy ISA device using IRQ4.
- ▶▶ 5 The system will reserved IRQ5 for PCI slot 1, 2, 3 device if no legacy ISA device using IRQ5.
- ▶▶ 7 The system will reserved IRQ7 for PCI slot 1, 2, 3 device if no legacy ISA device using IRQ7.
- ▶▶ 9 The system will reserved IRQ9 for PCI slot 1, 2, 3 device if no legacy ISA device using IRQ9.
- ▶▶ 10 The system will reserved IRQ10 for PCI slot 1, 2, 3 device if no legacy ISA device using IRQ10.
- ▶▶ 11 The system will reserved IRQ11 for PCI slot 1, 2, 3 device if no legacy ISA device using IRQ11.

## Load Fail-Safe Defaults

AMIBIOS SIMPLE SETUP UTILITY - VERSION 2.00 (C) 2001 American Megatrends, Inc. All Rights Reserved	
STANDARD CMOS SETUP	INTEGRATED PERIPHERALS
BIOS FEATURES SETUP	HARDWARE MONITOR & MISC SETUP
CHIPSET FEATURES SETUP	SUPERVISOR PASSWORD
POWER MANAGEMENT SETUP	
PNP / PCI CONFIGURATION	
LOAD FAIL-SAFE DEFAULTS	SAVE & EXIT SETUP
LOAD OPTIMIZED DEFAULTS	EXIT WITHOUT SAVING
ESC: Quit      ↑↓←→: Select Item      F5: Old Values      F6: Fail-Safe Values	
F7: Optimized Values      F8: Q-Flash Utility      F10: Save & Exit	
Load Fail-Safe Defaults	

Figure 7: Load Fail-Safe Defaults

### Load Fail-Safe Defaults

Fail-Safe defaults contain the most appropriate system parameter values of to configure the system to achieve maximum stability.

## Load Optimized Defaults

AMIBIOS SIMPLE SETUP UTILITY - VERSION 2.00 (C) 2001 American Megatrends, Inc. All Rights Reserved	
STANDARD CMOS SETUP	INTEGRATED PERIPHERALS
BIOS FEATURES SETUP	HARDWARE MONITOR & MISC SETUP
CHIPSET FEATURES SETUP	SUPERVISOR PASSWORD
POWER MANAGEMENT	
PNP / PCI CONFIGURATION	
LOAD FAIL-SAFE DEFAULTS	SAVE & EXIT SETUP
<b>LOAD OPTIMIZED DEFAULTS</b>	EXIT WITHOUT SAVING
ESC: Quit      ↑↓←→: Select Item      F5: Old Values      F6: Fail-Safe Values	
F7: Optimized Values      F8: Q-Flash Utility      F10: Save & Exit	
Load Optimized Defaults	

Figure 8: Load Optimized Defaults

### Load Optimized Defaults

Optimized defaults contain the most appropriate system parameter values to configure the system to achieve maximum performance.

## Integrated Peripherals

AMIBIOS SETUP - INTEGRATED PERIPHERALS	
( C ) 2001 American Megatrends, Inc. All Rights Reserved	
OnBoard FDC	: Auto
OnBoard Serial Port 1	: Auto
OnBoard Serial Port 2	: Auto
Serial Port2 Mode	: Normal
OnBoard Parallel Port	: Auto
Parallel Port Mode	: ECP
Parallel Port IRQ	: Auto
Parallel Port DMA	: Auto
OnBoard MIDI Port	: 300
MIDI Port IRQ	: 5
OnBoard Game Port	: Enabled
OnBoard IDE	: Both
OnBoard AC'97 Audio	: Auto
OnBoard MC'97 Modem	: Auto
Onboard Lan Chip	: Enabled
ESC : Quit                    ↑↓←→ : Select Item F1 : Help                    PU/PD/+/- : Modify F5 : Old Values            (Shift)F2: Color F6 : Fail-Safe            F7 : Optimized F8 : Q-Flash Utility	

Figure 9: Integrated Peripherals

### ☞ On Board FDC

- ☞ Auto                    Set On Board FDC to Auto. (Default Value)
- ☞ Disabled                Disable On Board FDC.
- ☞ Enabled                Enable On Board FDC.

### **Onboard Serial Port 1**

- ▶▶ Auto            BIOS will automatically setup the port 1 address. (Default Value)
- ▶▶ 3F8/COM1      Enable onboard Serial port 1 and address is 3F8.
- ▶▶ 2F8/COM2      Enable onboard Serial port 1 and address is 2F8.
- ▶▶ 3E8/COM3      Enable onboard Serial port 1 and address is 3E8.
- ▶▶ 2E8/COM4      Enable onboard Serial port 1 and address is 2E8.
- ▶▶ Disabled        Disable onboard Serial port 1.

### **Onboard Serial Port 2**

- ▶▶ Auto            BIOS will automatically setup the port 2 address. (Default Value)
- ▶▶ 3F8/COM1      Enable onboard Serial port 2 and address is 3F8.
- ▶▶ 2F8/COM2      Enable onboard Serial port 2 and address is 2F8.
- ▶▶ 3E8/COM3      Enable onboard Serial port 2 and address is 3E8.
- ▶▶ 2E8/COM4      Enable onboard Serial port 2 and address is 2E8.
- ▶▶ Disabled        Disable onboard Serial port 2.

### **Serial Port 2 Mode**

- ▶▶ Normal          Normal operation. (Default Value)
- ▶▶ IrDA            Onboard I/O chip supports IrDA.
- ▶▶ ASKIR          Onboard I/O chip supports ASKIR.

### **OnBoard Parallel port**

- ▶▶ 378            Enable On Board LPT port and address is 378.
- ▶▶ 278            Enable On Board LPT port and address is 278.
- ▶▶ 3BC            Enable On Board LPT port and address is 3BC.
- ▶▶ Auto            Set On Board LPT port is Auto. (Default Value)
- ▶▶ Disabled        Disable On Board LPT port.



---

## ☞ Parallel Port Mode

- ▶▶ EPP            Using Parallel port as Enhanced Parallel Port.
- ▶▶ ECP            Using Parallel port as Extended Capabilities Port. (Default Value)
- ▶▶ Normal        Normal Operation.
- ▶▶ EPP+ECP      Using Parallel port as Enhanced Parallel Port & Extended Capabilities Port.

## ☞ Parallel Port IRQ

- ▶▶ 7              Set Parallel Port IRQ to 7.
- ▶▶ Auto          Set Auto to parallel Port IRQ DMA Channel. (Default Value)
- ▶▶ 5              Set Parallel Port IRQ to 5.

## ☞ Parallel Port DMA

- ▶▶ Auto          Set Auto to parallel port mode DMA Channel. (Default Value)
- ▶▶ 3              Set Parallel Port DMA to 3.
- ▶▶ 1              Set Parallel Port DMA to 1.
- ▶▶ 0              Set Parallel Port DMA to 0.

## ☞ OnBoard MIDI Port

- ▶▶ 300            Set OnBoard MIDI Port to 300. (Default Value)
- ▶▶ 310            Set OnBoard MIDI Port to 310.
- ▶▶ 320            Set OnBoard MIDI Port to 320.
- ▶▶ 330            Set OnBoard MIDI Port to 330.
- ▶▶ Disabled      Disable this function.

## ☞ MIDI Port IRQ

- ▶▶ 5              Set MIDI Port IRQ to 5. (Default Value)
- ▶▶ 10             Set MIDI Port IRQ to 10.
- ▶▶ 11             Set MIDI Port IRQ to 11.

### **OnBoard Game Port**

- ▶▶ Disabled    Disable this function.
- ▶▶ Enabled    Enable Onboard Game Port function. (Default Value)

### **OnBoard IDE**

- ▶▶ Disabled    Disable OnBoard IDE.
- ▶▶ Both        Both Primary & Secondary IDE channel will be enabled. (Default Value)
- ▶▶ Primary    Only Primary IDE channel is enabled.
- ▶▶ Secondary   Only Secondary IDE channel is enabled.

### **OnBoard AC'97 Audio**

- ▶▶ Auto        Enable onboard AC'97 audio function. (Default Value)
- ▶▶ Disabled    Disable this function.

### **OnBoard MC'97 Modem**

- ▶▶ Auto        Enable On Board MC'97 Modem. (Default Value)
- ▶▶ Disabled    Disable On Board MC'97 Modem.

### **Onboard Lan Chip**

- ▶▶ Disabled    Disable this function.
- ▶▶ Enabled    Enable Onboard Lan Chip function. (Default Value)

## Hardware Monitor & MISC Setup

AMIBIOS SETUP - HARDWARE MONITOR & MISC SETUP	
( C ) 2001 American Megatrends, Inc. All Rights Reserved	
VCore Voltage	: Normal
CPU Host Clock (MHz)	: By Hw
Reset Case Open Status	: No
Case Status	: Open
CPU Temp.	: 35°C/ 95°F
System Temp.	: 33°C/ 91°F
CPU Fan Speed	: 5273 RPM
System Fan Speed	: 0 RPM
Vcore	: 1.632V
Vtt	: 1.264V
+3.300	: 3.312V
+5.000V	: +5.080V
+12.000V	: +11.840V
5VSB	: +4.919V
ESC: Quit            ↑↓←→: Select Item F1 : Help            PU/PD/+/- : Modify F5 : Old Values    (Shift)F2: Color F6 : Fail-Safe     F7 : Optimized F8 : Q-Flash Utility	

Figure 10: Hardware Monitor & MISC Setup

### ☞ VCore Voltage

- ▶▶ Normal            Normal Function.(Default Value)
- ▶▶ +5.0%            Set VCore voltage to +5.0%.
- ▶▶ +7.5%            Set VCore voltage to +7.5%.
- ▶▶ +10.0%          Set VCore voltage to +10.0%.

### ☞ CPU Host Clock (Mhz)

- ▶▶ By Hw            Set CPU Host Clock by Hw setup. (Default Value)
- ▶▶ 133              Set CPU Host Clock to 133MHz~200MHz.
- ▶▶ 100              Set CPU Host Clock to 100Mhz~167MHz.

### ☞ Reset Case Open Status

### **Case Status**

- ▶▶ If the case is closed, "Case Status" will show "Closed".
- ▶▶ If the case have been opened, "Case Status" will show "Open".
- ▶▶ If you want to reset "Case Status" value, set "Reset Case Open Status" to "Yes" and save CMOS, your computer will restart.

### **CPU / System Temp.**

- ▶▶ Detect CPU / System Temperature automatically.

### **CPU / System FAN Speed**

- ▶▶ Detect CPU / System Fan speed status automatically.

### **Current Voltage (V) Vcore / Vtt / +3.3V / +5V / +12V / 5VSB**

- ▶▶ Detect system's voltage status automatically.

## Set Supervisor / User Password

When you select this function, the following message will appear at the center of the screen to assist you in creating a password.

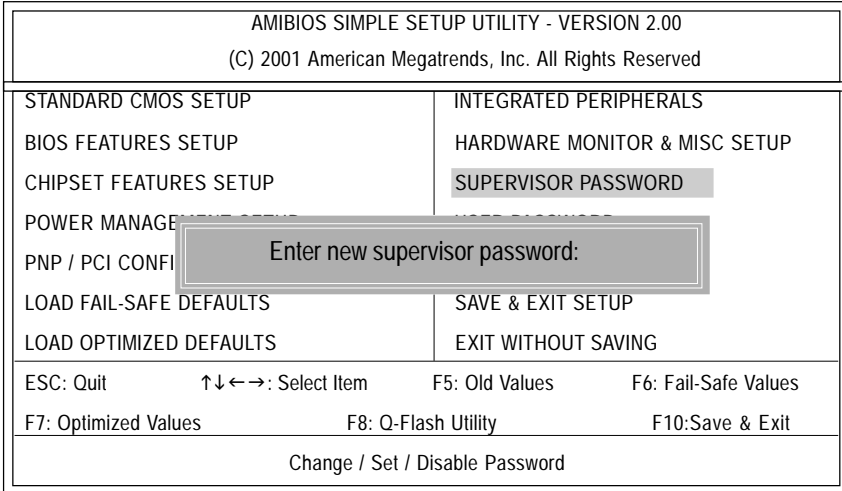

Figure 11: Password Setting

Type the password, up to six characters, and press <Enter>. You will be asked to confirm the password. Type the password again and press <Enter>. You may also press <Esc> to abort the selection and not enter a password.

To disable password, just press <Enter> when you are prompted to enter password. A message "PASSWORD DISABLED" will appear to confirm the password being disabled. Once the password is disabled, the system will boot and you can enter Setup freely.

The BIOS Setup program allows you to specify two separate passwords: a SUPERVISOR PASSWORD and a USER PASSWORD. When disabled, anyone may access all BIOS Setup program function. When enabled, the Supervisor password is required for entering the BIOS Setup program and having full configuration fields, the User password is required to access only basic items.

If you select "Always" at "Password Check" in BIOS Features Setup Menu, you will be prompted for the password every time the system is rebooted or any time you try to enter Setup Menu.

If you select "Setup" at "Password Check" in BIOS Features Setup Menu, you will be prompted only when you try to enter Setup.

## IDE HDD Auto Detection

AMBIOS SETUP - STANDARD CMOS SETUP																																									
( C ) 2001 American Megatrends, Inc. All Rights Reserved																																									
System Date : Jan 08 2002 Tue																																									
System Time : 14:44:35																																									
<table border="1"> <thead> <tr> <th>TYPE</th> <th>SIZE</th> <th>CYLS</th> <th>HEAD</th> <th>PRECOMP</th> <th>LANDZ</th> <th>SECTOR</th> <th>MODE</th> </tr> </thead> <tbody> <tr> <td>Pri Master</td> <td>: Auto</td> <td></td> <td></td> <td></td> <td></td> <td></td> <td></td> </tr> <tr> <td>Pri Slave</td> <td>: Auto</td> <td></td> <td></td> <td></td> <td></td> <td></td> <td></td> </tr> <tr> <td>Sec Master</td> <td>: Auto</td> <td></td> <td></td> <td></td> <td></td> <td></td> <td></td> </tr> <tr> <td>Sec Slave</td> <td>: Auto</td> <td></td> <td></td> <td></td> <td></td> <td></td> <td></td> </tr> </tbody> </table>		TYPE	SIZE	CYLS	HEAD	PRECOMP	LANDZ	SECTOR	MODE	Pri Master	: Auto							Pri Slave	: Auto							Sec Master	: Auto							Sec Slave	: Auto						
TYPE	SIZE	CYLS	HEAD	PRECOMP	LANDZ	SECTOR	MODE																																		
Pri Master	: Auto																																								
Pri Slave	: Auto																																								
Sec Master	: Auto																																								
Sec Slave	: Auto																																								
Floppy Drive A : 1.44 MB 3 <sup>1/2</sup>	Base Memory : 640 Kb																																								
Floppy Drive B : Not Installed	Other Memory : 384 Kb																																								
	Extended Memory : 95 Mb																																								
Virus Protection : Disabled	Total Memory : 96 Mb																																								
Date is standard format	ESC : Exit																																								
Month : Jan - Dec	↑↓ : Select Item																																								
Day : 01- 31	PU / PD / + / - :Modify																																								
Year : 1990 - 2099	(Shift) F2 : Color																																								

Figure 12: IDE HDD Auto Detection

Type "Y" will accept the H.D.D. parameter reported by BIOS.

Type "N" will keep the old H.D.D. parameter setup. If the hard disk cylinder number is over 1024, then the user can select LBA mode or LARGER mode for DOS partition larger than 528 MB.

## Save & Exit Setup

AMIBIOS SIMPLE SETUP UTILITY - VERSION 2.00	
(C) 2001 American Megatrends, Inc. All Rights Reserved	
STANDARD CMOS SETUP	INTEGRATED PERIPHERALS
BIOS FEATURES SETUP	HARDWARE MONITOR & MISC SETUP
CHIPSET FEATURES SETUP	SUPERVISOR PASSWORD
POWER MANAGEMENT SETUP	USER PASSWORD
PNP / PCI CONFIGURATION	SAVE & EXIT SETUP
LOAD FAIL-SAFE DEFAULTS	EXIT WITHOUT SAVING
LOAD OPTIMIZED DEFAULTS	
ESC: Quit      ↑↓←→: Select Item      F5: Old Values      F6: Fail-Safe Values	
F7: Optimized Values      F8: Q-Flash Utility      F10: Save & Exit	
Save Data to CMOS & Exit SETUP	

Figure 13: Save & Exit Setup

Type "Y" will quit the Setup Utility and save the user setup value to RTC CMOS.

Type "N" will return to Setup Utility.

## Exit Without Saving

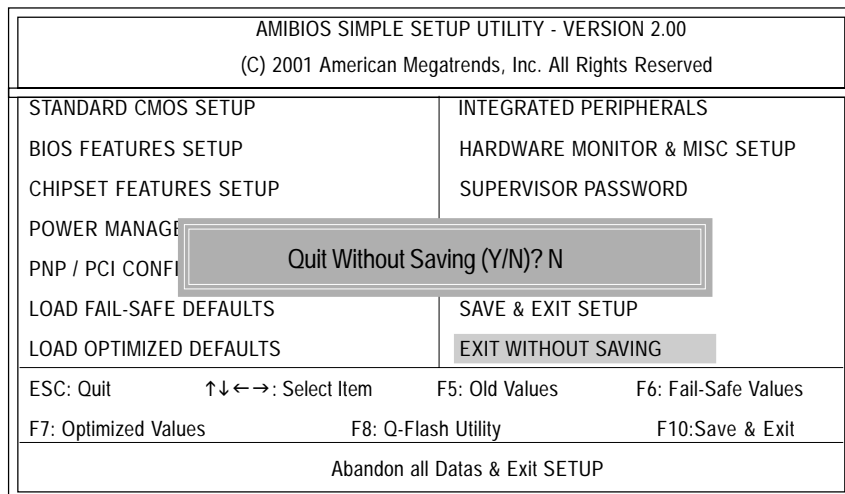

Figure 14: Exit Without Saving

Type "Y" will quit the Setup Utility without saving to RTC CMOS.

Type "N" will return to Setup Utility.



# Chapter 4 Technical Reference

## Block Diagram

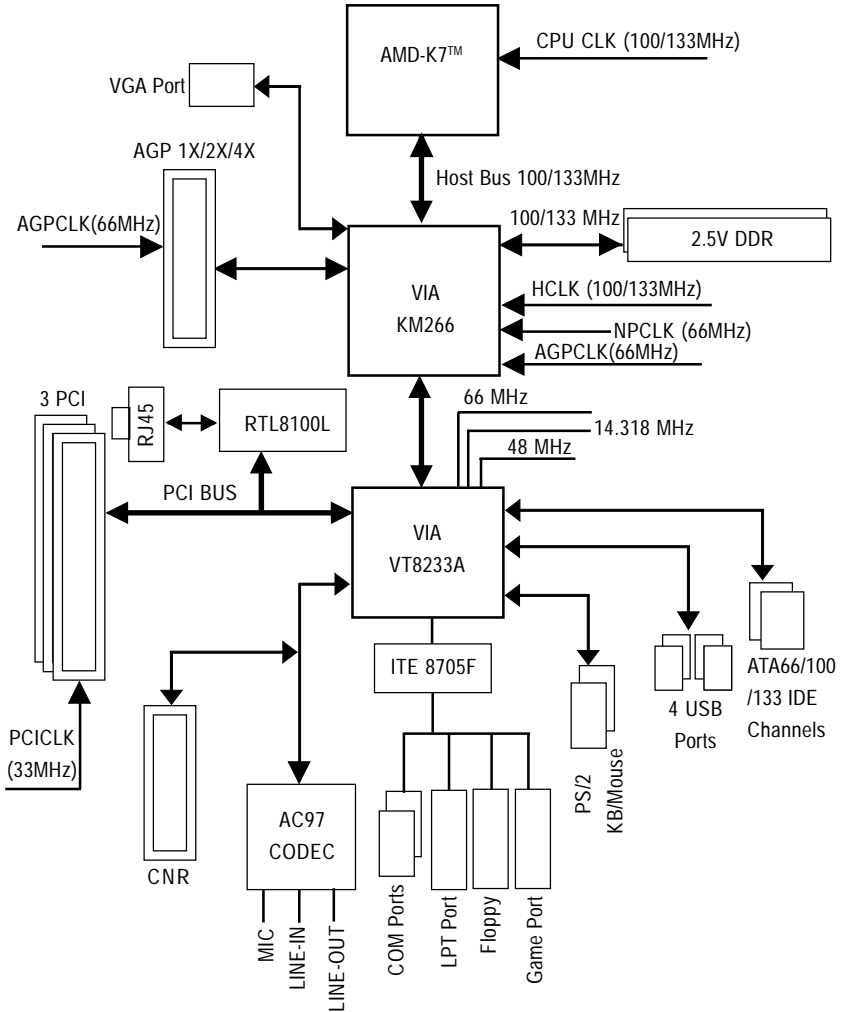

## Q-Flash Utility Introduction

### A. What is Q-Flash Utility?

Q-Flash utility is a pre-O.S. BIOS flash utility enables users to update its BIOS within BIOS mode, no more fooling around any OS.

### B. How to use Q-Flash?

a. After power on the computer, pressing <Del> immediately during POST (Power On Self Test) it will allow you to enter AMI BIOS CMOS SETUP, then press <F8> to enter Flash utility.

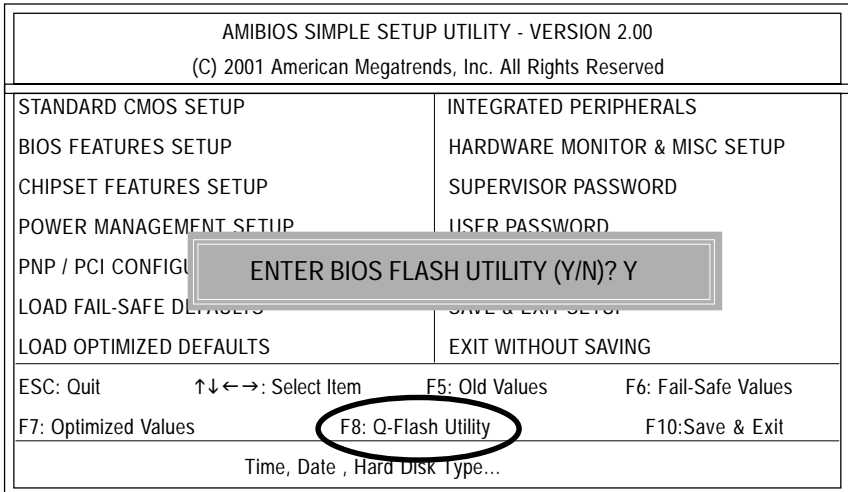

### b. Q-Flash Utility

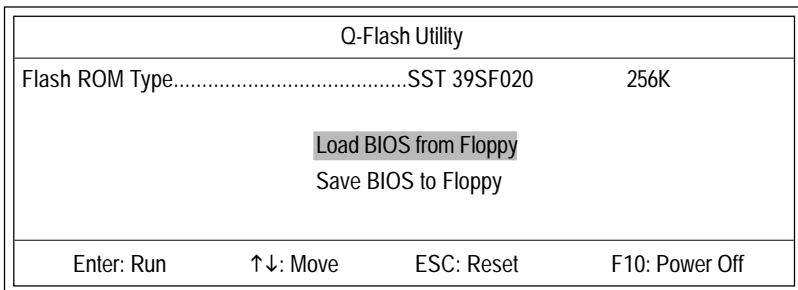

## Load BIOS From Floppy

 In the A:drive, insert the "BIOS" diskette, then Press Enter to Run.

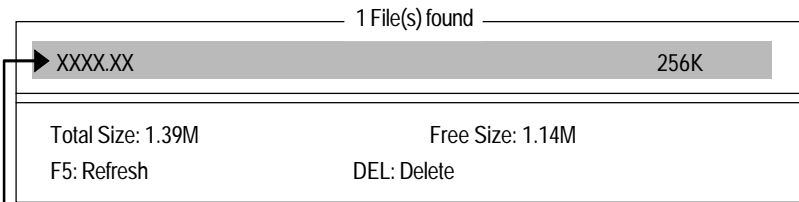

Where XXXX.XX is name of the BIOS file.

 Press Enter to Run.

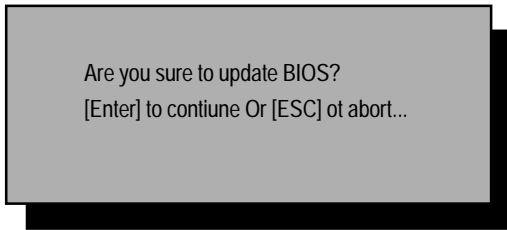

 Press Enter to Run.

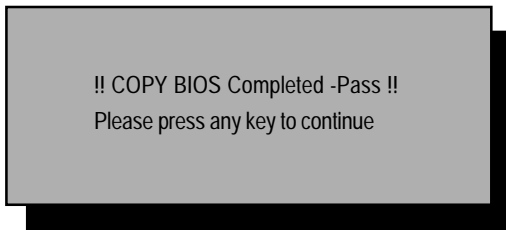

Congratulation! You have completed the flashed and now can restart system.

## @ BIOS™ Introduction

### **Gigabyte announces @ BIOS Windows BIOS live update utility**



Have you ever updated BIOS by yourself? Or like many other people, you just know what BIOS is, but always hesitate to update it? Because you think updating newest BIOS is unnecessary and actually you don't know how to update it.

Maybe not like others, you are very experienced in BIOS updating and spend quite a lot of time to do it. But of course you don't like to do it too much. First, download different BIOS from website and then switch the operating system to DOS mode. Secondly, use different flash utility to update BIOS. The above process is not a interesting job. Besides, always be carefully to store the BIOS source code correctly in your disks as if you update the wrong BIOS, it will be a nightmare.

Certainly, you wonder why motherboard vendors could not just do something right to save your time and effort and save you from the lousy BIOS updating work? Here it comes! Now Gigabyte announces @BIOS—the first Windows BIOS live update utility. This is a smart BIOS update software. It could help you to download the BIOS from internet and update it. Not like the other BIOS update software, it's a Windows utility. With the help of "@BIOS", BIOS updating is no more than a click.

Besides, no matter which mainboard you are using, if it's a Gigabyte's product\*, @BIOS help you to maintain the BIOS. This utility could detect your correct mainboard model and help you to choose the BIOS accordingly. It then downloads the BIOS from the nearest Gigabyte ftp site automatically. There are several different choices; you could use "Internet Update" to download and update your BIOS directly. Or you may want to keep a backup for your current BIOS, just choose "Save Current BIOS" to save it first. You make a wise choice to use Gigabyte, and @BIOS update your BIOS smartly. You are now worry free from updating wrong BIOS, and capable to maintain and manage your BIOS easily. Again, Gigabyte's innovative product erects a milestone in mainboard industries.

For such a wonderful software, how much it costs? Impossible! It's free! Now, if you buy a Gigabyte's motherboard, you could find this amazing software in the attached driver CD. But please remember, connected to internet at first, then you could have a internet BIOS update from your Gigabyte @BIOS.

## Easy TuneIII™ Introduction

### **Gigabyte announces *EasyTuneIII* Windows overdrive utility**



“Overdrive” might be one of the most common issues in computer field. But have many users ever tried it? The answer is probably “no”. Because “overdrive” is thought to be very difficult and includes a lot of technical know-how, sometimes “overdrive” is even considered as special skills found only in some enthusiasts.

But as to the experts in “overdrive”, what’s the truth? They may spend quite a lot of time and money to study, try and use many different hardware and software tools to do “overdrive”. And even with these technologies, they still learn that it’s quite a risk because the safety and stability of an “overdrive” system is unknown.

Now everything is different because of a Windows overdrive utility EasyTuneIII—announced by Gigabyte. This utility has totally changed the gaming rule of “overdrive”. This is the first overdrive utility suitable for both normal and power users. Users can choose either “Easy Mode” or “Advanced Mode” to run “overdrive” at their convenience. For users who choose “Easy Mode”, they just need to click “Auto Optimize” to have auto and immediate CPU overclocking. This software will then overdrive CPU speed automatically with the result being shown in the control panel. If someone prefers to “overdrive” by oneself, there is also another choice. Click “Advanced Mode” to enjoy “sport drive” class overclocking. In “Advanced Mode”, one can change the system bus speed in small increments to get ultimate system performance. And no matter which mainboard is used, if it’s a Gigabyte’s product”, EasyTuneIII helps to perform the best of system.

Besides, different from other traditional over-clocking methods, EasyTuneIII doesn’t require users to change neither BIOS nor hardware switch/jumper setting; on the other hand, they can do “overdrive” at only one click. Therefore, this is a safer way for “overdrive” as nothing is changed on software or hardware. If user runs EasyTuneIII over system’s limitation, the biggest lost is only to restart the computer again and the side effect is then well controlled. Moreover, if one well-performed system speed been tested in EasyTuneIII, user can “Save” this bus speed and “Load” it in next time. Obviously, Gigabyte EasyTuneIII has already turned the “overdrive” technology toward to a newer generation.

This wonderful software is now free bundled in Gigabyte motherboard attached driver CD. Users may make a test drive of “EasyTuneIII” to find out more amazing features by themselves.

## Chapter 5 Appendix

Picture below are shown in Windows ME (CD driver version 1.0)

### Appendix A: KM266 Chipset Drivers Installation

#### A. VIA 4 in 1 Service Pack Driver Utility:

Insert the driver CD-tittle that came with your motherboard into your CD-ROM driver, the driver CD-tittle will auto start and show the installation guide. If not, please double click the CD-ROM device icon in "My computer", and execute the setup.exe.

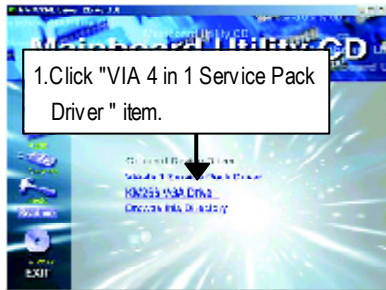

(1)

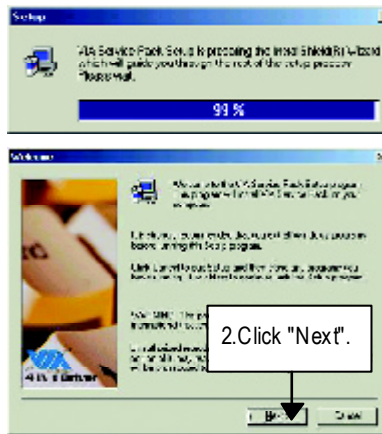

(2)

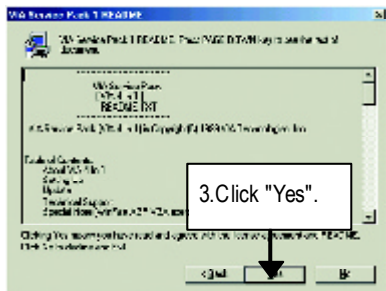

(3)

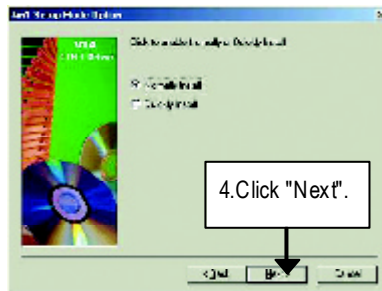

(4)



(5)



(6)

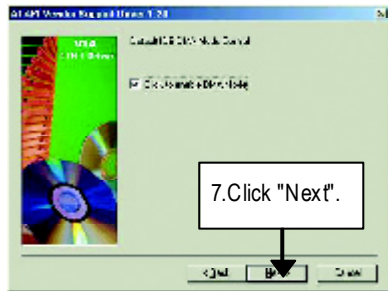

(7)



(8)



(9)

### B. KM266 VGA Driver:

Insert the driver CD-tittle that came with your motherboard into your CD-ROM driver, the driver CD-tittle will auto start and show the installation guide. If not, please double click the CD-ROM device icon in "My computer", and execute the setup.exe.

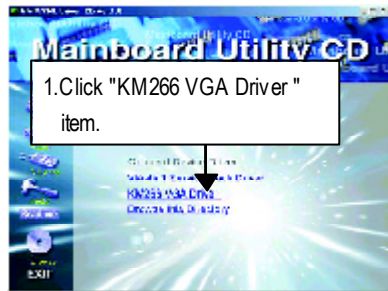

(1)

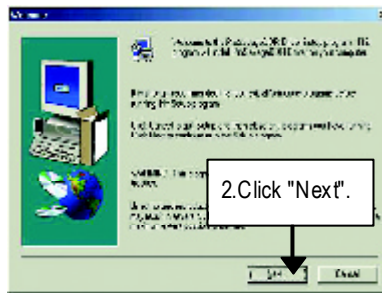

(2)

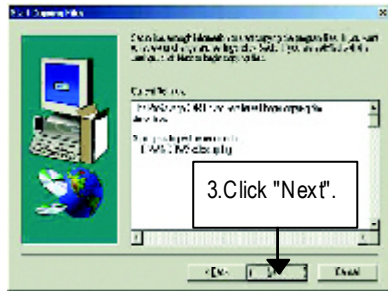

(3)



(4)



## Appendix B: Realtek AC'97 Audio Driver

Insert the driver CD-title that came with your motherboard into your CD-ROM driver, the driver CD-title will auto start and show the installation guide. If not, please double click the CD-ROM device icon in "My computer", and execute the setup.exe.

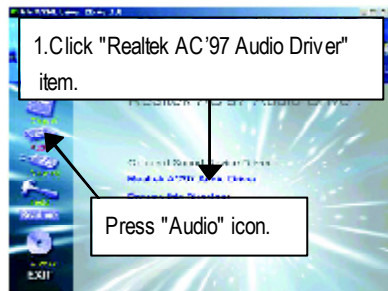

(1)



(2)



(3)

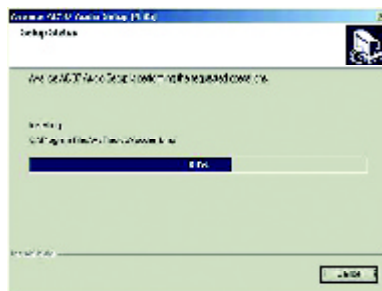

(4)



(5)

### Appendix C: RealTek 8139/8100 LAN Driver

Insert the driver CD-tite that came with your motherboard into your CD-ROM driver, the driver CD-tite will auto start and show the installation guide. If not, please double click the CD-ROM device icon in "My computer", and execute the setup.exe.



(1)



(2)

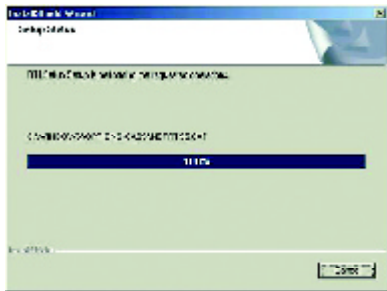

(3)



(4)

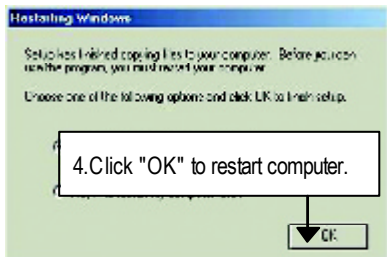

(5)

## Appendix D: EasyTuneIII Utilities Installation

Insert the driver CD-title that came with your motherboard into your CD-ROM driver, the driver CD-title will auto start and show the installation guide. If not, please double click the CD-ROM device icon in "My computer", and execute the setup.exe.

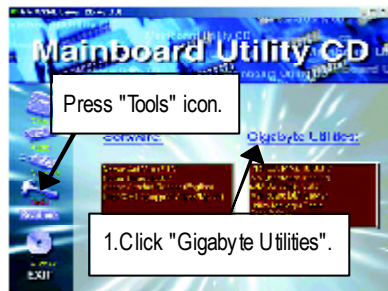

(1)

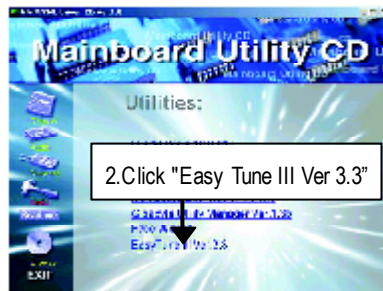

(2)

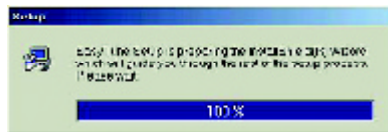

(3)



(4)



(5)



(6)

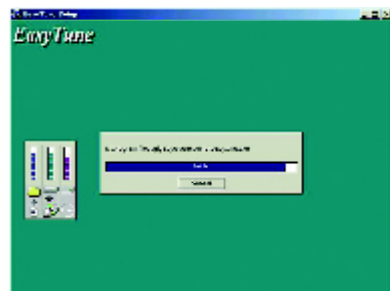

(7)



(8)

## Appendix E: BIOS Flash Procedure

BIOS update procedure:

If your OS is Win9X, we recommend that you used Gigabyte @BIOS™ Program to flash BIOS.

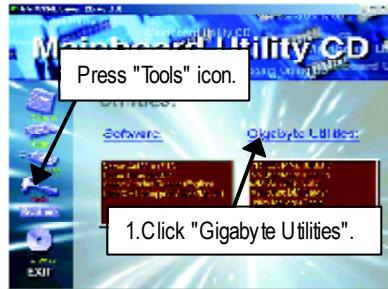

(1)

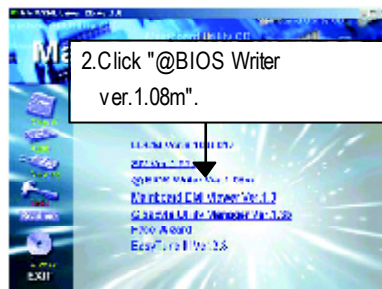

(2)



(3)

Methods and steps:

- I. Update BIOS through Internet
  - a. Click "Internet Update" icon
  - b. Click "Update New BIOS" icon
  - c. Select @BIOS™ sever ("Gigabyte @BIOS™ sever 1 in Taiwan" and "Gigabyte @BIOS™ sever 2 in Taiwan" are available for now, the others will be completed soon)
  - d. Select the exact model name on your motherboard
  - e. System will automatically download and update the BIOS.

II. Update BIOS NOT through Internet:

- a. Do not click "Internet Update" icon
- b. Click "Update New BIOS"
- c. Please select "All Files" in dialog box while opening the old file.
- d. Please search for BIOS unzip file, downloading from internet or any other methods (such as: 7VKML.F1).
- e. Complete update process following the instruction.

III. Save BIOS

In the very beginning, there is "Save Current BIOS" icon shown in dialog box. It means to save the current BIOS version.

IV. Check out supported motherboard and Flash ROM:

In the very beginning, there is "About this program" icon shown in dialog box. It can help you check out which kind of motherboard and which brand of Flash ROM are supported.

Note:

- a. In method I, if it shows two or more motherboard's model names to be selected, please make sure your motherboard's model name again. Selecting wrong model name will cause the system unbooted.
- b. In method II, be sure that motherboard's model name in BIOS unzip file are the same as your motherboard's. Otherwise, your system won't boot.
- c. In method I, if the BIOS file you need cannot be found in @BIOS™ server, please go onto Gigabyte's web site for downloading and updating it according to method II.
- d. Please note that any interruption during updating will cause system unbooted

We use GA-7VTX motherboard and Flash841 BIOS flash utility as example.

Please flash the BIOS according to the following procedures if you are now under the DOS mode.

Flash BIOS Procedure:

STEP 1:

- (1) Please make sure you have set "Auto" for BIOS Feature Setup (BIOS Flash Protection). For more detail please refer to page 31.
- (2) Please make sure your system has installed the extraction utility such as winzip or pkunzip.  
Firstly you have to install the extraction utility such as winzip or pkunzip for unzip the files. Both of these utilities are available on many shareware download pages like <http://www.shareware.cnet.com>

STEP 2: Make a DOS boot diskette. (See example: Windows 98 O.S.)

Beware: Windows ME/2000 are not allowed to make a DOS boot diskette.

- (1) With an available floppy disk in the floppy drive. Please leave the diskette "UN-write protected" type. Double click the "My Computer" icon from Desktop, then click "3.5 diskette (A)" and right click to select "Format (M)"

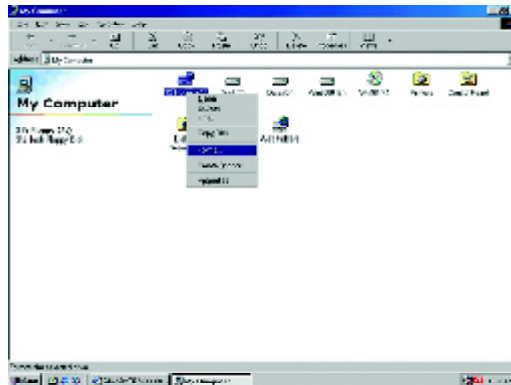

- (2) Select the "Quick (erase)" for Format Type, and pick both "Display summary when finished" and "Copy system files", after that press "Start". That will format the floppy and transfer the needed system files to it.

Beware: This procedure will erase all the prior data on that floppy, so please proceed accordingly.

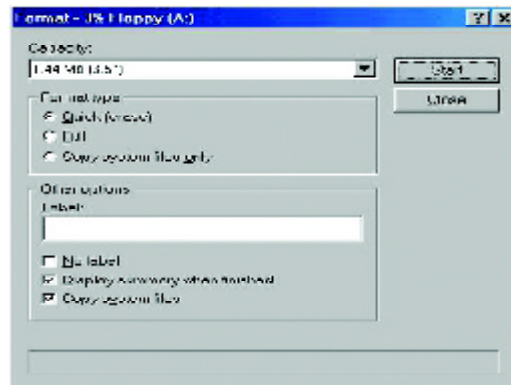

- (3) After the floppy has been formatted completely, please press "Close".

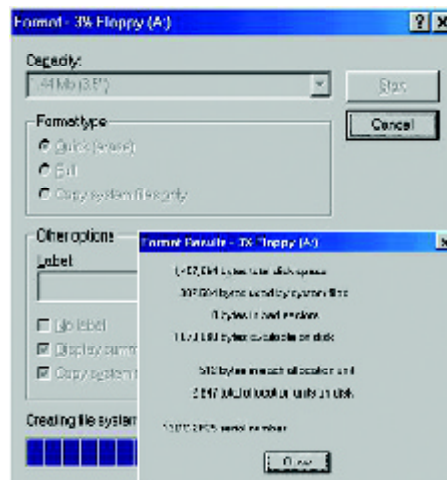



STEP 3: Download BIOS and BIOS utility program.

(1) Please go to Gigabyte website <http://www.gigabyte.com.tw/index.html>, and click "Support".



(2) From Support zone, click the "Motherboards BIOS & Drivers".

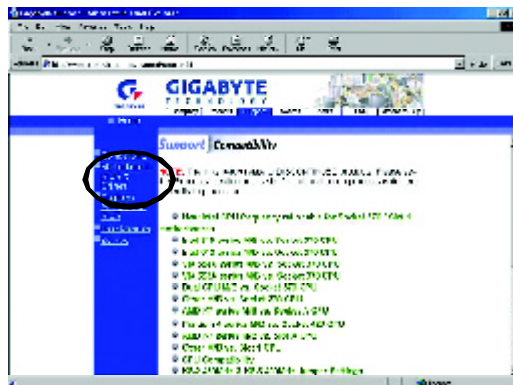

- (3) We use GA-7VTX motherboard as example. Please select GA-7VTX by Model or Chipset optional menu to obtain BIOS flash files.

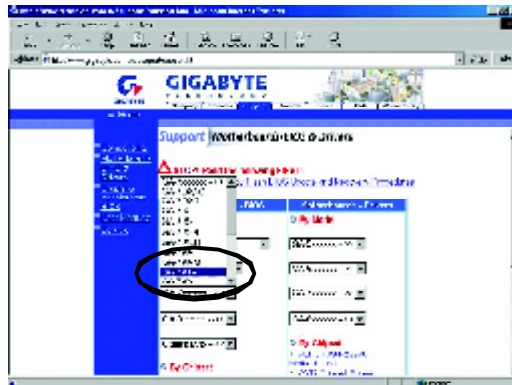

- (4) Select an appropriate BIOS version (For example: F4), and click to download the file. It will pop up a file download screen, then select the "Open this file from its current location" and press "OK".

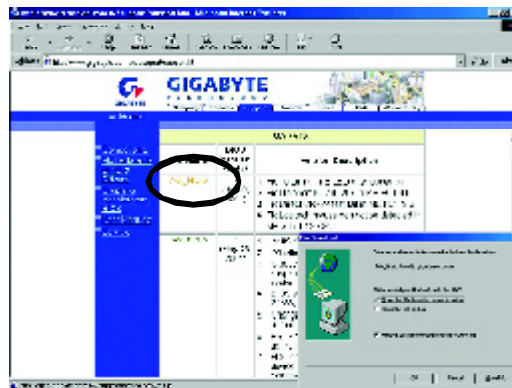

(5) At this time the screen shows the following picture, please click "Extract" button to unzip the files.

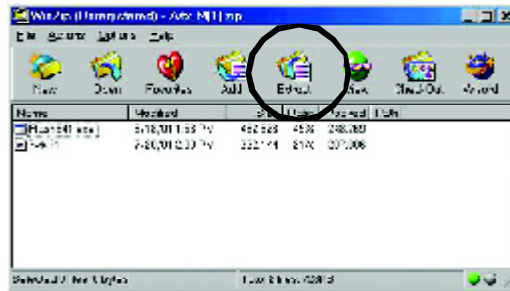

(6) Please extract the download files into the clean bootable floppy disk A mentioned in STEP 2, and press "Extract".

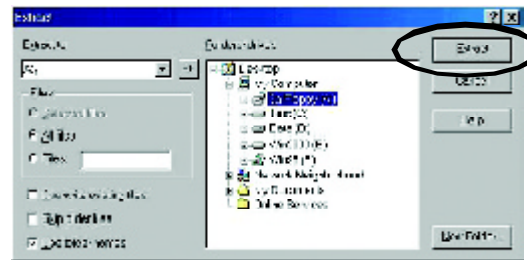

STEP 4: Make sure the system will boot from the floppy disk.

- (1) Insert the floppy disk (contains bootable program and unzip file) into the floppy drive A. Then, restart the system. The system will boot from the floppy disk. Please press <DEL> key to enter BIOS setup main menu when system is boot up.

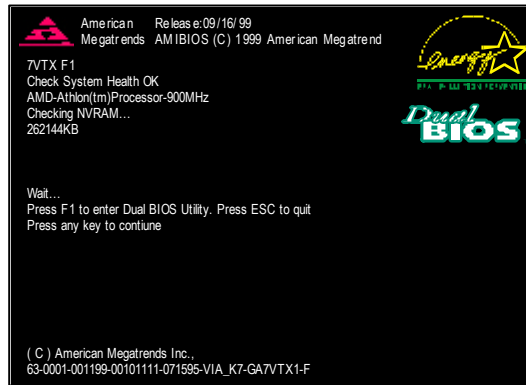

- (2) Once you enter the BIOS setup utility, the main menu will appear on the screen. Use the arrows to highlight the item "BIOS FEATURES SETUP".

AMIBIOS SIMPLE SETUP UTILITY - VERSION 1.24b	
(C) 1999 American Megatrends, Inc. All Rights Reserved	
STANDARD CMOS SETUP	INTEGRATED PERIPHERALS
<b>BIOS FEATURES SETUP</b>	HARDWARE MONITOR & MISC SETUP
CHIPSET FEATURES SETUP	SUPERVISOR PASSWORD
POWER MANAGEMENT SETUP	USER PASSWORD
PNP / PCI CONFIGURATION	IDE HDD AUTO DETECTION
LOAD BIOS DEFAULTS	SAVE & EXIT SETUP
LOAD SETUP DEFAULTS	EXIT WITHOUT SAVING
ESC: Quit    ↓↓↓↓↓: Select Item    (Shift)F2: Change Color    F5: Old Values	
F6: Load BIOS Defaults    F7: Load Setup Defaults    F10: Save & Exit	
Time, Date, Hard Disk Type...	

- (3) Press "Enter" to enter "BIOS FEATURES SETUP" menu. Use the arrows to highlight the item "1st Boot Device", and then use the "Page Up" or "Page Down" keys to select "Floppy".

AMIBIOS SETUP - BIOS FEATURES SETUP	
(C) 2001 American Megatrends, Inc. All Rights Reserved	
1st Boot Device : Floppy	
2nd Boot Device : IDE-0	
3rd Boot Device : CDROM	
S.M.A.R.T. for Hard Disks : Disabled	
BootUp Num-Lock : On	ESC: Quit      ↓ ↓ ↓ ↓ : Select Item
Floppy Drive Seek : Disabled	F1 : Help      PU/PD/+/- : Modify
Password Check : Setup	F5 : Old Values (Shift)F2: Color
	F6 : Load BIOS Defaults
	F7 : Load Setup Defaults

- (4) Press "ESC" to go back to previous screen. Use the arrows to highlight the item "SAVE & EXIT SETUP" then press "Enter". System will ask "SAVE to CMOS and EXIT (Y/N)?" Press "Y" and "Enter" keys to confirm. Now the system will reboot automatically, the new BIOS setting will be taken effect next boot-up.

AMIBIOS SIMPLE SETUP UTILITY - VERSION 1.24b	
(C) 2001 American Megatrends, Inc. All Rights Reserved	
STANDARD CMOS SETUP	INTEGRATED PERIPHERALS
BIOS FEATURES SETUP	HARDWARE MONITOR & MISC SETUP
CHIPSET FEATURES SETUP	SUPERVISOR PASSWORD
POWER MANAGEMENT SETUP	USER PASSWORD
PNP / PCI CONF	SAVE to CMOS and EXIT (Y/N)? Y
LOAD BIOS DEFAULTS	SAVE & EXIT SETUP
LOAD SETUP DEFAULTS	EXIT WITHOUT SAVING
ESC: Quit      ↓ ↓ ↓ ↓ : Select Item      (Shift)F2 : Change Color      F5: Old Values	
F6: Load BIOS Defaults      F7: Load Setup Defaults      F10: Save & Exit	
Save Data to CMOS & Exit SETUP	

STEP 5: BIOS flashing.

- (1) After the system boot from floppy disk, type "A:\> dir/w" and press "Enter" to check the entire files in floppy A. Then type the "BIOS flash utility" and "BIOS file" after A:\>. In this case you have to type "A:\> Flash841 7VTX.F4" and then press "Enter".

```
Starting Windows 98...

Microsoft(R) Windows98
© Copyright Microsoft Corp 1981-1999

A:\> dir/w
Volume in drive A has no label
Volume Serial Number is 16EB-353D
Directory of A:\
COMMAND.COM  7VTX.F4  FLASH841.EXE
              3 file(s)  838,954 bytes
              0 dir(s)  324,608 bytes free

A:\> Flash841 7VTX.F4
```

- (2) Now screen appears the following Flash Utility main menu. Press "Enter", the highlighted item will locate on the model name of the right-upper screen. Right after that, press "Enter" to start BIOS Flash Utility.

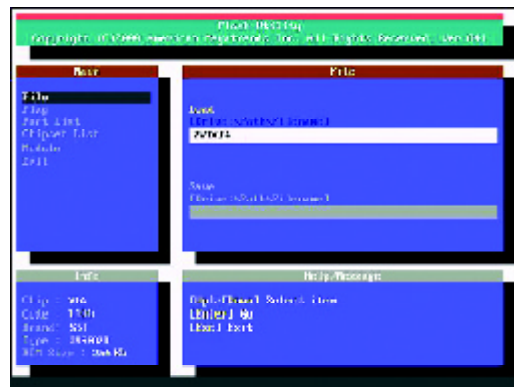

- (3) It will pop up a screen and asks "Are you sure to flash the BIOS?" Press [Enter] to continue the procedure, or press [ESC] to quit.

Beware: Please do not turn off the system while you are upgrading BIOS. It will render your BIOS corrupted and system totally inoperative.

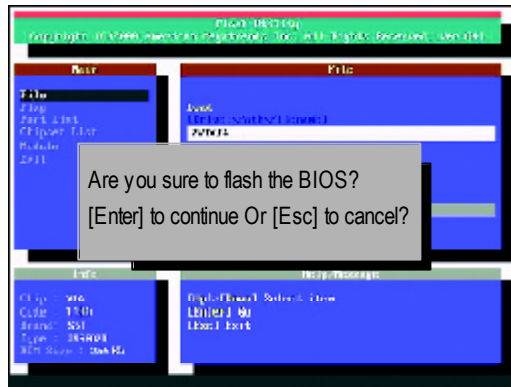

- (4) The BIOS flash completed. Please press [ESC] to exit Flash Utility.



STEP 6: Load BIOS defaults.

Normally the system redetects all devices after BIOS has been upgraded. Therefore, we highly recommend reloading the BIOS defaults after BIOS has been upgraded. This important step resets everything after the flash.

- (1) Take out the floppy diskette from floppy drive, and then restart the system. The boot up screen will indicate your motherboard model and current BIOS version.



- (2) Don't forget to press <DEL> key to enter BIOS setup again when system is boot up. Use the arrows to highlight the item "LOAD SETUP DEFAULTS" then press "Enter". System will ask "Load Setup Defaults (Y/N)?" Press "Y" and "Enter" keys to confirm.

AMIBIOS SIMPLE SETUP UTILITY - VERSION 1.24b (C) 2001 American Megatrends, Inc. All Rights Reserved	
STANDARD CMOS SETUP	INTEGRATED PERIPHERALS
BIOS FEATURES SETUP	HARDWARE MONITOR & MISC SETUP
CHIPSET FEATURES SETUP	SUPERVISOR PASSWORD
POWER MANAGEMENT SETUP	MODE BIOS SETUP
PNP / PCI CONFIGURATION	Load Setup Defaults? (Y/N)?N
LOAD BIOS DEFAULTS	SAVE & EXIT SETUP
LOAD SETUP DEFAULTS	EXIT WITHOUT SAVING
ESC: Quit    ↑ ↓ ← → : Select Item    (Shift)F2: Change Color    F5: Old Values F6: Load BIOS Defaults    F7: Load Setup Defaults    F10: Save & Exit	
Load Setup Defaults	



- (3) Use the arrows to highlight the item "SAVE & EXIT SETUP" and press "Enter". System will ask "SAVE to CMOS and EXIT (Y/N)?" Press "Y" and "Enter" keys to confirm. Now the system will reboot automatically, the new BIOS setting will be taken effect next boot-up.

AMIBIOS SIMPLE SETUP UTILITY - VERSION 1.24b (C) 2001 American Megatrends, Inc. All Rights Reserved	
STANDARD CMOS SETUP	INTEGRATED PERIPHERALS
BIOS FEATURES SETUP	HARDWARE MONITOR & MISC SETUP
CHIPSET FEATURES SETUP	SUPERVISOR PASSWORD
POWER MANAGEMENT SETUP	USER PASSWORD
PNP / PCI CONF	SAVE & EXIT SETUP
LOAD BIOS DEFAULTS	EXIT WITHOUT SAVING
LOAD SETUP DEFAULTS	
ESC: Quit      ↑ ↓ ← → : Select Item      (Shift)F2 : Change Color      F5: Old Values F6: Load BIOS Defaults      F7: Load Setup Defaults      F10: Save & Exit	
Save Data to CMOS & Exit SETUP	

- (4) Congratulate you have accomplished the BIOS flash procedure.

**Appendix F: Acronyms**

Acronyms	Meaning
ACPI	Advanced Configuration and Power Interface
APM	Advanced Power Management
AGP	Accelerated Graphics Port
AMR	Audio Modem Riser
ACR	Advanced Communications Riser
BIOS	Basic Input / Output System
CPU	Central Processing Unit
CMOS	Complementary Metal Oxide Semiconductor
CRIMM	Continuity RIMM
CNR	Communication and Networking Riser
DMA	Direct Memory Access
DMI	Desktop Management Interface
DIMM	Dual Inline Memory Module
DRM	Dual Retention Mechanism
DRAM	Dynamic Random Access Memory
DDR	Double Data Rate
ECP	Extended Capabilities Port
ESCD	Extended System Configuration Data
ECC	Error Checking and Correcting
EMC	Electromagnetic Compatibility
EPP	Enhanced Parallel Port
ESD	Electrostatic Discharge
FDD	Floppy Disk Device
FSB	Front Side Bus
HDD	Hard Disk Device
IDE	Integrated Dual Channel Enhanced
IRQ	Interrupt Request
I/O	Input / Output
IOAPIC	Input Output Advanced Programmable Input Controller
ISA	Industry Standard Architecture
LAN	Local Area Network

to be continued.....

---

Acronyms	Meaning
LBA	Logical Block Addressing
LED	Light Emitting Diode
MHz	Megahertz
MIDI	Musical Interface Digital Interface
MTH	Memory Translator Hub
MPT	Memory Protocol Translator
NIC	Network Interface Card
OS	Operating System
OEM	Original Equipment Manufacturer
PAC	PCI A.G.P. Controller
POST	Power-On Self Test
PCI	Peripheral Component Interconnect
RIMM	Rambus in-line Memory Module
SCI	Special Circumstance Instructions
SECC	Single Edge Contact Cartridge
SRAM	Static Random Access Memory
SMP	Symmetric Multi-Processing
SMI	System Management Interrupt
USB	Universal Serial Bus
VID	Voltage ID

---

**Technical Support/RMA Sheet**

Customer/Country:	Company:	Phone No.:
Contact Person:	E-mail Add. :	

Model name/Lot Number:	PCB revision:
BIOS version:	O.S./A.S.:

Hardware Configuration	Mfs.	Model name	Size:	Driver/Utility:
CPU				
Memory				
Brand				
Video Card				
Audio Card				
HDD				
CD-ROM / DVD-ROM				
Modem				
Network				
AMR / CNR				
Keyboard				
Mouse				
Power supply				
Other Device				

Problem Description:

---



---