Cyclone Pentium *System Board Manual*

MICRONICS

Document Number: 06-00321-01, Rev. 3A

August 1997

45365 Northport Loop West, Fremont, CA. 94538-6417

Copyright Notices

Copyright © 1997 Micronics Computers, Inc. The information contained in the Cyclone PCI/ISA Pentium system board manual has been carefully checked and is believed to be accurate. Micronics assumes no responsibility for any inaccuracies that may be contained in this document. Micronics makes no commitments to update or to keep the information in this manual at a current level when changes are made to the product.

Micronics reserves the right to make improvements to this document and/or product at any time and without notice. All Rights Reserved. No part of this document may be photocopied, reproduced, translated, or reduced to any medium or machine form without prior, written consent from Micronics.

Portions of the Manual

Portions of this manual were copied (with permission) from Phoenix Technologies, Ltd. All rights reserved.

Trademarks

IBM is a registered trademark of International Business Machines. Microsoft and Windows are registered trademarks of Microsoft Corporation. Intel, PCI and NLX are registered trademarks of Intel Corporation. All other product names mentioned herein are used for identification purposes only and may be the trademarks of their respective companies.

Table of Contents

Introduction	5
Features	6
Software Compatibility	7
Before You Begin	8
Chapter 1 - Quick Installation	9
Installing the Cyclone	9
Chapter 2 - Configuring the Cyclone	11
Static Electricity	11
Environment Considerations	11
Cyclone System Board Diagram	12
Riser Card Diagram	13
Jumper Settings	14
Chapter 3 - Installing the Cyclone	19
Introduction	19
System Memory Support	19
Installing the Cyclone	20
Equipment Required	20
System Memory	21
Adding Memory	21
Memory Configurations	22
Installing DIMMs	23
Removing DIMMs	23
Installing a CPU	24
Installing a PCI Peripheral Card	25
Installing an ISA Peripheral Card	26
Connecting the Graphics Option	27

Chapter 4 - The BIOS Setup Utility	29
Configuration	29
Initial Bootup	29
Setup	29
Running the Setup Procedure	31
Setting the Main Screen	31
Setting the Advanced Screen	36
Security Screen	39
Power Screen	42
Boot Screen	45
Exit Screen	46
Chapter 5 - Installing Device Drivers	47
About Device Drivers	47
Installing the Graphics Drivers	47
Appendix A - Technical Information	49
Specifications	49
Environmental Specifications	51
Temperature Range	51
Relative Humidity	51
Battery Disposal	52
Support and Information Services	53
Technical Support	53
Appendix B - Post Messages	55
Appendix C - Beep and POST Codes	57

Appendix D - Hard Disk Drive Types	61
Appendix E - Updating the System BIOS	63
Appendix F - Warranties and Notices	65
Limited Warranty	65
Non-Warranty Service	66
FCC Statement	67
Glossary	68
Index	72

List of Figures

Figure 1.1: Power-Up Screen	10
Figure 2.1: Cyclone System Board	12
Figure 3.1: Installing a 168-Pin DIMM	23
Figure 3.2: Installing a PCI Peripheral Card	25
Figure 3.3: Installing an ISA Peripheral Card	26
Figure 4.1: Power-Up Screen	30
Figure 4.2: CMOS Main Screen	31
Figure 4.3: IDE Device Submenu	34
Figure 4.4: Advanced Screen	36
Figure 4.5: Advanced Screen Submenu	38
Figure 4.6: Security Screen	39
Figure 4.7: Supervisor Password Submenu	40
Figure 4.8: Power Screen	42
Figure 4.9: Boot Screen	45
Figure 4.10: Exit Screen	46

List of Tables

Table 2.1: System Speed Selection	14
Table 2.2: CPU Voltage Selection	14
Table 2.3: Clear CMOS Settings	15
Table 2.4: Onboard Graphics Settings (W1)	15
Table 2.5: Onboard Graphics Settings (W22)	15
Table 2.6: Burst Mode Settings	16
Table 2.7: Cyclone Connector Settings	16
Table 2.8: Riser Card Connector Settings	17
Table 3.1: Memory Configurations	22
Table A.1: Support and Information Services	54

Introduction

Thank you for choosing the Cyclone system board. The Cyclone is a 32-bit computing solution using the new NLX form factor, targeted at the industry's most demanding workstation applications.

Based on the SIS 5597 chipset, the Cyclone supports the latest the Intel Pentium® processor with MMX technology and the AMD processors. Other features of the SIS 5597 chipset include Universal Serial Bus support and onboard 64-bit graphics.

The new NLX form factor allows better access to upgradeable components inside the system and provides easy installation and removable of the system board. The Cyclone system board design comes with a Riser Card linked by an edge connector with an extended pin-out. Viewed from the front, the riser card sits along the right edge of the system board.

Micronics builds all products to exacting standards, using the highest quality components available. We are proud to provide this system board and believe you will be pleased with your purchase.

Features

The Cyclone includes the following features:

- ▲ Single ZIF Socket 7
 - Intel Pentium® chip 75-200MHz
 - Intel Pentium® chip with MMX™ 166-233MHz
 - AMD-K5™ PR75 to PR166
 - AMD-K6™ 166 to 233MHz
 - Switching Regulator
 - Integrated VRM
- ▲ Silicon Integrated Systems SIS 5597 chipset
 - SMC FDC37C669 Ultra I/O chip
- ▲ 256K Pipeline Burst SRAM
 - 512K Pipeline Burst SRAM (optional)
- ▲ Two 32-bit PCI slots
 - Two 16-bit ISA slots
 - One is a shared PCI/ISA slot
- ▲ Two 3.3V unbuffered 64-bit DIMM sockets
 - Maximum memory - 384MB
 - Supports FPM, EDO and SDRAM memory
- ▲ Ultra DMA/33 IDE
- ▲ SIS 5597 64-bit graphics with up to 4MB memory
- ▲ NLX form factor

Software Compatibility

The Cyclone system board has been thoroughly tested for compatibility with a variety of operating systems and environments, including:

- ▲ Microsoft
 - DOS 6.2x
 - Windows 95
 - Windows NT 3.5x
 - Windows NT 4.0

- ▲ IBM
 - OS/2 Warp 3.0
 - OS/2 Warp 4.0

- ▲ SCO
 - UNIXWare 2.1.1
 - Open Server 5.02
 - UNIX 3.2.4.2

Before You Begin

This manual will familiarize you with the features, installation and use of your Cyclone. There are several symbols and conventions used throughout this manual to help draw your attention to a feature or to focus on important information:



When you see the Magnifying Glass, it refers to something you should take a closer look at before proceeding further.



When you see the Exclamation Mark, it gives important information on avoiding damage.

Common Names

DIMM	Dual Inline Memory Module
DRAM	Dynamic Random Access Memory
EDO	Extended Data Out
FPM	Fast Page Mode
IDE	Integrated Drive Electronics
PCI	Peripheral Component Interconnect
SDRAM	Synchronous DRAM
SIMM	Single Inline Memory Module
USB	Universal Serial Bus
VRM	Voltage Regulator Module

Chapter

1

Quick Installation

We know that many experienced people prefer to read as little of the documentation as possible. If this sounds like you, here's the short form to get up and running quickly.

Installing the Cyclone



STATIC!

Before handling the Cyclone, be properly grounded by using a special wrist or ankle strap, or touch a safely grounded object.

1. Make backup copies of your installation and configuration diskettes.
2. Ground yourself to prevent damaging static discharge by using an antistatic wrist or ankle strap, or touch a safely grounded metal object.
3. Remove both the system board and Riser card from its packaging.
4. Configure and verify both the system board and Riser card's jumper settings (refer to Jumper Settings in Chapter 2).
5. Install the CPU and the system memory.
6. Connect the Riser card to the edge connector on system board
7. Install the system board in the chassis and make all necessary case connections.
8. Connect any ISA and/or PCI add-on peripherals to the slots on the Riser card.
9. Connect any optional devices.
10. Turn the computer on and press the <F2> key when you see the screen shown in Figure 1.1.
11. Set the time and date. Adjust the BIOS settings to match your configuration. If installing an IDE drive, select the IDE device you wish to configure. Press

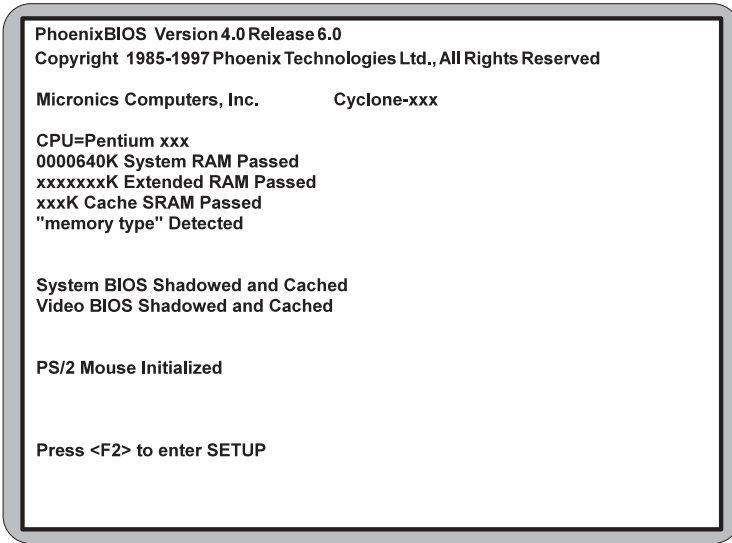

Figure 1.1: Power-Up Screen

ENTER with Autotype Fixed Disk selected and the BIOS will automatically configure the drive for you (refer to Chapter 4).

12. After you have configured the Main Setup menu, make any desired setting configurations in the Advanced and Security menu. When finished, go to the exit screen, select "Save Changes and Exit" and you are finished with the BIOS configuration (see Chapter 4).
13. Install the graphics device drivers (optional). Refer to Chapter 5.

Configuring the Cyclone

Although the Cyclone system board is packaged in materials that are designed to protect it from physical damage and static electricity, it is important to use care while unpacking the board and setting it up.

Static Electricity

The Cyclone is shipped from the factory in an antistatic bag. To reduce the possibility of damage from static discharge, it is important to neutralize any static charges your body may have accumulated before handling the board.

The best way to do this is to ground yourself using a special antistatic wrist or ankle strap. If you do not have an antistatic strap available, touch both of your hands to a safely grounded object, such as the power supply or chassis of a computer that is connected to the power socket. After you have grounded yourself, ground the Cyclone board via one of the solder pads that surround its mounting holes. When you remove the Cyclone from its packaging, place it on top of the antistatic bag, and carefully inspect the board for damage which might have occurred during shipment.

Environment Considerations

Make sure the finished computer system is in an area with good ventilation. The system should not be in direct sunlight, near heaters, or exposed to moisture, dust, or dirt.

Cyclone System Board

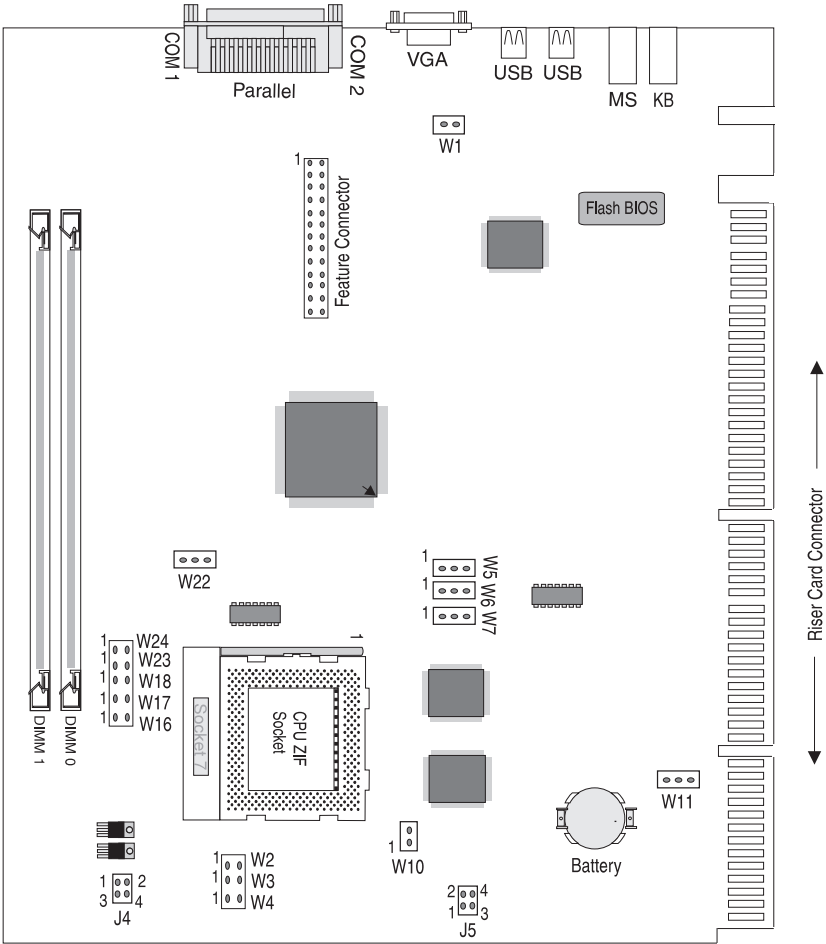

Figure 2-1. Cyclone System Board Diagram

Riser Card

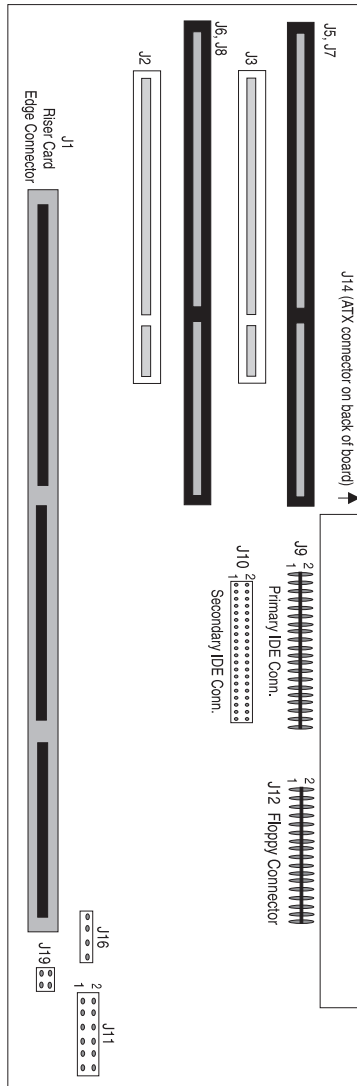

Figure 2-2. Cyclone Rise Card Diagram

Jumper Settings

This section provides the jumper settings for the Cyclone system board. Table 2-1 lists the Intel and AMD CPU speed settings and the jumper settings that select these speeds.

CPU Speed	Bus Speed	W2	W3	W4	W5	W6	W7
75 MHz	50 x 1.5	Open	Open	Close	2-3	2-3	2-3
90 MHz	60 x 1.5	Open	Open	Close	1-2	2-3	2-3
100 MHz	66 x 1.5	Open	Open	Close	2-3	1-2	2-3
100 MHz	50 x 2.0	Close	Open	Open	2-3	2-3	2-3
120 MHz	60 x 2.0	Close	Open	Open	1-2	2-3	2-3
133 MHz	66 x 2.0	Close	Open	Open	2-3	1-2	2-3
150 MHz	60 x 2.5	Close	Close	Open	1-2	2-3	2-3
150 MHz	50 x 3.0	Open	Close	Open	2-3	2-3	2-3
166 MHz	66 x 2.5	Close	Close	Open	2-3	1-2	2-3
180 MHz	60 x 3.0	Open	Close	Open	1-2	2-3	2-3
200 MHz*	66 x 3.0	Open	Close	Open	2-3	1-2	2-3
233 MHz	66 x 3.5	Open	Open	Open	2-3	1-2	2-3

Table 2-1: System Speed Selection

Table 2-2 lists the jumper settings to set the CPU voltage for the following processors: Intel 54C, K5, P55C and AMD K6-166, K6-200 and K6-233.

CPU Voltage	W16	W17	W18	W23	W24
3.5V (P54C, K5)	Open	Open	Open	Close	Open
2.8V (P55C)	Close	Open	Open	Open	Open
2.9V (K6-200, K6-166)	Open	Close	Open	Open	Open
3.2V (K6-233)*	Open	Open	Close	Open	Open
2.1V (Reserved)	Open	Open	Open	Open	Close

*Default Setting

Table 2-2: CPU Voltage Selection

Table 2-3 lists the settings to clear the CMOS. With your computer's power off, close pins 2-3, wait ten seconds and place the jumper back on pins 1-2. (The jumper must be placed back on pins 1-2 for the system to function properly.)

NOTE: This will reset all BIOS default settings. Any changes you have made will be lost.

Jumper	Function	Settings
W11	Normal (default)	1-2
	Clear CMOS	2-3

Table 2-3: Clear CMOS Settings

Table 2-4 lists the settings for the onboard graphics. Disable jumpers W1 and W22 if you want to use your own VGA card.

Jumper	Function	Settings
W1	Internal VGA Disabled	ON
	Internal VGA Enabled (default)	OFF

Table 2-4: Onboard Graphics Settings

Table 2-5 lists the settings for the onboard graphics. Disable jumpers W1 and W22 if you want to use your own VGA card.

Jumper	Function	Settings
W22	Internal VGA Disabled (Ext. VGA)	1-2
	Internal VGA Enabled (default)	2-3

Table 2-5: Onboard Graphics Settings

Table 2-6 lists the settings for the Linear or Interleave Burst Mode.

Jumper	Function	Settings
W10	Linear Burst Mode (Cyrux) Interleave Burst Mode (Intel, AMD)	ON OFF

Table 2-6: Burst Mode Settings

Table 2-7 lists the Cyclone connectors and their functions.

Connector	Function	Notes
J2-J3	DIMM Sockets	3.3V Unbuffered
J4	CPU Fan Connector	
J5	Chassis Connector	
J6	Serial Port (COM 1)	Can be disabled at the CMOS configuration screen
J7	Serial Port (COM 2)	Can be disabled at the CMOS configuration screen
J8	Parallel Port Connector	Can be disabled at the CMOS configuration screen
J10	Feature Connector	
J11	VGA Connector	
J20	PS/2 Keyboard Connector	
J21	PS/2 Mouse Connector	
J22	USB Connector	USB Port 0
J23	USB Connector	USB Port 1

Table 2-7 Cyclone Connector Settings

Table 2-8 lists the Riser card connectors and their functions.

Connector	Function	Notes
J1	Riser Card Edge Connector	
J2	PCI Slot #1	
J3	PCI Slot #2	
J5, J7	ISA Slot #1	
J6, J8	ISA Slot #2	
J9	Primary IDE Connector	
J10	Secondary IDE Connector	
J11	Front Panel Connector	
"	Speaker	1 - Speaker; 2 - +5V DC
"	Hard Drive/SCSI LED	3 - Positive; 4 - Negative
"	Reset	5 - Reset; 6 - Ground
"	Power-On Switch	8 - +5V DC; 9 - Ground
"	Power-On LED	11 - Ground; 12 - +5V DC
J12	Floppy Drive Connector	
J14	ATX Power Connector	
J16	Hard Drive/SCSI Display Connector	
J17	Infrared Connector	Optional
J19	CPU Fan	

Table 2-8: Riser Card Connector Settings

Installing the Cyclone

Introduction

This chapter explains how to install the Cyclone system board, memory, CPU and peripherals.

WARNING: *Before installing or removing any peripherals or components, make sure you have a clear work space and that you adhere to all antistatic precautions described in Chapter 1. Micronics recommends that only trained technicians install and configure the system board.*

Damage which occurs to the board while adding or removing peripherals or components may void the warranty. If problems arise while installing peripherals, contact the computer dealer where you purchased the peripheral or Micronics' Technical Support Department.

System Memory Support

The flexibility of the Cyclone is augmented by its support for EDO, SDRAM and FPM DRAM memory. SDRAM speed and synchronous operation have enabled the breakthrough in memory-systems design needed to meet the demands of fast high-performance processors.

SDRAM improves bandwidth to main memory because all address, data and control signals are synchronized with a system clock. With all operations in synch, system wait states are eliminated, thus providing increased performance over conventional DRAM.

Installing the Cyclone

Installation of the Cyclone system board depends on the type of case you use. The Cyclone is designed for the new NLX form factor and must be installed in an NLX chassis.

There are no tools required to install the Cyclone system board. The NLX chassis allows for the system board to slide into the computer rather than be screwed down.

NOTE: If you are unfamiliar with installing a system board, Micronics highly recommends that you read the computer user's manual or contact your dealer's technical support department.

Equipment Required

Micronics recommends using the following equipment with the Cyclone for a typical configuration:

- NLX chassis with standard hardware.
- A high-quality ATX power supply capable of providing continuous power within a 3 volt range. A power filter may be used with a noisy AC power source.
- Standard PS/2 style mouse and keyboard.
- Eight ohm speaker.
- Standard ribbon cables for internal connections.
- Standard power cord (grounded).

System Memory

System memory is necessary to operate the Cyclone system board. The Cyclone has two 3.3V unbuffered 64-bit, 168-pin DIMM sockets for a maximum of 384MB of memory. Support is provided for EDO, SDRAM and FPM DRAM memory. This section list the rules for adding memory to the Cyclone, give some examples of common memory configurations and show how to physically install the memory.



For long term reliability, Micronics recommends using DIMMs with gold-plated contacts. The use of tin-plated contacts may conflict with the gold alloy on the DIMM socket.

Adding Memory

The following is a list of rules to follow when installing DIMMs. If you follow these rules, your upgrade should be trouble-free:

- Use 10ns or faster SDRAM or 60ns or faster EDO DIMMs.
- DIMM memory modules support EDO and SDRAM (unbuffered) memory types.
- Singled-sided and double-sided memory modules are supported.
- Upgrade DIMMs one bank at a time. Start with Bank 0, then Bank 1 (one DIMM per bank).
- Different memory types and sizes in separate banks will cause the performance of the memory to run at the speed of the slowest RAM installed and/or cause operating system stability problems.

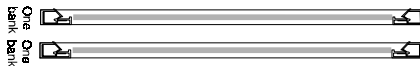

168-Pin DIMM

Memory Configurations

The following table lists the most common memory configurations. The memory available depends on the number of DIMMs installed.

Memory	DIMM 0	DIMM 1
16MB	2MBx64	
32MB	4MBx64	
32MB	2MBx64	2MBx64
48MB	2MBx64	4MBx64
64MB	8MBx64	
64MB	4MBx64	4MBx64
80MB	2MBx64	8MBx64
96MB	4MBx64	8MBx64
128MB	8MBx64	8MBx64
128MB	16MBx64	
256MB	16MBx64	16MBx64
384MB	16MBx64	32MBx64

Table 3-1: Memory Configurations

Installing DIMMs

To install the DIMMs, locate the memory banks on the system board and perform the following steps:

1. Hold the DIMM so that the notched edge is aligned with the notch on the DIMM socket (Figure 3-2).
2. Insert the DIMM at a 90 degree angle.
3. Gently push the DIMM straight down until it locks into place (past the release tabs).

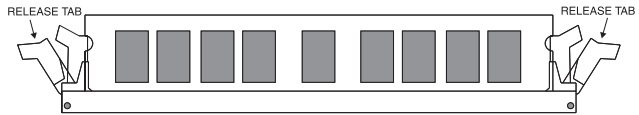

Figure 3-1: Installing a 168-Pin DIMM

Removing DIMMs

To remove DIMMs, follow the steps below:

1. With both thumbs (or fingers), press the release tabs away from the socket.
2. With the DIMM free from the release tabs, lift the module up and place in an antistatic bag or package.

Installing a CPU

The Cyclone is designed to support single Pentium processors. Follow the steps below to install the processor:

1. Turn off the computer and remove its cover.
2. Locate the ZIF socket illustrated in Figure 2-1.
3. Lift the lever of the socket.
4. Locate pin 1 on the processor and pin 1 on the socket (refer to Figure 2-1). Gently place the processor into the socket, making sure pin 1 on the processor and pin 1 on the socket are aligned.
5. Push the lever down until it locks into place.
6. Make sure the speed and the voltage selection jumpers are set correctly (refer to Chapter 2 - Jumper Settings).

WARNING: Pentium processors require a heat-sink with a cooling fan. Failure to provide adequate cooling of the processor may seriously affect system performance or cause permanent damage to the processor.

NOTE: The heatsink mounting spring can be directly mounted on the ZIF Socket 7.

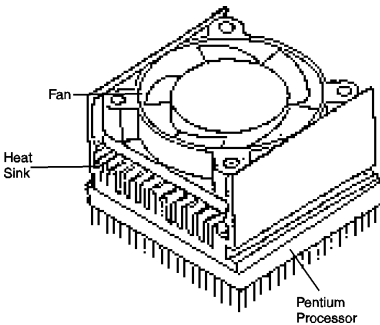

Installing a PCI Peripheral Card

Micronics PCI slots accommodate all PCI peripherals that meet the PCI 2.1 specifications. Follow the steps below to install a PCI card:

1. Turn the computer system off and remove its cover.
2. Choose an unused PCI slot and remove the slot cover.
3. Insert the card with the bottom edge level to the slot. *Never insert the card at an angle.*
4. Carefully push the card straight down, making sure the card is fully inserted.
5. Replace the screw which holds the card in place.
6. Replace the computer cover.
7. Refer to the PCI card's documentation additional instructions regarding installation and software drivers.

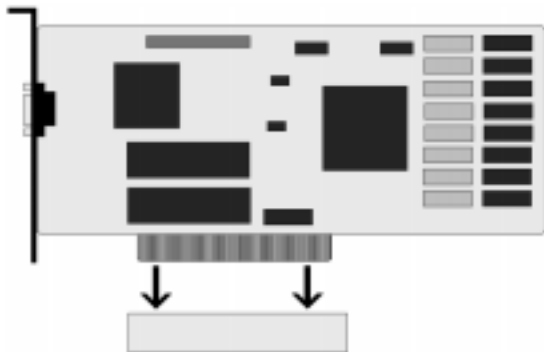

Figure 3-2: Installing a PCI Card

Installing an ISA Peripheral Card

Micronics ISA slots accommodate all standard ISA peripherals. Follow the steps below to install an ISA card:

1. Turn the computer system off and remove its cover.
2. Choose an unused ISA slot and remove the slot cover.
3. Insert the card with the bottom edge level to the slot. *Never insert the card at an angle.*
4. Carefully push the card straight down, making sure the card is inserted fully.
5. Replace the screw that holds the card in place.
6. Replace the computer cover.
7. Refer to the ISA card's documentation for additional instructions regarding installation and software drivers.

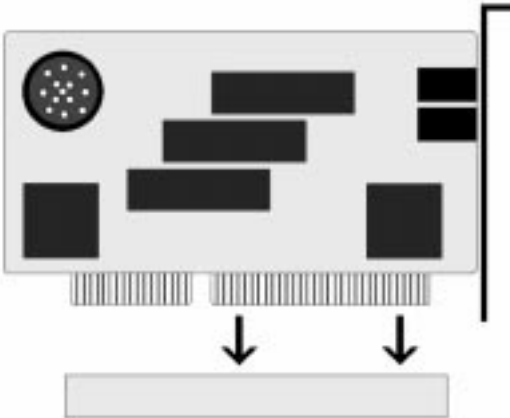

Figure 3-3: Installing an ISA Peripheral Card

Connecting the Graphics

The Cyclone comes with a VGA video connector. The 64-bit graphics processor supports up to 4MB of memory shared with the system. The graphics processor provides high-speed acceleration in all graphic modes and supports up to 1280x1024 resolution.

Connecting the Video Cable

1. Turn the computer system off.
2. Locate the monitor's power switch and make sure it is turned OFF.
3. If you have not already done so, plug the 15-pin connector end of your video cable into the video socket on the back of your monitor. Then tighten the two thumbscrews on the cable connector.
4. Plug the other end of the video cable into the video socket on the Cyclone and tighten the thumbscrews (see Figure 2.1).

See Chapter 5 for information on installing video device drivers.

Configuration

After the Cyclone system board and all hardware is installed, the system is ready for configuration. Before turning on the computer, make sure all cables are correctly connected and all jumpers are correctly set.

We recommend that you keep the computer cover off the first time you boot the system. This makes it faster and easier to correct any difficulties that might arise.

Initial Boot Up

Power up the Cyclone. If the system does not properly boot, check all your cables and peripherals for bad connections. You may also get beep codes or error messages. If this occurs, consult Appendix B for a guide to possible solutions.

After the system properly boots, it is ready to be configured. The following information explains the proper procedures for BIOS configuration.

Setup

The Setup program is used to configure the computer's BIOS (Basic Input/Output System). The computer's BIOS is responsible for configuring the system board and providing hardware information to the operating system. In order for the computer to run properly, run the Setup procedure after first installing the system board and whenever you make a hardware change to the system.

When the system is turned on, it performs a memory test, and a BIOS identification and system information screen is displayed on your monitor, as shown in Figure 4-1.

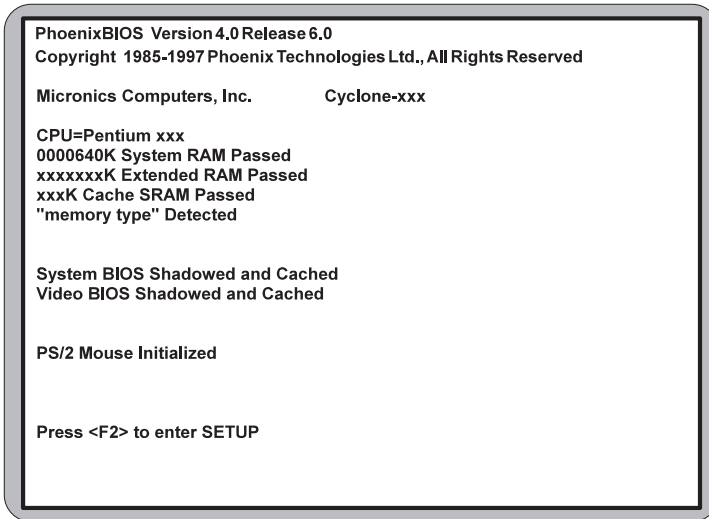

Figure 4-1: Power-Up Screen

When “Press <F2> to enter Setup” appears at the bottom of the screen, press the <F2> key to start the Setup program. The main CMOS Setup utility screen (Figure 4-2) appears. Note that the Setup program can only be activated during the boot sequence.

Running the Setup Procedure

The Cyclone system board has six primary CMOS configuration screens: Main Screen, Advanced Screen, Security Screen, Power Screen, Boot Screen and Exit Screen. To toggle between the screens, press the right arrow <→> and the left arrow <←> keys.

Setting the Main Screen

The CMOS Main screen is used to set the time and date, to set the floppy drive types, to configure IDE hard disks and to configure the video. This chapter explains how to configure each of these categories. To move between the categories, use the up and down arrow <↑/↓> keys.

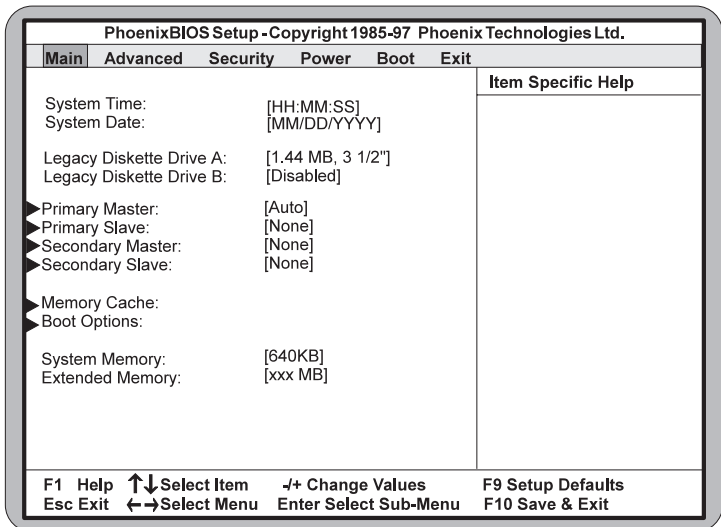

Figure 4-2: CMOS Main Screen

System Time and Date

To set the Time, use the <-> key to decrease the number and the <+> key to increase the number. To move the prompt forward, use the <Tab> key; to move the prompt backward, use the <Shift-Tab> key. To set the Date, use the up and down arrows <↑/↓> to highlight the System Date and follow the same procedure used to set the Time.

Legacy Diskette A or B

To configure a floppy drive added to or removed from your computer, use the up and down arrow keys <↑/↓> to select the desired drive. Use the <+/-> keys to change the setting until it matches the floppy drive you installed. The BIOS supports 2.88MB, 1.44/1.25MB, 1.2MB, 720KB, and 360KB floppy drives.

NOTE: The 1.25MB, 3 1/2" option references a 1024 byte/sector Japanese media format. Support for this format requires a 3 1/2" 3-Mode floppy disk drive.

Primary and Secondary IDE Devices

If you are setting up a SCSI hard disk, select None in the IDE Device parameters (see your SCSI card manual for more details). To install an IDE device, select the device to configure and press ENTER. An IDE Device submenu will appear (see Figure 4-3).

Memory Cache

This selection allows you to enable the external memory cache. For optimal performance, select Enabled (default).

Boot Options

This selection controls the system bootup options. Press the ENTER key to enter the Boot Options submenu. You can set the power-on state for the Numlock feature. Setting Numlock to Auto (default) activates Numlock if the BIOS detects a numeric keyboard. Setting the Floppy Check selection for Enabled (default) will check for the floppy disk type on bootup.

System Memory

The System Memory category identifies the size of the base memory. It cannot be changed.

Extended Memory

The Extended Memory category automatically detects the amount of memory installed above the amount in the System Memory category. Because the BIOS automatically calculates the amount of memory installed in your system, you cannot change this category without adding or removing memory.

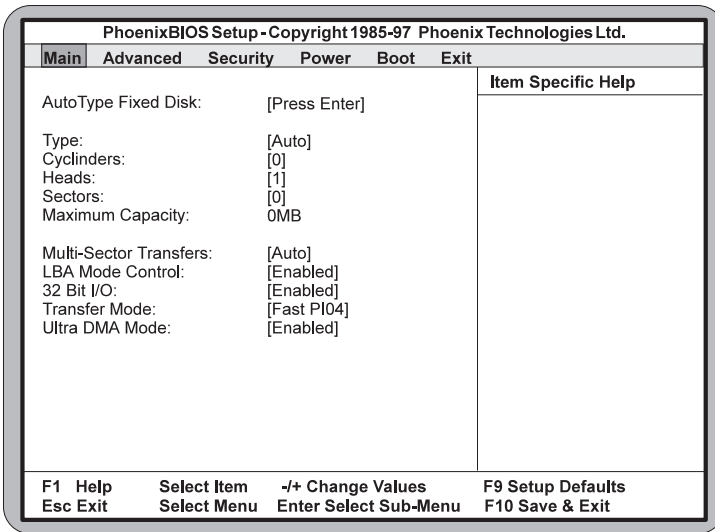

Figure 4-3: IDE Device Submenu

AutoType Fixed Disk

Press ENTER to detect the drive type for drives that comply with ANSI specifications.

Type

This category selects the drive type installed in the system. The options are Auto (default), User and None. If Autotype Fixed Disk does not find your drive's parameters, fill this information in manually under the User category. This information may be in the manual which came with your system. If not, contact your dealer or the hard drive manufacturer to fill in this category. If you are using a SCSI hard drive, select None and refer to the documentation which came with the SCSI adapter.

Multiple-Sector Transfers

This category determines the number of sectors per block for multiple sector transfers. The options are Auto (default), Disabled, 2 Sectors, 4 Sectors, 6 Sectors, 8 Sectors and 16 Sectors.

LBA Mode Control

Enabling this selection causes LBA (Logical Block Addressing) to be used in place of Cylinders, Heads and Sectors. The default setting is Enabled.

32-Bit I/O

This category allows you to enable the 32-bit I/O function of the PCI IDE controller. Select Disabled if your drive will not run at this speed. The default setting is Enabled.

Transfer Mode

This category sets the transfer speeds for IDE devices. The options are: Standard, Fast PIO 1, Fast PIO 2, Fast PIO 3 and Fast PIO 4 (default). The Fast PIO options are for higher speed devices, with Fast PIO 4 being the fastest mode.

Ultra DMA Mode

This option will enable or disable the Ultra DMA/33 feature. Ultra DMA/33 is a hard drive interface protocol that increases the burst data transfer rate to 33MBytes per second.

Setting the Advanced Screen

To move to the Advanced screen, use the left and right arrow keys <←/→> keys until you see the screen below.

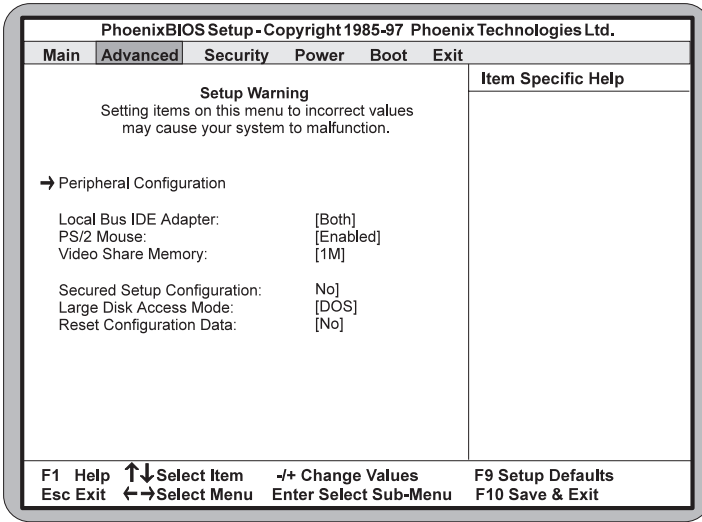

Figure 4-4: Advanced Screen

Peripheral Configuration

To configure an I/O device, press ENTER. The Peripheral Configuration submenu appears (see Figure 4-5).

Local Bus IDE Adapter

Enables or disables the integrated Local Bus IDE adapter. The IDE controller may be set for Primary, Both (default) or Disabled.

PS/2 Mouse

When disabled, this selection prevents the PS/2 mouse from functioning and frees up IRQ12. Selecting Enabled

(default) allows the operating system to determine whether to enable or disable the mouse.

Video Share Memory

Sets the amount of memory to assign for video memory. The default is 1MB.

Secured Setup Configuration

Select Yes if you want the system settings to be secured from change by a Plug and Play operating system. The default setting is No.

Large Disk Access Mode

If you are using a Microsoft operating system (MS-DOS, Windows or NT) or any other form of DOS (Novell DOS or PC-DOS), set to DOS (default). If you are using other operating systems such as OS/2 or Unix, set to OTHER.

Reset Configuration Data

Select Yes to reset Extended System Configuration Data (ESCD) when you exit Setup. This selection allows the PnP BIOS to detect your PCI and ISA PnP devices and reallocate resources to them. The default setting is No.

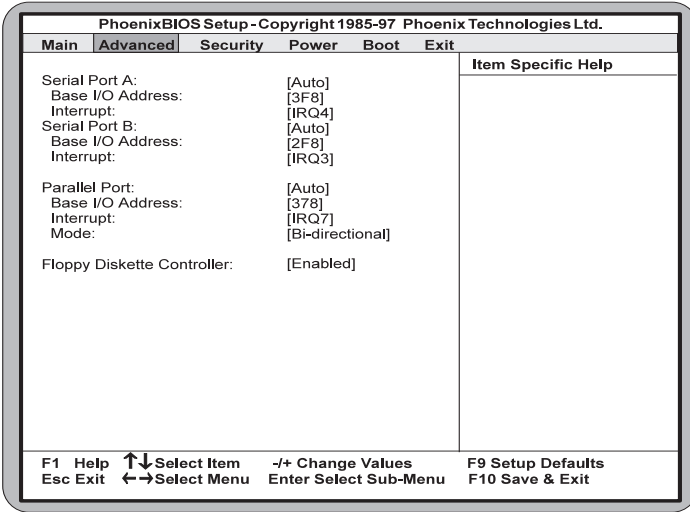

Figure 4-5: Advanced Screen Submenu

Serial Port A and Serial Port B

Serial Port A and B may be configured using the following options: Disabled (No configuration), Enabled (User configuration), Auto (BIOS configuration) and PnP O/S (O/S configuration).

Parallel Port

The parallel port may be configured using the following options: Disabled (No configuration), Enabled (User configuration), Auto (BIOS configuration) and PnP O/S (O/S configuration).

Floppy Disk Controller

The selection allows you to enable or disable the floppy disk controller. The default is Enabled.

Security Screen

The Security screen controls access to the computer. The security screen allows for settings of two passwords. The Supervisor Password allows access to the system and Setup. The User Password allows access to the system, but not to all Setup features.

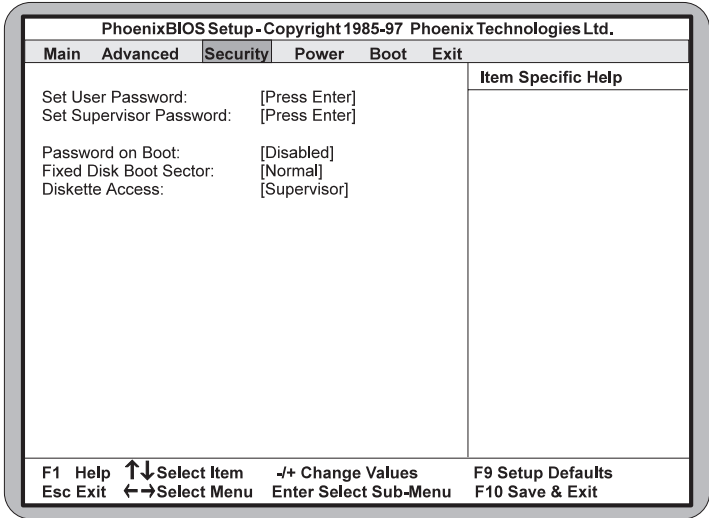

Figure 4-6: Security Setup Screen

Set User Password

This selection controls access to the Setup utility. Press the ENTER key to enter the User Password submenu. The screen on the following page appears.

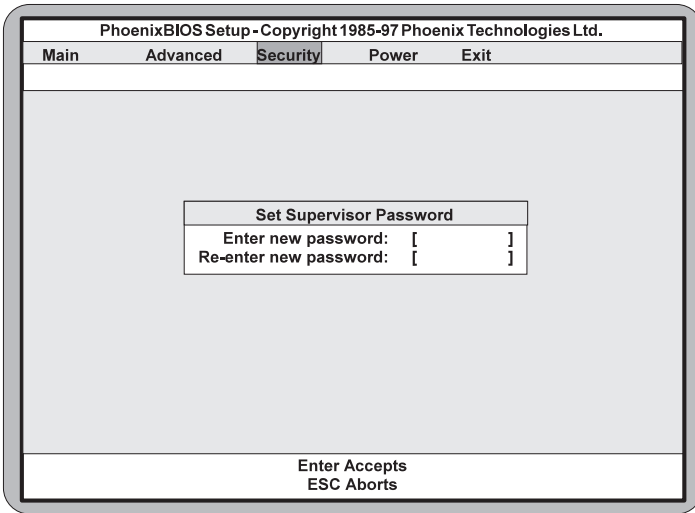

Figure 4-7: Supervisor Password Submenu

Type the password and press the ENTER key. Retype the password and press the ENTER key again. Write down the password somewhere safe so it will not be forgotten. The password may be disabled by setting the new password to nothing (pressing the ENTER key without first typing a password).

NOTE: After a password is entered, it is saved immediately. All other changes may still be discarded (see Exit Screen).

Set Supervisor Password

This selection controls access to the Setup utility. Follow the same procedure used to set the User Password.

WARNING: If you forget the Supervisor Password, it cannot be disabled without discharging the CMOS.

Password on Boot

When enabled, the system requires a password upon power up. Either the Supervisor or User Password may be entered. The default setting is Disabled.

Fixed Disk Boot Sector

This selection allows the boot sector of the fixed disk to be write protected. The default setting is Normal. When set for Write Protected, it serves as a form of virus protection. If the passwords are enabled, this option may only be changed by the Supervisor.

Diskette Access

This selection allows floppy disk access with an option of the supervisor or user. Selecting Supervisor (default) gives floppy disk access to the supervisor only. Selecting User gives floppy disk access to both the user *and* the supervisor. If the passwords are enabled, this option may only be changed by the Supervisor.

Power Screen

The Power Screen controls the power management functions of the system. To move to the Power Screen, use the left and right arrow <←/→> keys until it appears. To move between the categories, use the up and down arrow keys <↑/↓>.

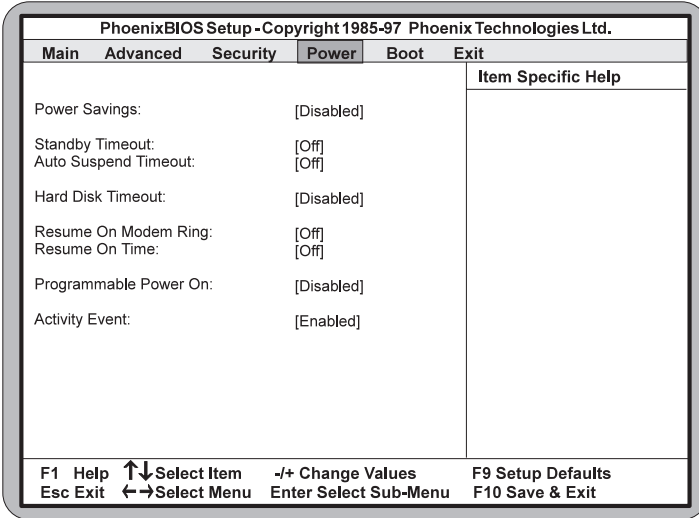

Figure 4-8: Power Screen

Power Savings

This selection allows you to change the system power management settings. Maximum Power Savings conserves the greatest amount of system power. Maximum Performance conserves power but allows greatest system performance. To alter these settings, choose Customize. To turn off power management, choose Disabled (default).

Standby Time-out

The Standby Time-out selection sets the amount of time that elapses for the system to enter Standby Mode. Standby Mode turns off various devices in the system, including the display screen, until you start using the system again. The options are Off (default), 1 min., 2 min., 4 min., 6 min., 8 min., 12 min. or 16 min.

Auto Suspend Time-out

The Standby Time-out selection sets the amount of time that elapses for the system to enter Suspend Mode. The options are Off (default), 5 min., 10 min., 15 min., 20 min., 30 min., 40 min. or 60 min. Before making changes, "Customized" must be selected in the Power Management Mode selection.

Hard Disk Time-out

This selection sets the amount of time that elapse before the hard disk enters spin-down mode to conserve power. Before making changes, "Customized" must be selected in the Power Management Mode selection. The options are Disabled (default), 10 sec., 15 sec., 30 sec., 45 sec., 1 min., 2 min., 4 min., 6 min., 8 min., 10 min. and 15 min.

Resume On Modem Ring

When this feature is turned On, the system will wake up from Suspend mode when an incoming call is detected on your modem. Before making changes, "Customized" must be selected in the Power Management Mode category. The default setting is Off. NOTE: This option does not require a special modem.

Resume On Time

When this feature is turned On, the system counts down to zero and awakes from Standby or Suspend mode. Before making changes, "Customized" must be selected in the Power Management Mode category. The default setting is Off.

Programmable Power On

When this selection is enabled, you can set the date and time for the system to wake up. The default setting is Disabled. Before making changes, "Customized" must be selected in the Power Management Mode selection.

Activity Event

Selecting this option opens the submenu to configure IRQ's for an Activity Event. Selecting an IRQ causes the system to wake up from a power savings mode if any activity occurs at that IRQ.

Boot Screen

The Boot screen allows you to configure the power up system configuration settings. To move to the Boot Screen, use the left and right arrow <←/→> keys until it appears. To move between the categories, use the up and down arrow keys <↑/↓>.

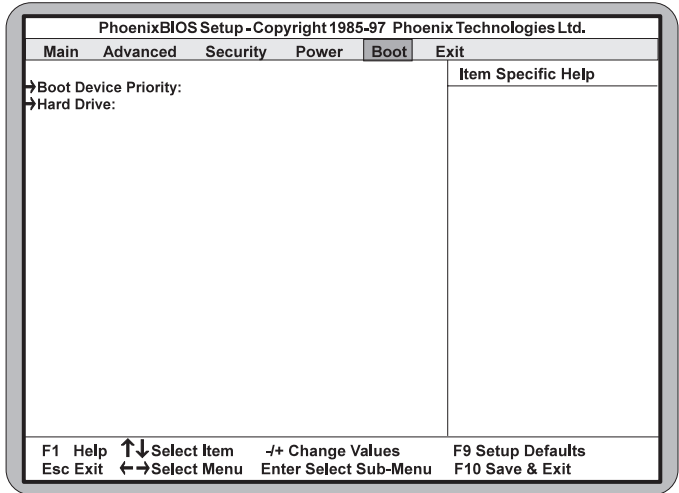

Figure 4-8: Boot Screen

Boot Device Priority

This selection allows you to configure the boot order for the diskette drive (default), hard drive or CD-ROM.

Hard Drive

This selection lists the available bootable devices.

Exit Screen

After you complete configuring the BIOS, select the Exit screen. To move to the Exit Screen, use the left and right arrow <←/→> keys until it appears. To move between the categories, use the up and down arrow keys <↑/↓>.

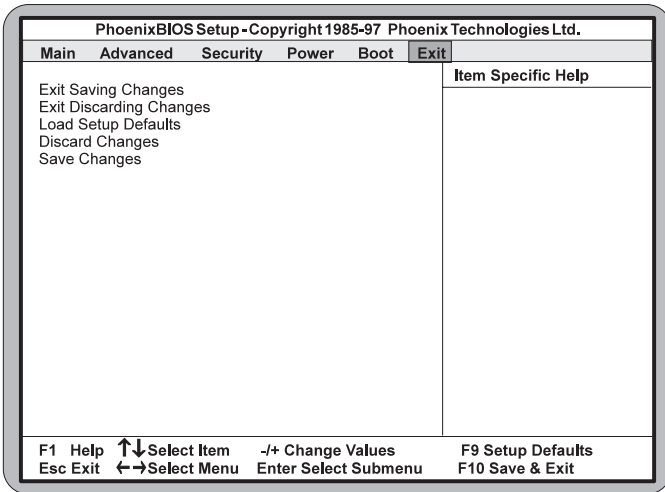

Figure 4-10: Exit Screen

Choose “Save Changes and Exit” and reboot the computer. Your computer is ready for use.

Installing Device Drivers

This chapter explains how to install the software device drivers and utilities necessary to utilize the graphics support. Other drivers and utilities are available through our online services.

About Device Drivers

Device drivers are necessary for the computer system to communicate with devices such as CD-ROM drives, sound controllers, graphics adapters or devices that are not natively supported by the system BIOS. Once started, device drivers remain active in the background of the computer system. Usually a device driver is added to the CONFIG.SYS file, the AUTOEXEC.BAT file or both.

Installing the Graphics Drivers

Windows 95

1. Start Microsoft Windows 95. The New Hardware Found screen appears.
2. Insert the Cyclone Drivers and Utilities CD into your CD-ROM drive.
3. From the New Hardware Found screen, select the Driver From Disk Provided by Hardware Manufacturer option. Click on Next.
4. Type in the driver location: D:\ (where D is the CD-ROM drive letter). Click on OK.
5. Windows 95 copies the Cyclone video drivers and utilities to your hard drive.

Appendix

Specifications

A

Part Number:	09-00321-XX
Processor:	Single ZIF Socket 7 Intel Pentium® chip - 75-200MHz Intel Pentium® chip w/ MMX 166/233MHz AMD-K5™ PR75 to PR166 AMD-K6™ 166 to 233MHz Switching Regulator Integrated VRM
CPU Clock Select:	Frequency synthesizer chip Support for 50, 60, 66 & 75MHz CPU bus
Chipset:	SIS 5597 SMC FDC37C669x Ultra I/O chip
Form Factor:	NLX form factor (9"x10") Four layer board
Expansion:	Two 32-bit PCI slots Two 16-bit ISA slots (One is a shared PCI/ISA slot) Riser Card
BIOS:	Phoenix 4.06 BIOS on 2MB Flash PCI auto configuration Plug and Play ready Auto detection of memory size Auto detection of EDO and SDRAM memory. Auto detection of IDE hard disk types Soft Power Down Wake-On-Ring DMI 2/0 / SMI Multi-boot II

Appendix A: Technical Information

Memory Capacity:	Maximum memory - 384MB Two unbuffered 64/72 bit, 168-pin DIMM sockets Supports EDO and SDRAM memory
Keyboard/Mouse:	PS/2 style keyboard and mouse connectors
External Cache:	256K Pipeline Burst SRAM 512K Pipeline Burst SRAM (optional)
Graphics:	SIS 5597 chipset 1MB to 4MB using system memory Maximum Resolution: 1280x1024x256
I/O Ports:	Two high speed serial ports (16550 compatible) One 25-pin Parallel Port with ECP and EPP Two USB connectors
Floppy Port:	Supports 720K - 2.88MB formats Auto detection of add-in floppy controllers
PCI IDE Ports:	Ultra DMA/33 IDE Mode 4 Enhanced IDE w/ Bus Mastering Two 40-pin IDE connectors (Primary and Secondary IDE). Multiple sector transfer support Auto detection of add-in IDE board

Environmental Specifications

The environment in which the Cyclone is located is critical. Micronics recommends the following environmental specifications:

Temperature Range

Operating: 50 to 104 degrees Fahrenheit (10 to 40 degrees Celsius).

Non -Operating: 50 to 140 degrees Fahrenheit (10 to 60 degrees Celsius).

Shipping: -22 to 140 degrees Fahrenheit (-30 to 60 degrees Celsius).

Relative Humidity

Operating: 20% to 80%.

Non-Operating: 5% to 90%.

Battery Disposal

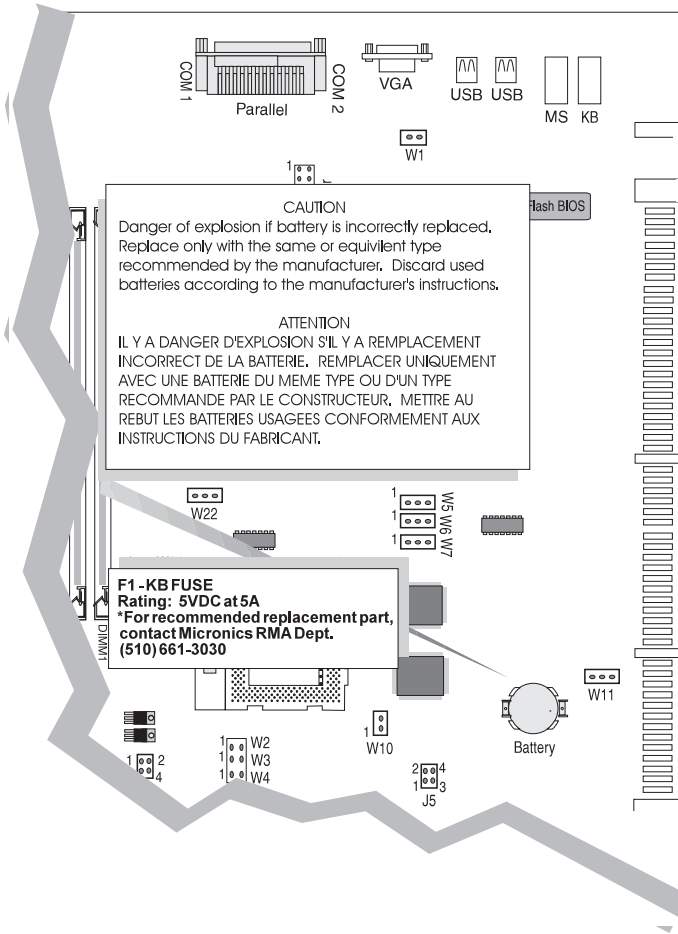

WARNING:

Please do not open battery, dispose of in fire, recharge, put in backwards or mix with used or other battery types. The battery may explode or leak and cause personal injury.

Support and Information Services

Micronics offers a variety of support and information services to help you get the most from your product. The following services are available:

- ▲ Technical Support
- ▲ Electronic Bulletin Board Service (BBS)
- ▲ Return Materials Authorization (RMA)
- ▲ Fax-On-Demand
- ▲ World Wide Web
- ▲ Customer Service

Refer to Table A-1 for details on these services.

Technical Support

If you need technical assistance, our Technical Support Engineers will be glad to help you. You can contact us via telephone, fax or BBS. Before calling Technical Support please have the following information ready:

- ❑ The model name and 09 part number of your Micronics product, which is silk screened on the face of the Cyclone system board.
- ❑ Your computer information such as CPU type, operating system, amount of installed memory and other peripherals installed in your computer.
- ❑ Try to call from the location of your computer.

NOTE: For Return Material Authorization purposes, please keep a copy of your product receipt.

Appendix A: Technical Information

Service	Hours	Country	Telephone Number
Technical Support - Live phone help from Technical Support Engineers	M-F: 7:00am to 5:00pm (PST)	USA France UK	(510) 661-3000 (510) 651-6982 (Fax) +33 (1) 45 43 56 26 +33 (1) 45 43 17 78 (Fax) +44 (1256) 844899 +44 (1256) 364222 (Fax)
Electronic Bulletin Board Service (BBS) - Information on software upgrades, new releases and other helpful information	24 hours a day 7 days a week "	USA UK	(510) 651-6837 14400 baud rate, Parity=N, Data Bits=8, Stop Bits=1 YMODEM and ZMODEM (recommended file transfer protocols) +44 (1256) 363373
RMA (Return Materials Authorization) - Return products for repair	M-F: 8:00am to 4:45pm (PST)	USA	(510) 661-3030 (510) 683-0543 (Fax)
Fax-On-Demand - Automated system for product literature, technical bulletins and other helpful information	24 hours a day 7 days a week	USA	(510) 661-3199
World Wide Web - Product information, technical support, press releases and other helpful information	24 hours a day 7 days a week "	USA Europe	http://www.micronics.com http://www.mcrni.com
Customer Service - Order Micronics and Orchid products	M-F: 8:00am to 5:00pm (PST)	USA France UK Taiwan	(800) 577-0977 (510) 651-3666 (Fax) +33 (1) 45 43 56 26 +33 (1) 45 43 17 78 (Fax) +44 (1256) 479 898 +44 (1256) 364222 (Fax) +886 2 918 5005 +886 2 911 5472 (Fax)

Table A-1: Support and Information Services

Appendix

POST Messages**B**

The following table lists the Power On Self Test (POST) messages, possible causes and solutions.

Message	Possible Cause	Solution
DISKETTE DRIVE A FAILURE	Drive A failed or is missing.	Check Setup and cable connections.
DISKETTE DRIVE B FAILURE	Drive B failed or is missing.	Check Setup and cable connections.
EXTENDED RAM FAILED AT OFFSET: nnnn	Extended memory not working or configured properly.	Replace defective memory.
FAILING BITS: nnnn	Memory failure in System, Extended, or Shadow memory.	Replace defective memory.
FIXED DISK X FAILURE (where X =0 or 1)	The hard disk is not configured or working properly.	Rerun SETUP and check connections, or replace hard disk.
FIXED DISK CONTROLLER FAILURE	The controller card has failed.	Check configuration and connections, or replace controller card.
INCORRECT DRIVE A TYPE	Floppy drive A: not set correctly in Setup.	Run Setup.
INCORRECT DRIVE B TYPE	Floppy drive A: not set correctly in Setup.	Run Setup.
INVALID NVRAM MEDIA TYPE	NVRAM chip is bad.	Requires repair of system board.
KEYBOARD ERROR, or KEYBOARD CONTROLLER ERROR	The keyboard or keyboard controller failed.	Check connections. You may have to replace the keyboard or controller.
KEYBOARD ERROR nn	A key is jammed or was held down during boot.	Make sure the keys are not jammed or dirty.
KEYBOARD LOCKED	Keyswitch on the front of the case is locked.	Unlock the keyswitch.

Message	Possible Cause	Solution
MONITOR TYPE DOES NOT MATCH CMOS	Monitor type not correctly identified in Setup.	Run Setup and enter correct monitor type.
OPERATING SYSTEM NOT FOUND	Operating system cannot be located on Drive C: or Drive A:	Check Setup to see if Drive A: and C: are properly configured, or put a bootable disk in Drive A:
PARITY CHECK 1 nnnn	Parity error found in the system bus.	Check Setup. Board repair may be required.
PARITY CHECK 2 nnnn	Parity error found in the I/O bus.	Check Setup. Board repair may be required.
PREVIOUS BOOT INCOMPLETE - DEFAULT CONFIGURATION USED	Previous POST did not complete successfully.	Run Setup, load default BIOS settings, make any necessary adjustments, and save the changes
REAL TIME CLOCK ERROR	Real-time clock failed BIOS test.	May require battery replacement or board repair.
SHADOW RAM FAILED AT OFFSET	Shadow RAM failed.	May require repair of system board.
SYSTEM BATTERY IS DEAD	System battery died.	Replace the system battery and run Setup to reconfigure the system.
SYSTEM CACHE ERROR - CACHE DISABLED	External (L2) cache failed BIOS test.	System will still run, but slower. Replace cache at convenience.
SYSTEM CMOS CHECKSUM BAD - RUN SETUP	System CMOS has been corrupted or modified incorrectly.	Run Setup and reconfigure the system.
SYSTEM RAM FAILED AT OFFSET: nnnn	System RAM failed.	Replace defective RAM.
SYSTEM TIMER ERROR	Timer test failed.	Requires repair of system board.

Beep and POST Codes

C

Beep codes are a series of beeps sent through the speaker which indicate a problem during the Power On Self Test (POST). If text appears on the video screen, the Cyclone has completed POST; any other tone from the speaker indicates something other than a POST error. These tones *are not* described in the tables on the following pages.

The beep error codes are a series of beeps. The duration of the beep tones are constant, but the length of the pauses between the beeps varies. For example: a 1-3-3 beep code will sound like one beep, a pause; three beeps consecutively, another pause and then three more beeps.

One beep code is often misunderstood. If a video card is not installed or is failing, the system board will generate a long-short-long-short beep code. This is often interpreted as a 1-2-1 beep code. But POST errors always vary in the length of the pause and not the duration of the beep tone.

Another way of identifying a POST error is to use a device called a POST card. This peripheral card is inserted into one of the ISA slots and has an LED (or LCD) read out showing the contents of port 80h.

The following tables list all beep codes and POST routines.

Appendix C: Beep and POST Codes

Code	Beeps	POST Routine Description
02		Verify Real Mode.
04		Get CPU type.
06		Initialize system hardware.
08		Initialize chipset registers with initial POST values.
09		Get in POST Reg.
0A		Initialize CPU registers.
0C		Initialize cache initial POST values.
0E		Initialize I/O.
0F		Initialize the localbus IDE.
10		Initialize Power Management.
11		Load alternate registers with initial POST values.
12		Jump to UserPatch0.
14		Initialize keyboard controller.
16	2-2-3	BIOS ROM checksum.
18		8254 timer initialization.
1A		8237 DMA controller initialization.
1C		Reset Programmable Interrupt Controller.
20	3-1-1	Test DRAM refresh.
22	3-1-3	Test 8742 Keyboard Controller.
24		Set ES segment register to 4 GB.
28		Autosize DRAM.
2A		Clear 512K base RAM.
2C	3-4-1	Test 512K base address lines.
2E	3-4-3	Test 512K base memory.
32		Test CPU bus-clock frequency.
34		Test CMOS RAM.
35		Initialize alternate chipset registers.
37		Reinitialize the chipset (MB only).
38		Shadow system BIOS ROM.
39		Reinitialize the cache (MB only).
3A		Autosize cache.
3C		Configure advanced chipset registers.
3D		Load alternate registers with CMOS values.
40		Set initial CPU speed.
42		Initialize interrupt vectors.
44		Initialize BIOS interrupts.
46	2-1-2-3	Check ROM copyright notice.
47		Initialize manager for PCI Option ROMs.
48		Check video configuration against CMOS.
49		Initialize PCI bus and devices.

Code	Beeps	POST Routine Description
4A		Initialize all video adapters in system.
4C		Shadow video BIOS ROM.
4E		Display copyright notice.
50		Display CPU type and speed.
51		Initialize EISA board.
52		Test keyboard.
54		Set key click if enabled.
56		Enable keyboard.
58	2-2-3-1	Test for unexpected interrupts.
5A		Display prompt "Press F2 to enter SETUP".
5C		Test RAM between 512 and 640k.
60		Test extended memory.
62		Test extended memory address lines.
64		Jump to UserPatch1.
66		Configure advanced cache registers.
68		Enable external and CPU caches.
6A		Display external cache size.
6C		Display shadow message.
6E		Display non-disposable segments.
70		Display error messages.
72		Check for configuration errors.
74		Test real-time clock.
76		Check for keyboard errors.
7C		Set up hardware interrupt vectors.
7E		Test coprocessor if present.
80		Disable onboard I/O ports.
82		Detect and install external RS232 ports.
84		Detect and install external parallel ports.
86		Re-initialize on-board I/O ports.
88		Initialize BIOSData Area.
8A		Initialize Extended BIOS Data Area.
8C		Initialize floppy controller.
90		Initialize hard-disk controller.
91		Initialize localbus hard-disk controller.
92		Jump to UserPatch2.
93		Build MPTABLE for multi-processor boards.
94		Disable A20 address line.
96		Clear huge ES segment register.
98		Search for option ROMs.
9A		Shadow option ROMs.

Appendix C: Beep and POST Codes

Code	Beeps	POST Routine Description
9C		Set up Power Management.
9E		Enable hardware interrupts.
A0		Set time of day.
A2		Check key lock.
A4		Initialize typematic rate.
A8		Erase F2 prompt.
AA		Scan for F2 keystroke.
AC		Enter SETUP.
AE		Clear in-POST flag.
B0		Check for errors.
B2		POST done - prepare to boot operating system.
B4		One beep.
B6		Check password (optional).
B8		Clear global descriptor table.
BC		Clear parity checkers.
BE		Clear screen (optional).
BF		Check virus and backup reminders.
C0		Try to boot with INT 19.
D0		Interrupt handler error.
D2		Unknown interrupt error.
D4		Pending Interrupt.
D6		Initialize option ROM error.
D8		Shutdown error.
DA		Extended Block Move.
DC		Shutdown 10 error.
		The following are for boot block in Flash ROM:
E2		Initialize the chipset.
E3		Initialize refresh counter.
E4		Check for Forced Flash.
E5		Check HW status of ROM.
E6		BIOS ROM is OK.
E7		Do a complete RAM test.
E8		Do OEM initialization.
E9		Initialize interrupt controller.
EA		Read in the bootstrap code.
EB		Initialize all vectors.
EC		Boot the Flash program.
ED		Initialize the boot device.
EE		Boot code was read OK.

Appendix

Hard Disk Drive Types**D**

The following table lists the IDE hard disk types supported by the Cyclone.

Type	Cylinders	Heads	Write Precomp	Sectors	Size
1	306	4	128	17	10
2	615	4	300	17	21
3	615	6	300	17	32
4	940	8	512	17	65
5	940	6	512	17	99
6	615	4	none	17	21
7	462	8	256	17	32
8	733	5	none	17	31
9	900	15	none	17	117
10	820	3	none	17	21
11	855	5	none	17	37
12	855	7	none	17	52
13	306	8	128	17	21
14	733	7	none	17	44
15	N/A	N/A	N/A	N/A	N/A
16	612	4	0	17	21
17	977	5	300	17	42
18	977	7	none	17	59
19	1024	7	512	17	62
20	733	5	300	17	31
21	733	7	300	17	94
22	733	5	300	17	31
23	306	4	0	17	10
24	612	4	305	17	21
25	612	2	300	17	10
26	614	4	none	17	21
27	820	6	none	17	42
28	977	5	none	17	42
29	1218	15	none	36	336
30	1224	15	none	17	159

Appendix D: Hard Disk Drive Types

Type	Cylinders	Heads	Write Precomp	Sectors	Size
31	823	10	512	17	71
32	809	6	128	17	42
33	830	7	none	17	50
34	830	10	none	17	72
35	1024	5	none	17	44
36	1024	8	none	17	71
37	615	8	128	17	42
38	1024	8	none	26	109
39	925	9	none	17	72

Appendix

Updating the System BIOS

E

The Micronics system boards are designed so that the BIOS can be reprogrammed using a BIOS file. You can easily FLASH a BIOS by following the steps below:

1. After downloading the appropriate BIOS file from our BBS or Website, extract it to a bootable DOS diskette.
2. Reboot your system with the DOS diskette in the A: drive. To make sure a clean DOS environment is loaded, press the F5 key while "Starting MS-DOS" is displayed. After the system has rebooted, the cursor will appear at the A:> prompt.
3. Now you can run the FLASH utility from the bootable floppy disk. Refer to the README.TXT file included with the BIOS update for detailed instructions.
4. After the update process has completed and the system reboots, verify that the new BIOS version appears on-screen. If you have problems during this process, or if you have questions about the procedure, please call Technical Support.



If you encounter any problems during this process, or if you have questions about the procedure, please call Technical Support.

NOTE: If you prefer to send your system board in for the upgrade, the RMA department offers this service free of charge if your system board is under warranty.

Appendix **Limited Warranty**

F

Except as described below, Micronics warrants the products to be free from defects in material and workmanship in normal use for a period of one (1) year from date of purchase. Should any product fail to perform according to this warranty at any time during the warranty period, except as provided below, Micronics or its authorized service centers will, at Micronics' option, repair or replace the product at no additional charge.

The warranty does not cover loss or damage which occurs in shipment or which is due to: (1) improper installation or maintenance, misuse, neglect or any cause other than ordinary commercial application, including without limitation, accidents or acts of God; (2) adjustment, repair, or modification by other than a Micronics authorized service center; (3) improper environment, excessive or inadequate heating or air conditioning, or electrical power failures, surges or other irregularities; (4) any statement about the product other than those set forth in this warranty; or (5) nonconformity to models or samples shown to the purchaser. Any models or samples were for the sole purpose of suggesting the character of the product and are not intended to form the basis of the bargain.

A receipt or copy of the invoice with the date of purchase from a Micronics reseller is required before any warranty service can be rendered. Service can be obtained by calling Micronics for a Return Merchandise Authorization (RMA) Number.

The RMA Number should be prominently displayed on the outside of the shipping carton of the returned product. Returned product should be shipped prepaid or hand carried to Micronics. The purchaser assumes risk of loss or damage in transit, and unless otherwise agreed to in writing by Micronics, will pay inbound shipping charges.

The exclusive remedy of the purchaser under this warranty above will be repair or replace at Micronics' option,

but if for any reason that remedy should fail of its essential purpose, the exclusive remedy of the purchaser shall then be actual damages up to amounts paid for the defective product by the purchaser. This limited warranty shall be deemed to “fail of its essential purpose” if, after repeated efforts, Micronics is unable to make the product operate as warranted. Micronics’ liability for damages to the purchaser for any cause whatsoever; regardless of the form of action and whether in contract or in tort, shall be limited to the purchase price in effect when the cause of action arose for the product that is the basis of the claim.

Micronics will not be liable for any lost profits or any indirect, special incidental or consequential damages in connection with the product, even if Micronics has been advised of the possibility of such damages.

Micronics makes no warranties or representations as to performance of products or as to service to distributor or to any person, except as set forth in Micronics; limited warranty accompanying delivery of product.

Micronics disclaims all other warranties whether oral, written, expressed, or implied, including without limitation, the warranties of design, merchantability, or fitness for a particular purpose, if applicable, or arising from a course of dealing, usage or trade practice.

Non-Warranty Service

After the one year warranty service is no longer in effect, repair service is still available for Micronics products. For more information, contact Micronics’ RMA department at (510) 661-3030. The RMA department is open between 8:30 A.M. and 4:45P.M. Pacific Standard Time.

FCC Statement

This equipment has been tested and found to comply within the limits for a Class B digital device, pursuant to Part 15 of the FCC Rules. These limits are designed to provide reasonable protection against harmful interference in a residential installation. This equipment generates, uses and can radiate radio frequency energy and, if not used in accordance with the instructions, may cause harmful interference to radio communications. Interference to radio or television reception can be determined by turning the equipment off and on. You are encouraged to try to correct the interference by one or more of the following measures:

- ▲ Reorient the receiving antenna.
- ▲ Increase the separation between the equipment and the receiver.
- ▲ Connect the equipment into an outlet on a circuit different from that to which the receiver is connected.
- ▲ Consult your dealer or an experienced radio/TV technician for help.

To meet FCC requirements, shielded cables are required.

NOTE: Changes or modifications not expressly approved by Micronics could void your authority to operate the equipment.

Glossary

16550 UART - A high speed chip for controlling serial ports. Although unnecessary for a mouse, it is required for modems that are 14,400 baud or faster.

APM - An acronym for Advanced Power Management. The APM specification defines a layer of software that supports power management in computers with power manageable hardware.

Asynchronous - Operations that do not require the clocks of communicating devices to be coordinated. See Synchronous.

ATX - A system board size measuring approximately 12" x 9.6".

Bidirectional Parallel Port - A type of parallel port that can send and receive information.

BIOS - An Acronym for Basic Input/Output System. Configures the system board and provides hardware information to the operating system.

Bit - A contraction of Binary digit. The smallest unit of information in a binary number system. A bit represents a choice between either zero or one.

Boot - To start up the computer and load the operating system software. See cold boot and warm boot.

Buffered DIMMs - The 168-pin buffered DIMM modules use buffer logic chips on their control lines to reduce loading on the system board. This buff-

ering action increases the maximum number of modules on the same system board. The buffered DIMMs come with standard DRAM chips for either 5V or 3.3V operation.

Bus - A group of electronic paths used to send data between parts of the system. On a system board, the bus connects the peripheral cards with the microprocessor via the expansion slots.

Bus Mastering - The ability of a peripheral card to control the bus without requiring intervention of the CPU.

Byte - A group of adjacent bits treated as a unit. Eight bits are typically considered one byte. Also called a character.

Cache - A process where information is copied from the slower memory (DRAM) to the faster memory (SRAM). Information that is likely to be read or edited is stored in the cache providing significant performance increases.

Cache Hit - The percentage of request for data from memory that can be served from the cache.

Cache Miss - A memory access which cannot be supplied from cache.

Cold Boot - Starting the computer by turning on the power or pressing the RESET button. A cold boot makes the processor execute all of the diagnostics. See boot and warm boot.

CPU - An acronym for Central Processing Unit. A CPU performs arithmetic calculations, makes logical decisions, and directs the operation of the computer in conjunction with the operating system.

DIMM - An acronym for Dual Inline Memory Module. A small printed circuit board containing memory chips.

Disk Drive - A hardware device which provides for the storage of data on diskettes or hard metal disks that have a magnetic coating. A disk drive functions by spinning at high speed while moving a device called the read/write head across the disk's surface in order to read or write data in magnetic code.

DMI - An acronym for Desktop Management Interface. DMI makes hardware inventory easier. It defines a format of a management agent for desktop systems. Its layered-model architecture allows a wide range of software and hardware components to pass information about themselves to an asset management system.

DRAM - An acronym for Dynamic Random Access Memory. A type of memory chip that only keeps its memory if supplied with regular clock pulses and a chance to regularly refresh its data. It is slower and more cost effective than SRAM. See SRAM.

ECP - An acronym for Expanded Capabilities Port. A standard set by Hewlett Packard and Microsoft Corporation to expand the capabilities of the parallel port.

EDO Memory - An acronym for Extended Data Out. A DRAM performance feature that permits multiple bit of data in a single row to be accessed quickly.

EPP - An acronym for Enhanced Parallel Port. A standard which increases the capabilities of the parallel port.

EPROM - Acronym for Erasable Programmable Read Only Memory. A type of ROM chip that can be programmed with relatively simple tools that will retain its data until erased. It can only be erased by exposing the circuitry in the chip to ultraviolet light. See also Flash ROM.

Flash ROM - A type of ROM chip that will retain its data until erased. It can be erased or reprogrammed by supplying it with +12V of voltage. See ROM and EPROM.

FPM - An acronym for Fast Page Mode. A timing option that permits several bits of data in a single row on a DRAM to be accessed at an accelerated rate.

Gigabyte - A disk storage capacity measurement. Approximately one thousand megabytes or 1,073,741,824 bytes.

IDE - An acronym for Integrated Device Electronics. A standard for communicating between a hard drive and a computer.

Internal Cache - Cache which is built into the CPU. See Cache.

ISA - An acronym for Industry Standard Architecture. A well-established bus standard that originated with the IBM AT. See *PCI and VESA Local Bus*.

NLX - A system board size measuring approximately 9" x 10". The NLX design allows better access to upgradeable components inside the system.

NS - An acronym for Nanosecond. One billionth of a second. Measure of the access time of RAM.

Parallel - A form of data transmission in which the data is sent one byte at a time over several wires that each carry one byte. In parallel transmission, all the bytes arrive simultaneously, as opposed to serial transmission in which bits arrive one by one.

Parallel Port - A connection for a printer or similar peripheral. Generally, parallel ports are output only. See *Bi-directional Parallel Port and ECP*.

Parity - Logic that detects the presence of an error in memory. Generally, a single parity bit is used for each byte (8 bits) of data. The most commonly used forms of parity are even parity, odd parity and checksums.

PCI - An acronym for Peripheral Component Interconnect. A high performance 32-bit or 64-bit bus developed by Intel Corporation. PCI is designed to be independent of the hardware architecture to ensure compatibility with future computer systems. See *VESA Local Bus and ISA*.

Pentium - A high performance 64-bit CISC processor designed and manufactured by Intel Corporation.

Pipeline - In DRAMs and SRAMs, a method for increasing the performance using multistage circuitry to stack or save data while new data is being accessed.

Plug and Play - A standard developed to ensure easy installation of peripherals. Theoretically, a newly installed card will automatically configure itself and work properly without requiring jumper configuration or device drivers.

POST - An acronym for Power On Self Test. A diagnostic program that is run whenever the system is cold booted.

RAM - An acronym for Random Access Memory. A type of memory that is used as the "working memory" of a computer system. See *DRAM and SRAM*.

ROM - An acronym for Read Only Memory. A type of memory that retains its data without requiring power. Once written, it cannot be modified. See *EPROM and Flash ROM*.

Serial Port - A communications port used to connect peripherals such as modems and mice.

Setup - A program that allows you to make changes to the system configuration.

Shadow RAM - A technique used to load a duplicate copy of BIOS from slower ROM into faster RAM. This enhances system performance because it provides higher access speed to the BIOS.

SIMM - An acronym for Standard Inline Memory Module. A small printed circuit board containing memory chips.

SDRAM - An acronym for Synchronous Dynamic Random Access Memory or Synchronous DRAM. A DRAM designed to deliver bursts of data at very high speed using automatic addressing, multiple page interleaving and a synchronous (or clocked) interface.

SRAM - An acronym for Static Random Access Memory. A type of memory that can retain data without requiring a regular clock signal. Although they are faster than DRAM, they hold less data and are more expensive.

Synchronous Cache - A type of cache that uses a clock signal to latch the inputs and the data output. This structure spreads the cache access across two or three cycles while maintaining a bandwidth of one access per cycle. Improves performance by 5-10%.

Ultra DMA/33 IDE - A hard drive interface protocol that increases the burst data transfer rate to 33MBytes per second.

Unbuffered DIMMs - The unbuffered DIMM modules do not use any buffer logic chips, thus achieving faster operation due to the elimination of the

propagation delay of the logic buffer. This increase in speed comes at the cost of reducing the maximum number of modules on the same system board.

USB - An acronym for Universal Serial Bus. The simple and flexible way to connect devices to your desktop or notebook PC. USB allows virtually unlimited PC expansion with no more hassles over add-in cards, dip switches, jumper cables, software drivers, IRQ settings, DMA channels and I/O addresses. With USB, you can attach and detach peripherals without opening the computer or even shutting it down.

VESA - An acronym for Video Electronics and Standards Association.

VESA Local Bus (VL-Bus) - A high performance bus designed by VESA. A 32-bit version of the ISA bus which operates at the speed of the computer's CPU. See *PCI and ISA*.

VRM - Voltage Regulator Module. Supplies CPU specific voltages for the Secondary CPU.

Warm Boot - Restarting the system by simultaneously pressing the <Ctrl>, <Alt> and <Delete> keys.

Write-Back Cache - Upon a cache hit, the cache is updated and the main memory is not affected. Upon a cache miss, only the main memory is updated.

Index

B

- Battery Disposal - 52
- POST Messages - 55
- BIOS
 - Configuration - 29
 - Setup - 29
- Bulletin Board System (BBS) - 54

C

- Configuring the Cyclone- 11
- CPU
 - Installation - 24

D

- Diagram
 - Cyclone - 12
 - Riser Card - 13
- Device Drivers - 47

E

- Extended Data Out (EDO) Memory - 19, 21
- Environmental Specifications - 51

F

- Fast Page Mode (FPM) Memory - 19, 21

=====
G

Graphics Drivers - 47

=====
H

Help

Bulletin Board System (BBS) - 54

Telephone Numbers - 54

Troubleshooting - 55, 57

=====
I

Installation

CPU - 24

Installing the Cyclone - 19

ISA Peripheral Card - 26

PCI Peripheral Card - 25

Quick Installation - 9

=====
J

Jumper Settings - 14

=====
M

Memory

Configurations - 22

Installing - 23

Removing - 23

Supported - 19, 21

=====
O

Online Services - 54

P

POST Messages - 55

R

Riser Card - 5, 13

S

SDRAM Memory - 19, 21
Specifications - 49
System BIOS - 29, 63

T

Technical Specifications - 49
Technical Support - 53
Troubleshooting -55, 57

U

Updating the System BIOS - 63
Utility Programs
 Utility Programs
 Advanced Screen - 36
 Advanced Screen Submenu - 38
 BIOS Setup - 29
 Boot Screen - 45
 Exit Screen - 46
 IDE Device Submenu - 34
 Main Screen - 31
 Security Screen - 39

W

World Wide Web - 54