

About This Guide

This User's Guide is for assisting system manufacturers and end users in setting up and installing the mainboard. Information in this guide has been carefully checked for reliability; however, no guarantee is given as to the correctness of the contents. The information in this document is subject to change without notice.

Copyright Notice

Copyright 1994, Soyo Technology Co. Ltd. All rights reserved. This manual is copyrighted by Soyo Technology Co., Ltd. You may not reproduce, transmit, transcribe, store in a retrieval system, or translate into any language, in any form or by any means, electronic, mechanical, magnetic, optical, chemical, manual, or otherwise, any part of this publication without express written permission of Soyo Technology Co., Ltd.

Trademarks

Soyo is a registered trademark of Soyo Technology Co., Ltd. All trademarks are the property of their owners.

Disclaimer

Soyo Technology Co., Ltd. makes no representations or warranties regarding the contents of this manual. We reserve the right to revise the manual or make changes in the specifications of the product described within it at any time without notice and without obligation to notify any person of such revision or change. The information contained in this manual is provided for general use by our customers. Our customers should be aware that the personal computer field is the subject of many patents. Our customers should ensure that they take appropriate action so that their use of our products does not infringe upon any patents. It is the policy of Soyo Technology Co., Ltd. to respect the valid patent rights of third parties and not to infringe upon or assist others to infringe upon such rights.

Restricted rights legend

Use, duplication, or disclosure by the Government is subject to restrictions set forth in subparagraph (c)(1)(ii) of the Rights in Technical Data and Computer Software clause at 252.277-7013.

Edition: December 1994

Version 2.0

030 G/H SERIAL

Table of Contents

Chapter 1: Introduction	1
Key Features.....	1
Unpacking the Mainboard.....	2
Electrostatic Discharge Precautions.....	2
Mainboard Layout w/ default settings*.....	3
Chapter 2: Hardware Setup	4
Jumpers.....	4
JP28: Factory fixed short at pins 2-3, 4-5.....	4
JP29: Reserved.....	4
JP35: Reserved.....	4
JP36: Reserved.....	4
JP37: Reserved.....	4
JP38: Reserved.....	4
JP3: Display Type Settings.....	4
J6: Sleep Switch Connector.....	4
JP5: CMOS Reset Jumper.....	5
JP39: Stopped Clock Generator Select (Fixed at 1-2).....	5
CPU Type Configuration.....	6
Intel/AMID CPU Jumper Settings.....	6
Cyrix CPU Jumper Settings.....	12
UMC CPU Jumper Settings.....	13
Cache Configuration.....	14
Cache Jumper Settings.....	14
Cache Size and RAM Locations.....	14
Memory Configuration.....	17
Connectors.....	18
J17 - Keylock & Power LED Connector.....	18
J18 - Speaker Connector.....	18

J19 - Hardware Reset Control.....	18
J20 - External Battery Connector.....	18
J21 - Turbo Switch Connector.....	18
J22 - Turbo LED Connector.....	18
KB1 - Keyboard Connector.....	19
PS1 - Power Supply Connectors.....	19
JP10 - On-board Primary Hard Disk LED Connector.....	19
JP11 - On-board Secondary Hard Disk LED Connector.....	19
J4 - On-board Primary Hard Disk Connector.....	19
J5 - On-board Secondary Hard Disk Connector.....	19

Chapter 3: BIOS Setup.....	20
Standard CMOS Setup.....	21
BIOS Features Setup.....	22
Chipset Features Setup.....	24
Power Management Setup.....	26
PCI Configuration Setup.....	28
Load Setup Defaults.....	29
Password Setting.....	30
IDE HDD Auto Detection.....	30

1 Introduction

The 486 PCI mainboard is a high-performance system board that supports Intel 486DX2/DX/SX/SL Enhanced 486, P24T, P24D, DX4, Cyrix, AMD, and UMC CPUs. The mainboard is fully compatible with industry standards, while incorporating many technical enhancements.

The 486 PCI mainboard offers superior system performance, compatibility, and reliability, and is the ideal choice for a wide variety of system applications.

Key Features

- Fully AT compatible. Supports Intel 486DX2/DX/SX/SL Enhanced 486, P24T, P24D, 486DX4 (P24C), Cyrix, UMC and AMD CPUs.
- Supports Power Management Mode
 - Supports the SMM and the SMI
 - CPU Stop Clock Function
 - Four Power Saving States (normal / doze / standby / suspend)
 - Supports the APM control
 - Supports Sleep Switch control
 - Power Saving also on non-SMI CPU
 - More System Event Monitoring and Power Saving Control
- Direct map cache controller that supports 256K, 512K, and 1M cache size
- Fast page burst mode DRAM controller
- Memory configurations from 1MB to 255MB using combinations of 80ns 256K, 512K, 1M, 2M, 4M, and 16M SIMM modules. Uses four 72-pin DRAM modules in unrestricted configurations.
- Video ROM Cacheable
- Shadow RAM in Increments of 32KB
- Hardware turbo speed switch
- Four 16-bit ISA slots, three master PCI slots (PCI Bus Spec. Rev. 2.0)
- Support for 5V and 3.45V / 3.6V / 4.0V microprocessors
- On-board local bus IDE Controller
- Built-in NCR 810 PCI SCSI driver

Unpacking the Mainboard*

The mainboard package contains:

- The 486 PCI Mainboard
- This User's Guide

Note: Do not unpack the mainboard until you are ready to install it.

Follow the precautions below while unpacking the mainboard.

1. Before handling the mainboard, ground yourself by grasping an unpainted portion of the system's metal chassis.
2. Remove the mainboard from its anti-static packaging and place it on a grounded surface, component side up.
3. Check the mainboard for damage. If any chip appears loose, press carefully to seat it firmly in its socket.

Do not apply power if the mainboard appears damaged. If there is damage to the board contact your dealer immediately.

Electrostatic Discharge Precautions

Make sure you ground yourself before handling the mainboard or other system components. Electrostatic discharge can easily damage the components. Note that you must take special precaution when handling the mainboard in dry or air-conditioned environments.

Abide by the precautions below to protect your equipment from electrostatic discharge:

- Do not remove the anti-static packaging until you are ready to install the mainboard and other system components.
- Ground yourself before removing any system component from its protective anti-static packaging. To ground yourself, grasp the expansion slot covers or other unpainted portions of the computer chassis.
- Frequently ground yourself while working, or use a grounding strap.
- Handle the mainboard by the edges and avoid touching its components.

Mainboard Layout w/ default settings*

*Default settings are for an Intel DX2-66 SL Enhanced CPU, 256K cache (8 pcs 32K*8), IDE on-board, and power saving controlled by SMOUT signal (JP39).

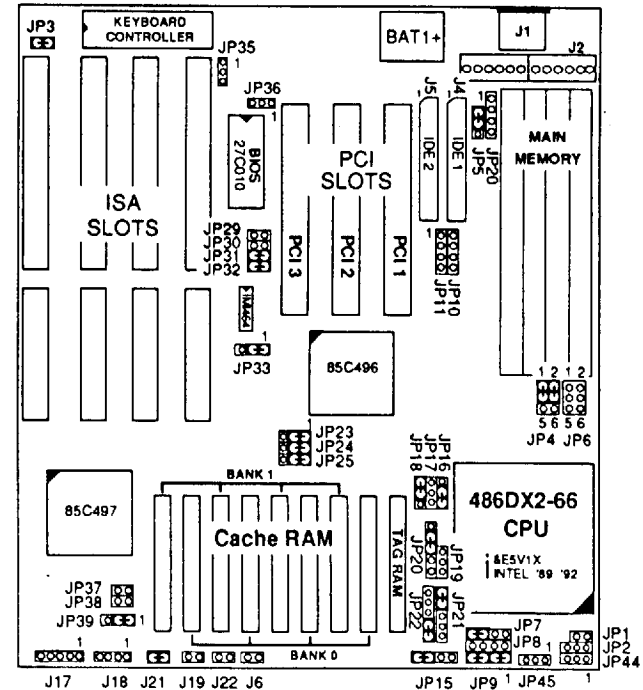

Figure 1-1. Mainboard Layout

Note: If you use a CPU not listed in this manual, please contact your dealer to determine the correct CPU settings.

2 Hardware Setup

This chapter explains how to set jumpers, install a processor and memory on the mainboard and make case connections. Refer to this chapter whenever you upgrade or reconfigure the system.

CAUTION: Turn off power to the mainboard, system chassis, and peripheral devices before performing any work on the mainboard or system.

Jumpers

JP28: Factory fixed short at pins 2-3, 4-5.

JP29: Reserved

JP35: Reserved



JP36: Reserved

JP37: Reserved

JP38: Reserved

JP3: Display Type Settings

JP3 configures the mainboard for use with a color or monochrome monitor.



Display Type	JP3
Monochrome	 1 2
Color/EGA/VGA (Default)	 1 2

J6: Sleep Switch Connector

Toggle this jumper to force the system to enter suspend mode. Press any key or move the input device to wake up the system to full speed mode.



JP5: CMOS Reset Jumper

JP5 lets you discharge CMOS memory in the event you forget your password or encounter a BIOS Setup problem. Before you install the mainboard make sure that JP33 is set to retain CMOS memory.

CMOS Setting	JP5
Retain CMOS Data (Default)	 3 2 1
Discharge CMOS	 3 2 1

JP39: Stopped Clock Generator Select (Fixed at 1-2)

Jumper JP39 sets the STPCLK or SMOUT signal for stopping the clock generator.

Setting	JP39
Stopped by SMOUT for all CPUs. (Default)	 3 2 1
Stopped by STPCLK for all CPUs <i>except</i> AMD DXL CPUs.	 3 2 1

CPU Type Configuration

Configure the 486 PCI mainboard's CPU by inserting the specified CPU and setting jumpers as described in the diagrams that follow. Note that the CPU Type jumpers on the mainboard have yellow caps and the Clock Setting jumpers have red caps.

Intel/AMD CPU Jumper Settings

Intel

486SX/SX SL-Enhanced CPU

486 SX-25/33, 486SX2-50*/66* Settings

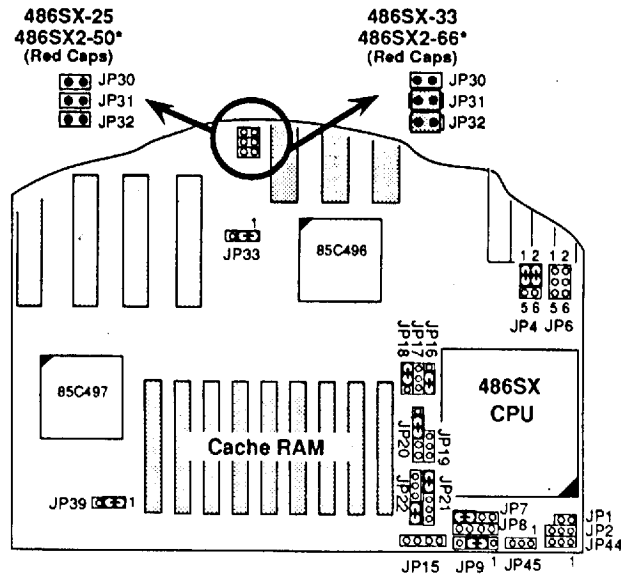

Figure 2-1. 486SX/SL-Enhanced CPU Jumper Settings

* For these CPUs a cooling fan is necessary for system stability.

Intel 486DX/DX SL-Enhanced, DX4 ODP (5V) CPU DX-25/33/40*/50*, DX2-50*/66*/80* Settings

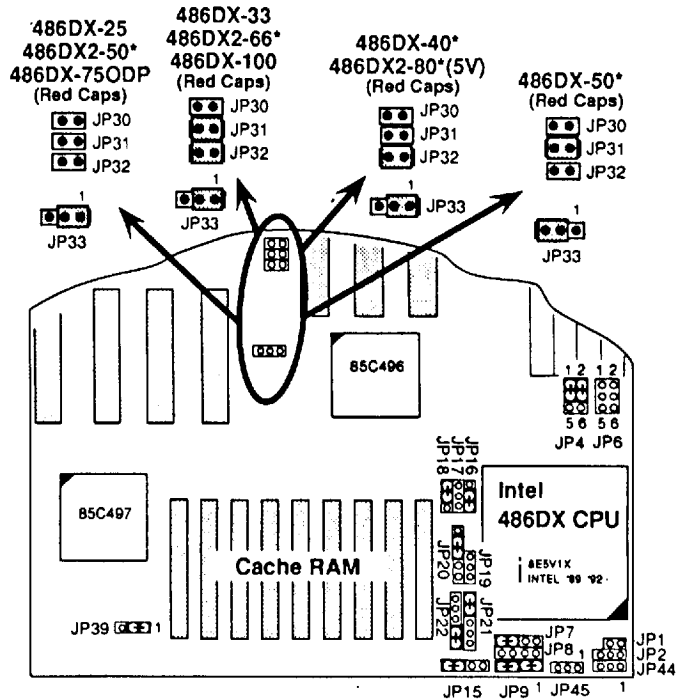

Figure 2-2. 486DX/DX SL-Enhanced, DX4 ODP (5V) CPU Jumper Settings

* For these CPUs a cooling fan is necessary for system stability.

Note: Do not change the JP4 setting, the Intel DX4ODP CPU is a 5V CPU.

Intel DX4 (3.45V) CPU DX4-75*/100* Settings

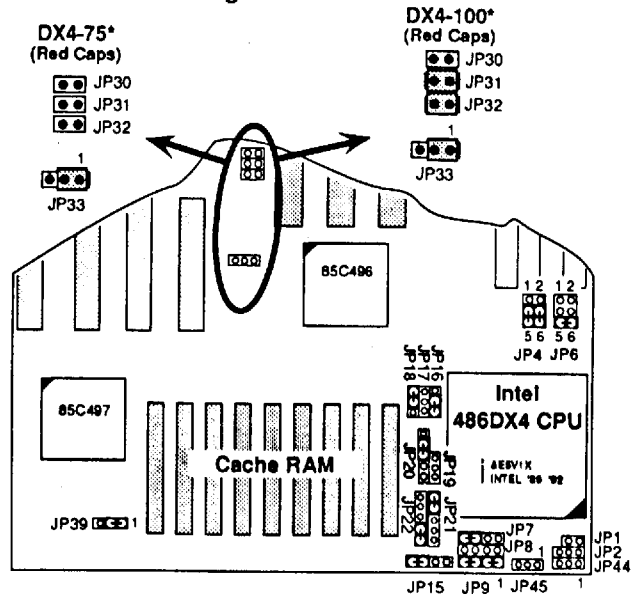

Figure 2-3. Intel DX4 (3.45V) CPU Jumper Settings

* For these CPUs a cooling fan is necessary for system stability.

Note: The Intel DX4-75/100 is a 3.45V CPU. You must set JP4 and JP6 as shown above.

Intel P24D CPU (Internal write-back cache) P24D-50*/66* Settings

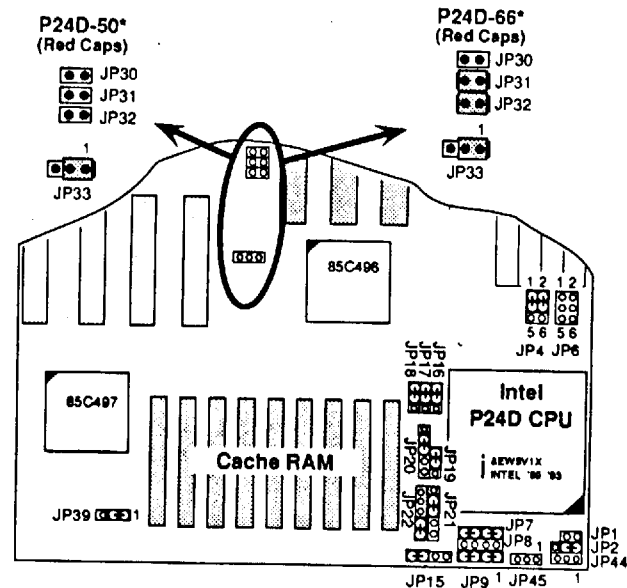

Figure 2-4. Intel P24D CPU Settings

* For these CPUs a cooling fan is necessary for system stability.

Intel P24T CPU (Pentium Overdrive 238-pin,
Internal 2.5x clock, Internal write-back cache)
P24T-63*/83* Settings

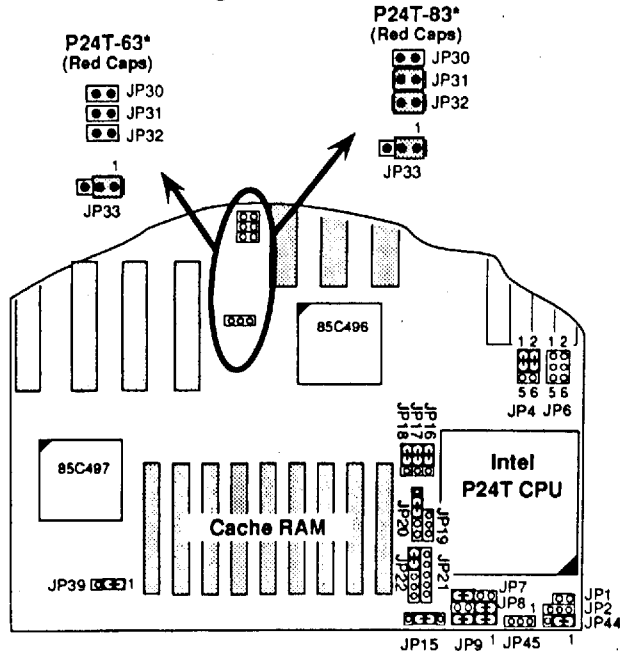

Figure 2-5. Intel P24T CPU Jumper Settings

* For these CPUs a cooling fan is necessary for system stability.

AMD DX2-66*/80*, DX4-100* (3.45V) CPU Settings

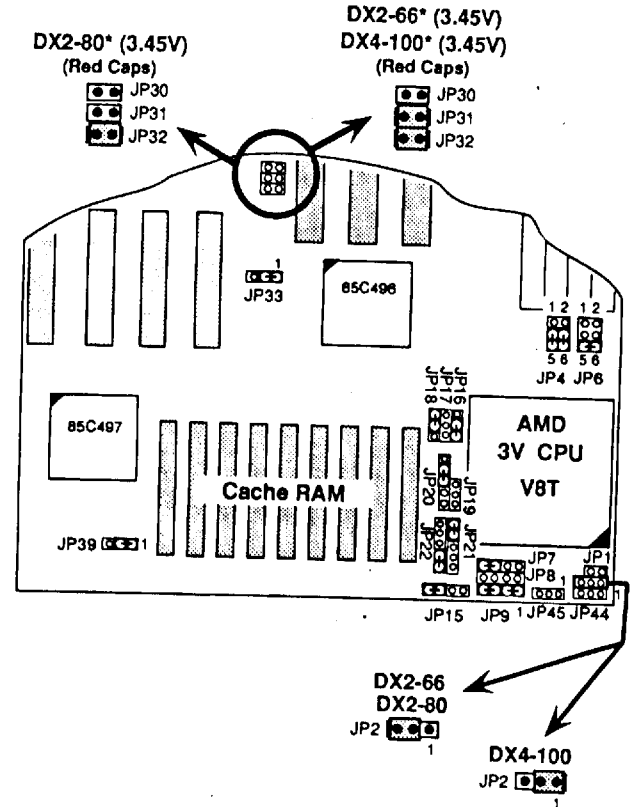

Figure 2-6. AMD DX2-66/80, DX4-100 (3.45V) CPU Jumper Settings

* For these CPUs a cooling fan is necessary for system stability.

Note: If the AMD CPU has V8T/V8B marked on the surface, it indicates a 3.45V CPU. You must set JP4 and JP6 as shown above.

Cyrrix CPU Jumper Settings

Cyrrix DX/DX2 CPU

DX-33/40*/50*, DX2-50*/66* (5V), DX2-V50*/V66* (3.6V),
DX2-V80* (4V) Settings

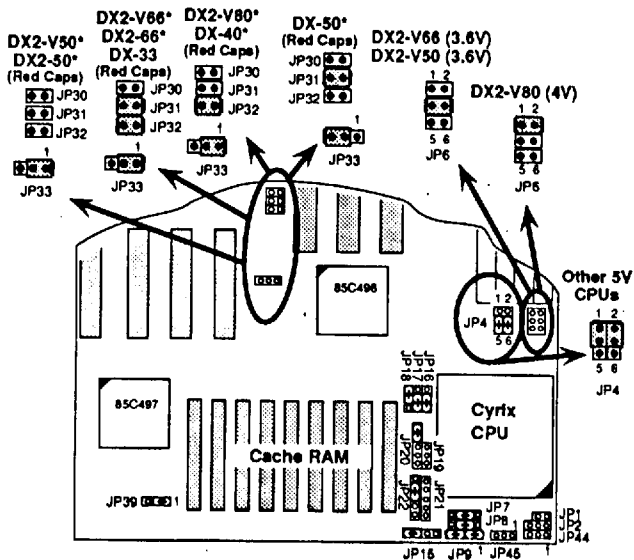

Figure 2-7. Cyrix DX/DX2 CPU Jumper Settings

* For these CPUs a cooling fan is necessary for system stability.

WARNING: The Cyrix DX2-V66 CPU is a 3.6V CPU. Make sure JP4 and JP6 are set correctly as shown above to avoid damaging the CPU.

Note: If the Cyrix has Vxx marked on the CPU's surface, it indicates a 3.6 volt or 4 volt CPU. You must set JP4 and JP6 as shown above.

UMC CPU Jumper Settings

UMC U5S (Green) CPU

U5S-25/33*/40* Settings

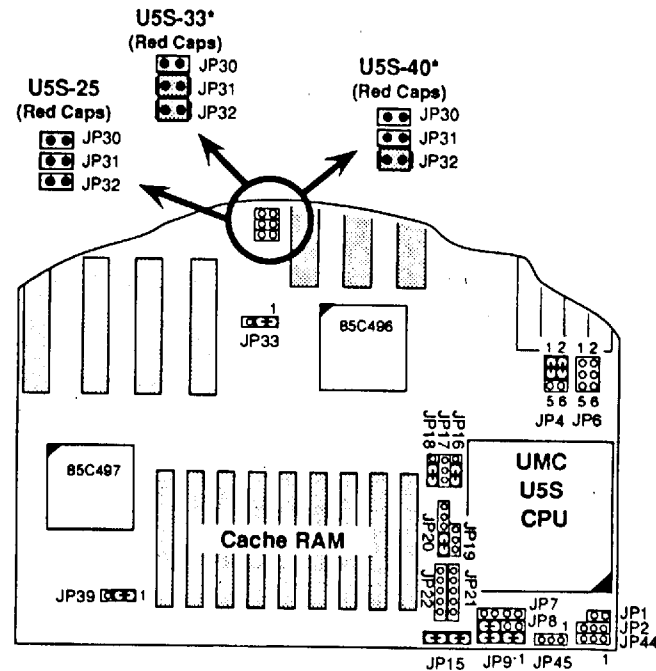

Figure 2-8. UMC U5S CPU (Green) Jumper Settings

* For these CPUs a cooling fan is necessary for system stability.

Cache Configuration

The 486 PCI mainboard has a write-back caching scheme. You can configure the mainboard's external cache for 256KB, 512KB, or 1MB by setting jumper switches and installing cache chips. Refer to the following pages for jumper switch settings and cache socket locations.

Cache Jumper Settings

You must set jumpers JP23-JP25 to configure cache size. See the illustrations below. Note that cache jumpers on the mainboard have **white** jumper caps.

Cache Size and RAM Locations

You can configure cache size using 32Kx8, 64Kx8, or 128Kx8 cache chips. The table below describes chip type and socket locations for each configuration.

Cache Size	Cache RAM	Tag RAM	Cacheable Range
256KB	32K x 8 / U9, U10, U11, U14, U19, U20, U24, U25	32K x 8 / U8 or 16K x 8 / U8	64MB
256KB	64K x 8 / U9, U11, U19, U24	32K x 8 / U8 or 16K x 8 / U8	64MB
512KB	64K x 8 / U9, U10, U11, U14, U19, U20, U24, U25	32K x 8 / U8	128MB
512KB	128K x 8 / U9, U11, U19, U24	32K x 8 / U8	128MB
1MB	128K x 8 / U9, U10, U11, U14, U19, U20, U24, U25	64K x 8 / U8	256MB

Note: Tag and Data RAM use 20ns for all conditions.

256K Cache (32K*8 8pcs) Configuration

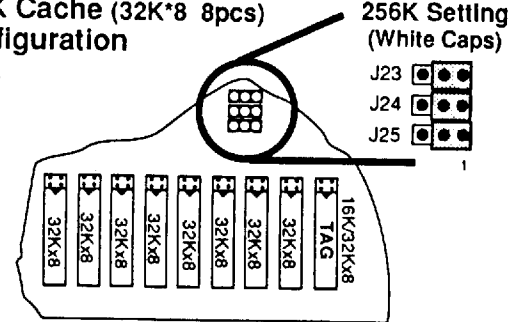

Cache Size	JP23	JP24	JP25
256K (32K*8 8pcs)	1-2	1-2	1-2

256K Cache (64K*8 4pcs) Configuration

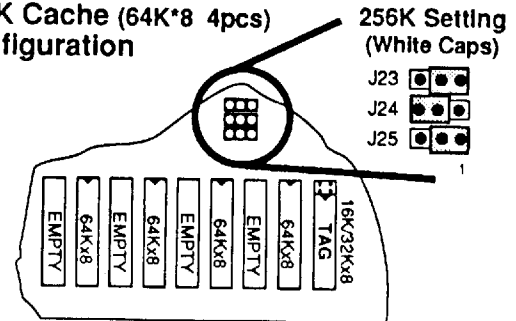

Cache Size	JP23	JP24	JP25
256K (64K*8 4pcs)	1-2	2-3	1-2

512K Cache (64K*8 8pcs) Configuration

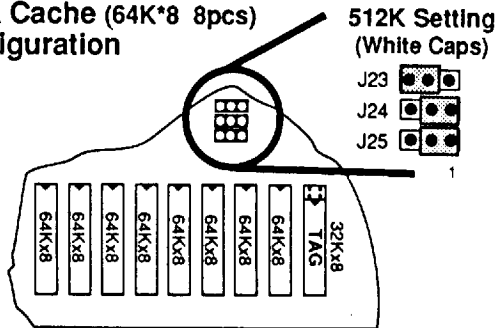

Cache Size	JP23	JP24	JP25
512K (64K*8 8pcs)	2-3	1-2	1-2

512K Cache (128K*8 4pcs) Configuration

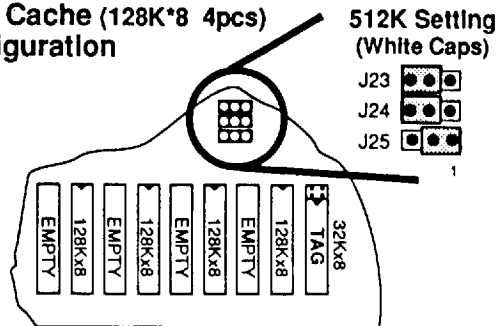

Cache Size	JP23	JP24	JP25
512K (128K*8 4pcs)	2-3	2-3	1-2

1M Cache (128K*8 8pcs) Configuration

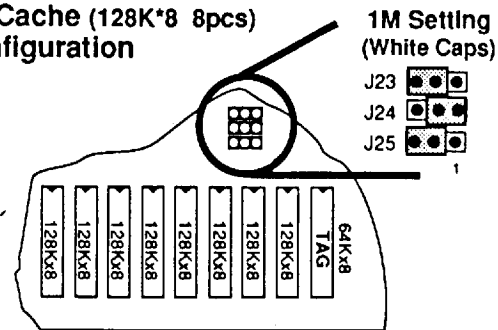

Cache Size	JP23	JP24	JP25
1M (128K*8 8pcs)	2-3	1-2	2-3

Note: This mainboard supports 1M cache capability, however, the user is responsible for installing the 8pcs of 128K*8 SRAM. The board maker does not provide 1M cache components.

Memory Configuration

The mainboard supports four banks of 72-pin SIMM (Single In-line Memory Modules). The mainboard requires SIMM of at least 80ns access time.

Single-Sided SIMM	Double-Sided SIMM
1MB = 256K x 36(32)	2MB = 512K x 36(32)
4MB = 1MB x 36(32)	8MB = 2MB x 36(32)
16MB = 4MB x 36(32)	32MB = 8MB x 36(32)
64MB = 16MB x 36(32)	

There are *no restrictions* on memory configuration. You can install DRAM in any combination without having to rely on a memory configuration table. Memory configuration is thus "Table-Free."

Connectors

Attach the 486 PCI mainboard to case devices, or an external battery, via connectors on the mainboard. Refer to Figure 1-1 for connector locations and connector pin positions.

J17 - Keylock & Power LED Connector

J17 is a connector for a lock that may be installed on the system case for enabling or disabling the keyboard. J17 also attaches to the case's Power LED.



J18 - Speaker Connector

Attach the system speaker to connector J18.

J19 - Hardware Reset Control

Attach the Reset switch to J19. Closing the Reset switch restarts the system.

J20 - External Battery Connector

J20 is a 4-pin connector to which you can attach an external battery. Pin 1 of J20 is positive (+) and pin 4 is negative (-).

J21 - Turbo Switch Connector

J21 is connected to a Turbo switch on the front of the system case. The connector's pins are shorted for normal operation and open for turbo operation.



J22 - Turbo LED Connector

J22 connects to a Turbo LED on the case control panel and works with the Turbo Switch. If the mainboard is in Turbo mode, the Turbo LED lights. When the LED flashes, it means the system has entered power saving mode.

KB1 - Keyboard Connector

A five-pin female DIN keyboard connector is located at the rear of the board. Plug the keyboard jack into this connector.

PS1 - Power Supply Connectors

The mainboard requires a power supply with at least 200 watts and a "power good" signal. PS1 has two six-pin male header connectors.

Plug the dual connectors from the power directly onto the board connector while making sure the black leads are in the center.

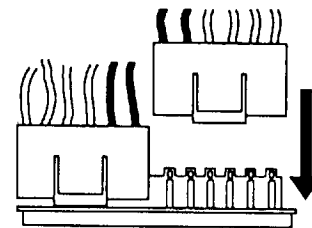

JP10 - On-board Primary Hard Disk LED Connector

(pin 1, 4 : 5V , pin 2, 3 : Signal)

JP11 - On-board Secondary Hard Disk LED Connector

(pin 1, 4 : 5V , pin 2, 3 : Signal)



J4 - On-board Primary Hard Disk Connector

J5 - On-board Secondary Hard Disk Connector

You can enable/disable JP4 / JP5 via BIOS control (see page 24).

512K Cache (64K*8 8pcs) Configuration

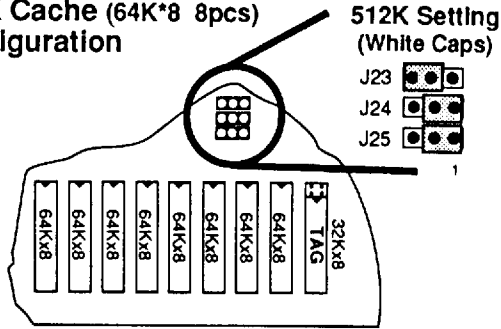

Cache Size	JP23	JP24	JP25
512K (64K*8 8pcs)	2-3	1-2	1-2

512K Cache (128K*8 4pcs) Configuration

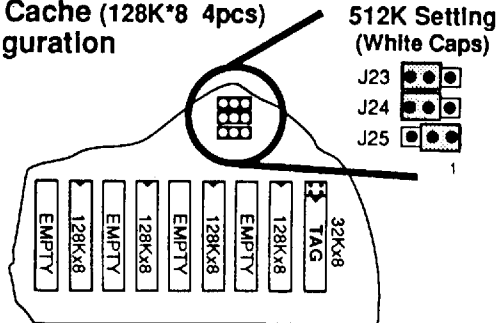

Cache Size	JP23	JP24	JP25
512K (128K*8 4pcs)	2-3	2-3	1-2

1M Cache (128K*8 8pcs) Configuration

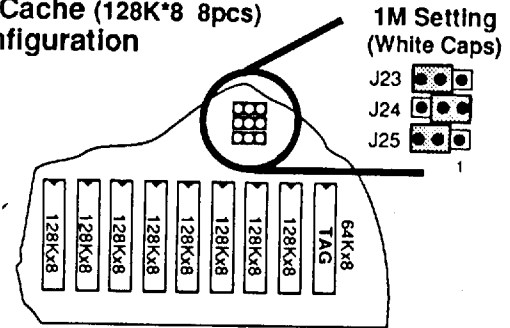

Cache Size	JP23	JP24	JP25
1M (128K*8 8pcs)	2-3	1-2	2-3

Note: This mainboard supports 1M cache capability, however, the user is responsible for installing the 8pcs of 128K*8 SRAM. The board maker does not provide 1M cache components.

Memory Configuration

The mainboard supports four banks of 72-pin SIMM (Single In-line Memory Modules). The mainboard requires SIMM of at least 80ns access time.

Single-Sided SIMM

1MB = 256K x 36(32)
4MB = 1MB x 36(32)
16MB = 4MB x 36(32)
64MB = 16MB x 36(32)

Double-Sided SIMM

2MB = 512K x 36(32)
8MB = 2MB x 36(32)
32MB = 8MB x 36(32)

There are *no restrictions* on memory configuration. You can install DRAM in any combination without having to rely on a memory configuration table. Memory configuration is thus "Table-Free."

3 BIOS Setup

The mainboard's BIOS setup program is the ROM ISA BIOS from Award Software Inc. Enter the Award BIOS program's Main Menu as follows:

1. Turn on or reboot the system. After a series of diagnostic checks, you are asked to press DEL to enter Setup.
2. Press the key to enter the Award BIOS program and the main screen appears:

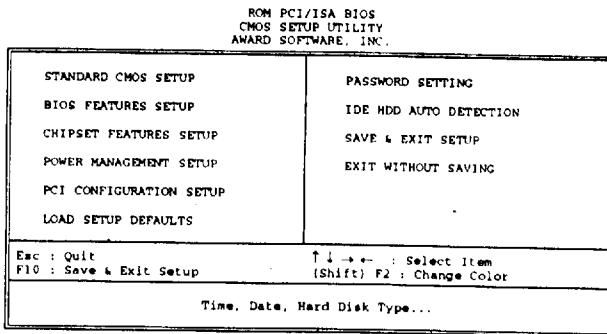

3. Choose an option and press <Enter>. Modify the system parameters to reflect the options installed in the system. (See the following sections.)
4. Press <ESC> at anytime to return to the Main Menu.
5. In the Main Menu, choose "SAVE AND EXIT SETUP" to save your changes and reboot the system. Choosing "EXIT WITHOUT SAVING" ignores your changes and exits the program.

The Main Menu options of the Award BIOS are described in the sections that follow.

Standard CMOS Setup

Run the Standard CMOS Setup as follows.

1. Choose "STANDARD CMOS SETUP" from the Main Menu. A screen appears.

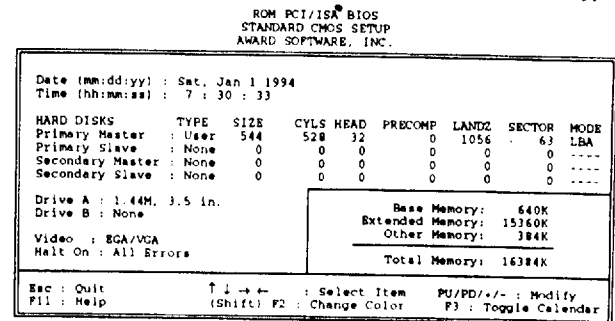

2. Use arrow keys to move between items and select values. Modify selected fields using PgUp/PgDn/+/- keys. Some fields let you key in values directly.

- Date (mm/dd/yy)** Type the current date.
- Time (hh:mm:ss)** Type the current time.
- Primary (Secondary) Master & Slave** Choose from the standard hard disk types 1 to 46. Type 47 is user definable. If a hard disk is not installed choose "Not installed." (default)
- Drive A & B** Choose 360KB, 5 1/4", 1.2MB, 5 1/4", 720KB, 3 1/2", 1.4M, 3 1/2"(default), 2.88 MB, 3 1/2" or Not installed
- Video** Choose Monochrome, Color 40x25, VGA/EGA (default), Color 80x25

3. When you finish, press the <ESC> key to return to the Main Menu.

BIOS Features Setup

Run the BIOS Features Setup as follows.

1. Choose "BIOS FEATURES SETUP" from the Main Menu and a screen with a list of items appears. (The screen below shows BIOS default settings.)

ROM PCI/ISA BIOS BIOS FEATURES SETUP AWARD SOFTWARE, INC.			
CPU Internal Cache	: Enabled	Video BIOS Shadow	: Enabled
External Cache	: Enabled	C8000-CFFFF Shadow	: Disabled
Quick Power On Self Test	: Disabled	D0000-D7FFF Shadow	: Disabled
Boot Sequence	: A,C	D8000-DFFFF Shadow	: Disabled
Swap Floppy Drive	: Disabled	E0000-E7FFF Shadow	: Disabled
Boot Up NumLock Status	: On	E8000-EFFFF Shadow	: Disabled
IDE HDD Block Mode	: Enabled		
IDE 32-bit Transfer Mode	: Disabled		
Gate A20 Option	: Fast		
Memory Parity Check	: Disabled		
Typematic Rate Setting	: Disabled		
Typematic Rate (Chars/Sec)	: 6		
Typematic Delay (Msec)	: 250		
Security Option	: Setup		
IDE Second Channel Control	: Enabled		

ESC	: Quit	↑ ↓ → ←	: Select Item
F1	: Help	FU/PD/+/-	: Modify
F5	: Old Values (Shift)	F2	: Color
F6	: Load BIOS Defaults		
F7	: Load Setup Defaults		

2. Use the arrow keys to move between items and select values. Modify selected fields using PgUp/PgDn/+/- keys. <F> keys are explained below:

- <F1>: "Help" gives options available for each item.
 Shift <F2>: Change color.
 <F5>: Get the old values. These values are the values with which the user started the current session.
 <F6>: Load all options with the BIOS Setup default values.
 <F7>: Load all options with the Setup default values.

A short description of screen items follows:

- CPU Internal Cache** This option enables/disables the CPU's internal cache memory. (The Default setting is Enabled.)
- External Cache** This option enables/disables the external cache memory. (The Default setting is Enabled.)
- Quick Power On Self Test** Enabled provides a fast POST at boot-up.

- Boot Sequence** The default setting attempts to first boot from drive A: and then from hard disk C:. You can reverse this sequence with "C: A:", but then drive A: cannot boot directly.
- Swap Floppy Drive** Enabled changes the sequence of the A: and B: drives. (The Default setting is Disabled.)
- Boot Up Num Lock Status** Choose On or Off. On puts numeric keypad in Num Lock mode at boot-up. Off puts this keypad in arrow key mode at boot-up.
- IDE HDD Block Mode** This option enables/disables the IDE HDD Block Mode function. Not all HDDs support this function.
- IDE 32-bit Transfer Mode** Choose Enabled or Disabled (Default). Select Enabled to use the DOS mode driver built in to the BIOS — there's no need for the User to install a driver. Select Disabled to run an IDE HDD under 16-bit transfer mode.
- Gate A20 Option** Choose Fast or Normal. Fast allows RAM accesses above 1MB using the fast gate A20 line.
- Memory Parity Check** This option enables / disables the memory parity check function. (The Default setting is Disabled.)
- Typematic Rate Setting** Enable this option to adjust the keystroke repeat rate.
- Typematic Rate (Chars/Sec)** Choose the rate a character keeps repeating.
- Typematic Delay (Msec)** Choose how long after you press a key that a character begins repeating.
- Security Option** Choose Setup or System. Use this feature to prevent unauthorized system boot-up or use of BIOS Setup.
 "System" – Each time the system is booted the password prompt appears.
 "Setup" – If a password is set, the password prompt only appears if you attempt to enter the Setup program.
- IDE Second Channel Control** Choose Enabled or Disabled. When Enabled is set, IRQ15 is dedicated for secondary IDE use. When Disabled is set, IRQ15 is released for other devices.

**Video or
Adaptor BIOS
Shadow**

BIOS shadow copies BIOS code from slower ROM to faster RAM. BIOS can then execute from RAM. These 32K segments can be shadowed from ROM to RAM. BIOS is shadowed in a 32K segment if it is enabled and it has BIOS present.

- After you have finished the BIOS Features Setup program, press the <ESC> key and follow the screen instructions to save or disregard your settings.

Chipset Features Setup

The Chipset Features Setup option changes the values of the chipset registers. These registers control system options in the computer.

Note: Change these settings only if you are familiar with the Chipset.

Run the Chipset Features Setup as follows.

- Choose "CHIPSET FEATURES SETUP" from the Main Menu and the following screen appears. (The screen below shows default settings.)

ROM PCI/ISA BIOS CHIPSET FEATURES SETUP AMARD SOFTWARE, INC.			
Auto Configuration	: Enabled	Onboard 496B IDE Port	: Enabled
ISA Bus Clock Option	: 1/4 PCLK	IDE0 Master Mode	: Auto
LBD# Sample Point	: End of T2	IDE0 Slave Mode	: Auto
DRAM Speed	: Slower	IDE1 Master Mode	: Auto
DRAM Write Cycle	: 1 WS	IDE1 Slave Mode	: Auto
DRAM Write CAS Pulse	: 2 CCLK		
CPU Burst Write	: Disabled		
L2 Cache Policy	: Write Back		
Cache Write Cycle	: 3 CCLK		
Cache Burst Read Cycle	: 2 CCLK		
L2 Cache/DRAM Read Cycle	: 3 CCLK		
		ESC : Quit	F10 : Select Item
		F1 : Help	PU/PD/+/- : Modify
		F5 : Old Values (Shift)F2 : Color	
		F6 : Load BIOS Defaults	
		F7 : Load Setup Defaults	

- Use the arrow keys to move between items and select values. Modify selected fields using the PgUp/PgDn/+/- keys.

A short description of screen items follows:

Auto Configuration

Enable this option (strongly recommended) and the system automatically sets all options on the left side of the screen (except cache update mode & BIOS cacheable).

If this option is Enabled you must boot from Turbo mode.

ISA Bus Clock

The default setting is 1/4 PCLK (assuming PCLK is 33MHz.) It is recommended that you do not change this setting. This value should be close to 8MHz.

LBD# Sample Point

Use the default setting.

DRAM Speed

Automatically set by BIOS.

DRAM Write Cycle

Automatically set by BIOS.

DRAM Write CAS Pulse

Automatically set by BIOS.

CPU Burst Write

Choose Enabled or Disabled. The default is Disabled.

L2 Cache Policy

Choose Write-through or Write-back. The default is Write-back.

Cache Write Cycle

Use the default setting.

Cache Burst Read Cycle

Use the default setting.

L2 Cache / DRAM Cycle WS

Use the default setting.

Onboard VESA IDE Port

Choose Enabled (default) or Disabled. The Enabled setting enables both primary and secondary IDEs. The Disabled setting turns off the primary IDE and the Secondary IDE.

IDE 0/1 Master/Slave Mode

Choose Auto (default) or 0,1,2,3,4. The 0-4 settings are for IDE mode speed. (Mode 0 is the slowest speed, Mode 4 is the fastest). Unless you know the HDD speed, you should use the **Auto** setting for more reliable and better performance.

- After you have finished with the Chipset Features Setup, press the <ESC> key and follow the screen instructions to save or disregard your settings.

Power Management Setup

The Power Management Setup option sets the system's power saving functions.

Run the Power Management Setup as follows.

1. Choose "POWER MANAGEMENT SETUP" from the Main Menu and a screen with a list of items appears.

ROM PCI/ISA BIOS POWER MANAGEMENT SETUP AWARD SOFTWARE, INC.			
Power Management	: Disabled	IRQ3 (COM 2)	: Enabled
PM Control By APM	: No	IRQ4 (COM 1)	: Enabled
Video Off Option	: Susp_Stby-> Off	IRQ5 (LPT 2)	: Enabled
Video Off Method	: V/H SYNC+Blank	IRQ6 (Floppy Disk)	: Enabled
Suspend Switch	: Enabled	IRQ7 (LPT 1)	: Enabled
PM Interrupt Use	: IRQ 12	IRQ8 (RTC Alarm)	: Disabled
** PM Timers **			
HDD Off After	: Disabled	IRQ9 (IRQ2 Redir)	: Enabled
Doze Mode	: Disabled	IRQ10 (Reserved)	: Enabled
Standby Mode	: Disabled	IRQ11 (Reserved)	: Enabled
Suspend Mode	: Disabled	IRQ12 (PS/2 Mouse)	: Enabled
** PM Events **			
PCI Master Activity	: Enabled	IRQ13 (Coprocessor)	: Enabled
COM Ports Activity	: Enabled	IRQ14 (Hard Disk)	: Enabled
LPT Ports Activity	: Enabled	IRQ15 (Reserved)	: Enabled
HDD Ports Activity	: Enabled		
DMA Ports Activity	: Enabled		
VGA Ports Activity	: Disabled		
ESC : Quit ↑ ↓ → ← : Select Item			
F1 : Help PU/PD/+/- : Modify			
F5 : Old Values (Shift)F2 : Color			
F6 : Load BIOS Defaults			
F7 : Load Setup Defaults			

2. Use the arrow keys to move between items and to select values. Modify the selected fields using the PgUp/PgDn/+/- keys.

A short description of selected screen items follows:

Power Management Options are as follows:

User Define Let's you define the HDD and system power down times.

Disabled Disables the Green PC Features.

Min Saving Doze Mode = 3 Hr
Standby Mode = 3 Hr
Suspend Mode = 3 Hr

Max Saving Doze timer = 10 Sec
Standby Mode = 10 Sec
Suspend Mode = 10 Sec

PM Control by APM Choose Yes or No (default). APM stands for Advanced Power Management. To use APM you must run "power.exe" under DOS v6.0 or later version.

Video Off Option

When Suspend mode occurs, the monitor screen shuts off. If any IRQ event occurs, the screen comes back on.

Video Off Method

When Suspend mode occurs, the monitor screen shuts off. If any IRQ event occurs, the screen comes back on.

PM Interrupt Use

This item is only valid for Non-SMI CPUs. It is recommended that you use the default setting (IRQ12). (Assign the Non-SMI routine to a dedicated IRQ.)

HDD Off After

When the set time has elapsed, the BIOS sends a command to the HDD to enter standby (sleep) mode, which turns off the motor. Time is adjustable from 1 to 15 minutes. The default setting is Disabled. Some older model HDDs may not support this advanced function.

Doze Mode

When the set time has elapsed, the BIOS sends a command to the system to enter doze mode (system clock drops to 8MHz). Time is adjustable from 10 Sec to 3 Hr.

Standby Mode

When the set time has elapsed, the BIOS sends a command to the system to enter Standby mode (system clock drops to 8MHz). Time is adjustable from 10 Sec to 3 Hr.

Suspend Mode

When the set time has elapsed, the BIOS sends a command to the system to enter Suspend mode (system clock drops to 8MHz). Time is adjustable from 10 Sec to 3 Hr.

PCI Master Activity

The hardware monitors the master signals for activity. If activity occurs from the Enabled item, the system will not enter Green mode (power saving.)

xxx Ports Activity

The hardware monitors these ports for activity. If activity occurs from the Enabled item the system will not enter Green mode (power saving.)

IRQx

The BIOS monitors these items for activity. If activity occurs from the Enabled item the system will not enter Green mode (power saving.)

3. After you have finished with the Power Management Setup, press the <ESC> key to return to the Main Menu.

PCI Configuration Setup

This option sets the mainboard's PCI Slots. Run this option as follows:

1. Choose "PCI CONFIGURATION SETUP" from the Main Menu and the following screen appears. (The screen below shows default settings.)

ROM PCI/ISA BIOS PCI CONFIGURATION SETUP AWARD SOFTWARE, INC.	
SLOT 1 Using INT #	: AUTO
SLOT 2 Using INT #	: AUTO
SLOT 3 Using INT #	: AUTO
SLOT 4 Using INT #	: AUTO
1st Available IRQ	: 9
2nd Available IRQ	: 10
3rd Available IRQ	: 11
4th Available IRQ	: 12
PCI IRQ Activated By	: Level
PCI IDE IRQ Map To	: PCI-AUTO
Primary IDE INT#	: A
Secondary IDE INT#	: B
Master Arbitration Protocol:	Weak
CPU->PCI Mem Post Write Buf:	Disabled
PCI Master Burst Read/Write:	Disabled
ESC : Quit ↑ ↓ → ← : Select Item F1 : Help PU/PD+/- : Modify F5 : Old Values (Shift) F2 : Color F6 : Load BIOS Defaults F7 : Load Setup Defaults	

2. Use the arrow keys to move between items and select values. Modify selected fields using the PgUp/PgDn/+/- keys.

A short description of screen items follows:

Slot 1 (2) (3) (4) Using INT# Choose AUTO or assign PCI INT# number A, B, C, or D. The default setting is AUTO.

1st (2nd) (3rd) (4th) Available IRQ If slot 1-4 is set to AUTO in the item above, then the BIOS automatically routes the INT# to the specified IRQ following the 1st (2nd) (3rd) (4th) IRQ order you assign.

PCI IRQ Activated By Choose Edge or Level. Most PCI trigger signals are Level. This setting must match the PCI card.

PCI IDE IRQ Map To Select PCI-AUTO, ISA, or assign a PCI SLOT number (depending on which slot the PCI IDE is inserted). The default setting is PCI-AUTO. If PCI-AUTO does not work, then assign an individual PCI SLOT number.

Primary IDE INT# Choose INTA#, INTB#, INTC#, or INTD#. The default setting is INTA#.

Secondary IDE INT# Choose INTA#, INTB#, INTC#, or INTD#. The default setting is INTB#.

Monitor Event in Inactive Mode The BIOS monitors these items for activity while the system is in the ON mode or the Inactive mode.

Master Arbitration Protocol Choose Weak (default) or Strong. Choose Weak and the CPU has 1st priority, 2nd is PCI and 3rd is Master Device. Choose Strong and the CPU, PCI, and Master Device all have the same priority.

CPU->PCI Mem Post Write Buf Choose Enabled or Disabled.

PCI Master Burst Read/Write Choose Enabled or Disabled.

3. After you have finished with the PCI Slot Configuration, press the <ESC> key and follow the screen instructions to save or disregard your settings.

Load Setup Defaults

This item loads the system values you have previously saved. Choose this item and the following message appears:

"Load SETUP Defaults (Y/N)? N"

To use the SETUP defaults, change the prompt to "Y" and press <Enter>.

Password Setting

This Main Menu item lets you configure the system so that a password is required every time the system boots or an attempt is made to enter the Setup program. Change the password as follows:

1. Choose "PASSWORD SETTING" in the Main Menu and press <Enter>. The following message appears:

"Enter Password:"

2. Enter a password and press <Enter>.

(If you do not wish to use the password function, you can just press <Enter> and a "Password disabled" message appears.)

3. After you enter your password, the following message appears prompting you to confirm the new password:

"Confirm Password:"

4. Re-enter your password and then Press <ESC> to exit to the Main Menu.

Important: If you forget or lose the password, the only way to access the system is to set jumper JP5 to clear the CMOS RAM. All setup information is lost and you must run the BIOS setup program again.

IDE HDD Auto Detection

This Main Menu item automatically detects the hard disk type and configures the STANDARD CMOS SETUP accordingly.

Note: This function is only valid for IDE hard disks.

```

ROM PCI/ISA BIOS
CMOS SETUP UTILITY
AWARD SOFTWARE, INC.
  
```

		CYLS.	HEADS	PRECOMP	LANDZONE	SECTORS
Drive C : User (49Mb)	790	15	65535	789	57
Drive D : User (0Mb)	0	0	0	0	0

Do you accept this drive C (Y/N)? N

ESC : Skip

NOTE