

5AX

USER'S MANUAL

- * Support Intel Pentium, MMX, Cyrix/IBM 6x86MX, MII, AMD K5, K6, K6-2 & IDT C6 CPUs.
- * Support auto detect CPU Voltage.
- * Support Parity check or Ecc Function.
- * Support Fully AGP 1.0 Specification.
- * Support switching mode Voltage regulator on Board.
- * Support 66/75/83/95 MHz and 100MHz are optional.
- * Support Modem Ring On (COM B).
- * Support Wake on Lan(The ATX power supply supports larger than 600 mA).
- * Support Keyboard Power ON/OFF function.
- * Thermal Protection

**Pentium[®] Processor PCI - ISA BUS MAINBOARD
REV. 3.0 Second Edition**

R-30-02-080805

The author assumes no responsibility for any errors or omissions which may appear in this document nor does it make a commitment to update the information contained herein.

*THIRD-PARTY BRANDS AND NAMES ARE THE PROPERTY OF THEIR RESPECTIVE OWNERS.

Aug 5, 1998 Taipei, Taiwan

I. CPU Jumper Setting Table:

◆ SW: CPU INT./ EXT. FREQ. RATIO

O	ON
X	OFF

SW	2	3	8
x 1.5	X	X	X
x 2	O	X	X
x 2.5	O	O	X
x 3	X	O	X
x 3.5	X	X	X
x 4	O	X	O
x 4.5	O	O	O
x 5	X	O	O
x 5.5	X	X	O

SW	4	5	6	7
AUTO	X	X	X	O
2.0 V	X	X	X	X
2.1 V	X	X	O	X
2.2 V	X	O	X	X
2.3 V	X	O	O	X
2.4 V	O	X	X	X
2.5 V	O	X	O	X
2.6 V	O	O	X	X
2.7 V	O	O	O	X
2.8 V	X	X	X	O
2.9 V	X	X	O	O
3.0 V	X	O	X	O
3.1 V	X	O	O	O
3.2 V	O	X	X	O
3.3 V	O	X	O	O
3.4 V	O	O	X	O
3.5 V	O	O	O	O

CPU	AGP	SW1	JP7	JP8	JP9
100	66	OFF	1-2	1-2	2-3
95	63	ON	1-2	1-2	2-3
83	66	OFF	1-2	2-3	2-3
75	75	OFF	2-3	1-2	2-3
75	60	ON	1-2	2-3	2-3
66	66	OFF	2-3	2-3	2-3

● The default setting is 100*3 at 2.2V for AMD K6/300 and AMD K6-2/300

CPU	SW1	SW2	SW ₃	SW4	SW5	SW6	SW7	SW8	JP7	JP8	JP9

AMD-K6/300 (100*3 2.2V) AMD-K6-2/300 (100*3 2.2V)	OFF	OFF	ON	OFF	ON	OFF	OFF	OFF	1-2	1-2	2-3
--	-----	-----	----	-----	----	-----	-----	-----	-----	-----	-----

II. Quick Installation Guide:

CPU	SW1	SW2	SW3	SW4	SW5	SW6	SW7	SW8	JP7	JP8	JP9
1. Pentium® Processor 100 MHz	OFF	OFF	OFF	OFF	OFF	OFF	ON	OFF	2-3	2-3	2-3
2. Pentium® Processor 133 MHz	OFF	ON	OFF	OFF	OFF	OFF	ON	OFF	2-3	2-3	2-3
3. Pentium® Processor 166 MHz	OFF	ON	ON	OFF	OFF	OFF	ON	OFF	2-3	2-3	2-3
4. Pentium® Processor 200 MHz	OFF	OFF	ON	OFF	OFF	OFF	ON	OFF	2-3	2-3	2-3
5. Intel MMX-166MHz	OFF	ON	ON	OFF	OFF	OFF	ON	OFF	2-3	2-3	2-3
6. Intel MMX-200MHz	OFF	OFF	ON	OFF	OFF	OFF	ON	OFF	2-3	2-3	2-3
7. Intel MMX-233MHz	OFF	OFF	OFF	OFF	OFF	OFF	ON	OFF	2-3	2-3	2-3
8. P54CT-166 MHz	OFF	ON	ON	OFF	OFF	OFF	ON	OFF	2-3	2-3	2-3
9. P54CTB-166 MHz	OFF	ON	ON	OFF	OFF	OFF	ON	OFF	2-3	2-3	2-3
10. P54CTB-200 MHz	OFF	OFF	ON	OFF	OFF	OFF	ON	OFF	2-3	2-3	2-3
11. AMDK5-PR133	OFF	ON	OFF	OFF	OFF	OFF	ON	OFF	2-3	2-3	2-3
12. AMDK5-PR166	OFF	ON	ON	OFF	OFF	OFF	ON	OFF	2-3	2-3	2-3
13. AMD-K6/166 (2.9V)	OFF	ON	ON	OFF	OFF	ON	ON	OFF	2-3	2-3	2-3
14. AMD-K6/200 (2.9V)	OFF	OFF	ON	OFF	OFF	ON	ON	OFF	2-3	2-3	2-3
15. AMD-K6/233 (3.2V)	OFF	OFF	OFF	ON	OFF	OFF	ON	OFF	2-3	2-3	2-3
16. AMD-K6/266 (66*4 2.2V) AMD-K6-2/266 (66*4 2.2V)	OFF	ON	OFF	OFF	ON	OFF	OFF	ON	2-3	2-3	2-3
17. AMD-K6/250 (100*2.5 2.2V)	OFF	ON	ON	OFF	ON	OFF	OFF	OFF	1-2	1-2	2-3

18. AMD-K6/300 (66*4.5 2.2V)	OFF	ON	ON	OFF	ON	OFF	OFF	ON	2-3	2-3	2-3
19. AMD-K6/300 (100*3 2.2V) AMD-K6-2/300 (100*3 2.2V)	OFF	OFF	ON	OFF	ON	OFF	OFF	OFF	1-2	1-2	2-3
CPU	SW1	SW2	SW3	SW4	SW5	SW6	SW7	SW8	JP7	JP8	JP9
20. AMD-K6-2/333 (95*3.5 2.2V)	ON	OFF	OFF	OFF	ON	OFF	OFF	OFF	1-2	1-2	2-3
21. Cyrix/IBM 6x86-150MHz-PR200+ (75*2)	ON	ON	OFF	OFF	OFF	OFF	ON	OFF	1-2	2-3	2-3
22. Cyrix/IBM 6x86L-PR166+ (2.8V)	OFF	ON	OFF	OFF	OFF	OFF	ON	OFF	2-3	2-3	2-3
23. Cyrix/IBM 6x86MX-PR200+ (75*2 2.9V)	ON	ON	OFF	OFF	OFF	ON	ON	OFF	1-2	2-3	2-3
24. Cyrix/IBM 6x86MX-PR166 (66*2 2.9V)	OFF	ON	OFF	OFF	OFF	ON	ON	OFF	2-3	2-3	2-3
25. Cyrix/IBM 6x86MX-PR200 (66*2.5 2.9V)	OFF	ON	ON	OFF	OFF	ON	ON	OFF	2-3	2-3	2-3
26. Cyrix/IBM 6x86MX-PR200 (75*2 2.9V)	ON	ON	OFF	OFF	OFF	ON	ON	OFF	1-2	2-3	2-3
27. Cyrix/IBM 6x86MX-PR233 (66*3 2.9V)	OFF	OFF	ON	OFF	OFF	ON	ON	OFF	2-3	2-3	2-3
28. Cyrix/IBM 6x86MX-PR233 (75*2.5 2.9V)	ON	ON	ON	OFF	OFF	ON	ON	OFF	1-2	2-3	2-3
29. Cyrix/IBM 6x86MX-PR233 (83*2 2.9V)	OFF	ON	OFF	OFF	OFF	ON	ON	OFF	1-2	2-3	2-3
30. Cyrix/IBM 6x86MX-PR266 (66*3.5 2.9V)	OFF	OFF	OFF	OFF	OFF	ON	ON	OFF	2-3	2-3	2-3
31. Cyrix/IBM 6x86MX-PR266 (75*3 2.9V)	ON	OFF	ON	OFF	OFF	ON	ON	OFF	1-2	2-3	2-3
32. Cyrix/IBM 6x86MX-PR266 (83*2.5 2.9V)	OFF	ON	ON	OFF	OFF	ON	ON	OFF	1-2	2-3	2-3
33. Cyrix M -PR300 (66*3.5 2.9V)	OFF	OFF	OFF	OFF	OFF	ON	ON	OFF	2-3	2-3	2-3
34. IDT C6-200 (66*3 3.52V)	OFF	OFF	ON	OFF	OFF	OFF	ON	OFF	2-3	2-3	2-3

35. IDT C6-225 (75*3 3.52V)	ON	OFF	ON	OFF	OFF	OFF	ON	OFF	1-2	2-3	2-3
36. IDT C6-266 (66*4 3.52V)	OFF	ON	OFF	OFF	OFF	OFF	ON	ON	2-3	2-3	2-3

★ Note: If Cyrix 6x86 is being used, please check the CPU Date Code after 605.

1. Pentium® Processor 100 MHz

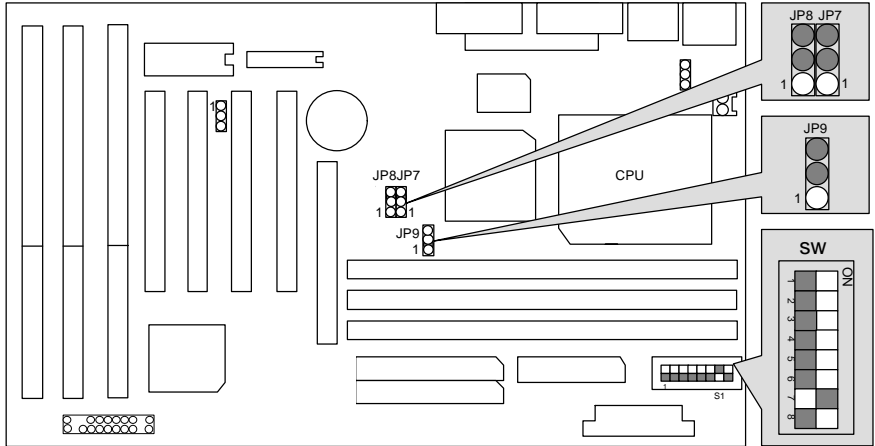

2. Pentium® Processor 133 MHz

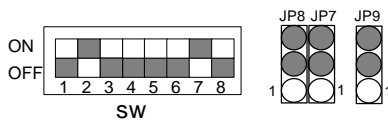

3. Pentium® Processor 166 MHz

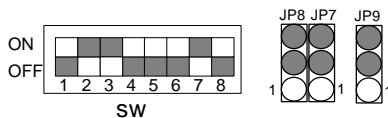

4. Pentium® Processor 200 MHz

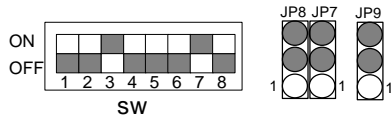

5. Intel MMX-166 MHz

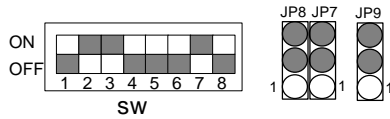

6. Intel MMX-200 MHz

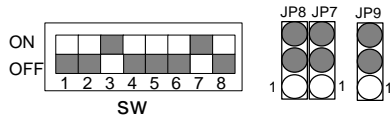

7. Intel MMX-233 MHz

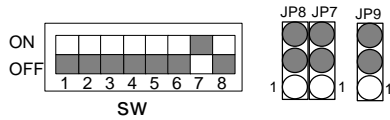

8. P54CT-166 MHz

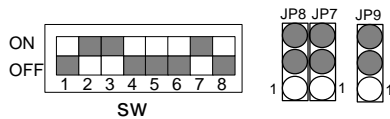

9. P54CTB-166 MHz

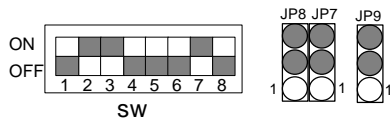

10. P54CTB-200 MHz

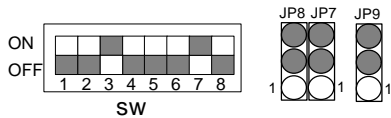

11. AMDK5-PR133

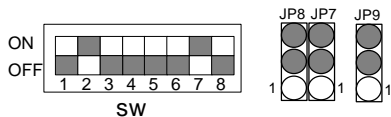

12. AMDK5-PR166

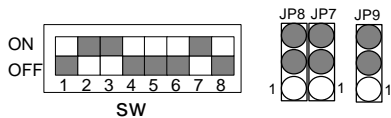

13. AMD-K6/166 (2.9V)

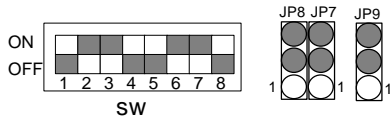

14. AMD-K6/200 (2.9V)

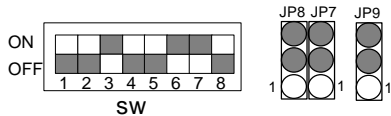

15. AMD-K6/233 (3.2V)

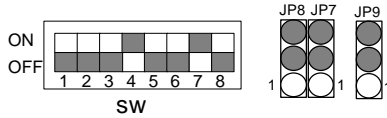

16. AMD-K6/266 (2.2V 66*4); AMD-K6-2 266 (2.2V 66*4)

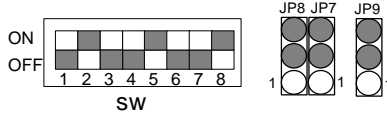

17. AMD-K6/250 (2.2V 100*2.5)

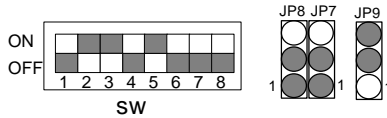

18. AMD-K6/300 (2.2V 66*4.5)

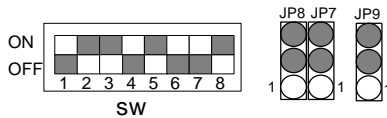

19. AMD-K6/300 (2.2V 100*3); AMD-K6-2 300 (2.2V 100*3)

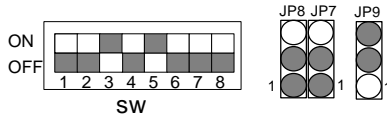

20. AMD-K6/333 (95*3.5 2.2V)

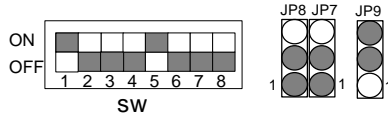

21. Cyrix / IBM 6x86-150 MHz-PR200+ (75*2)

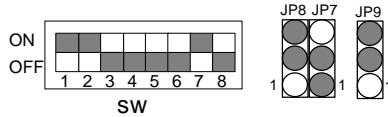

22. Cyrix / IBM 6x86L-PR166+ (2.8V)

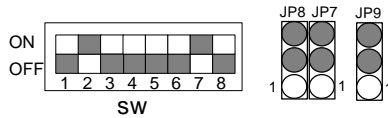

23. Cyrix / IBM 6x86L-PR200+ (75*2 2.9V)

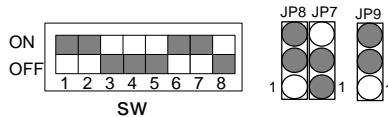

24. Cyrix / IBM 6x86MX-PR166 (66x2 2.9V)

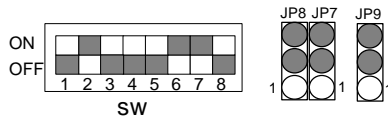

25. Cyrix / IBM 6x86MX-PR200 (66x2.5 2.9V)

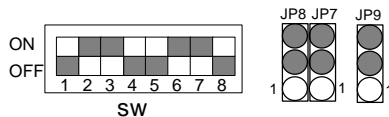

26. Cyrix / IBM 6x86MX-PR200 (75x2 2.9V)

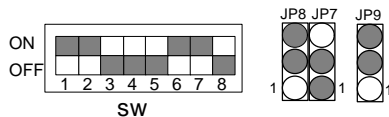

27. Cyrix / IBM 6x86MX-PR200 (66x3 2.9V)

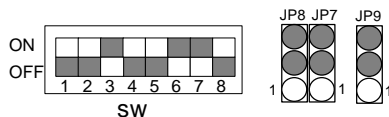

28. Cyrix / IBM 6x86MX-PR233 (75x2.5 2.9V)

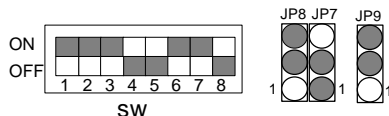

29. Cyrix / IBM 6x86MX-PR233 (83x2 2.9V)

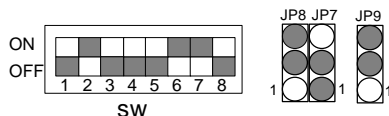

30. Cyrix / IBM 6x86MX-PR266 (66x3.5 2.9V)

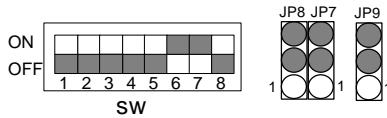

31. Cyrix / IBM 6x86MX-PR266 (75x3 2.9V)

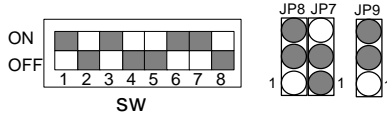

32. Cyrix / IBM 6x86MX-PR266 (83x2.5 2.9V)

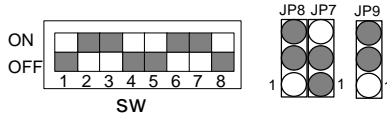

33. Cyrix M2-PR300 (66x3.5 2.9V)

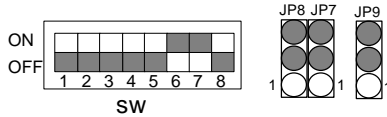

34. IDT C6-200 (66x3 3.52V)

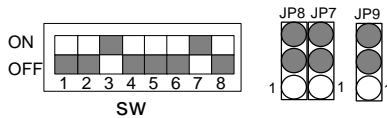

35. IDT C6-225 (75x3 3.52V)

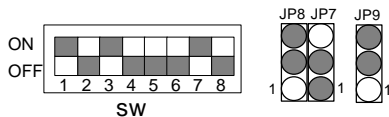

36. IDT C6-266 (66x4 3.52V)

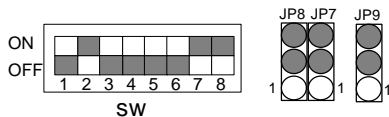

III. Quick Installation Guide of Jumper setting:

SPK : Speaker Connector

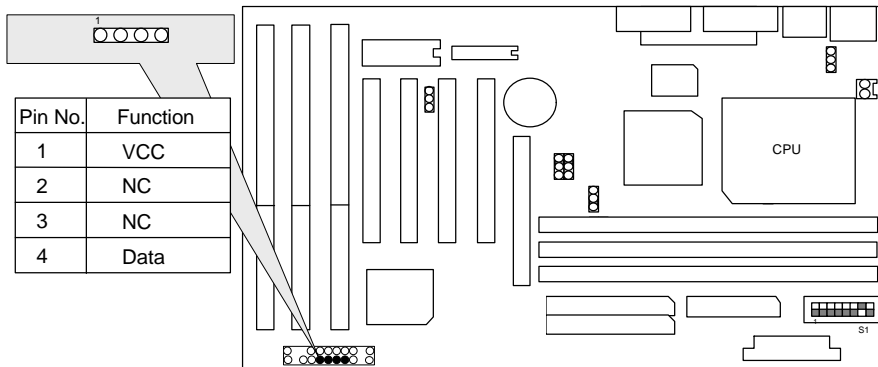

RST : Reset Switch

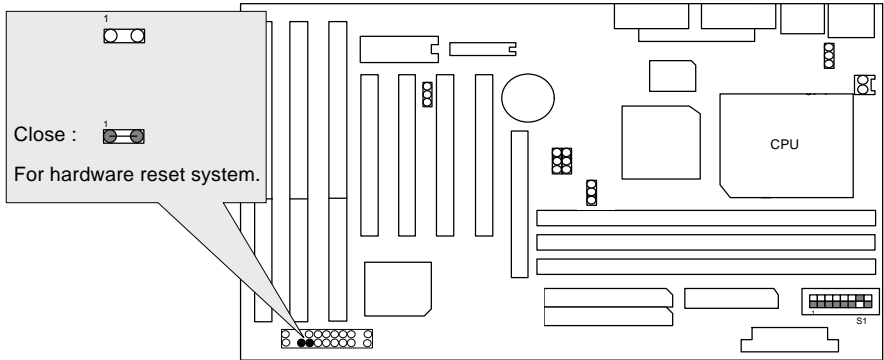

PWR LED : Power LED (As a 3 steps ACPI LED)

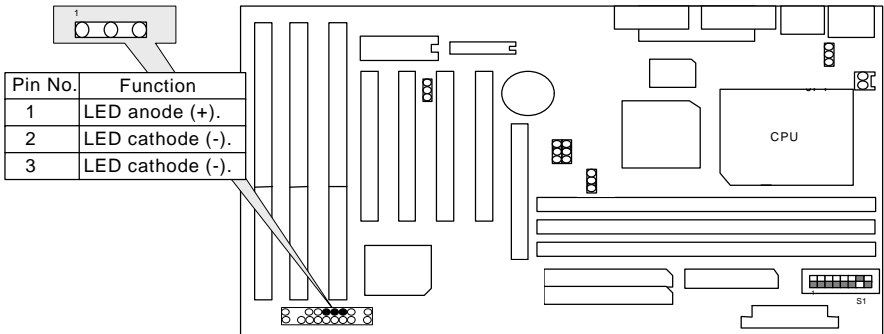

HD : IDE Hard Disk Active LED

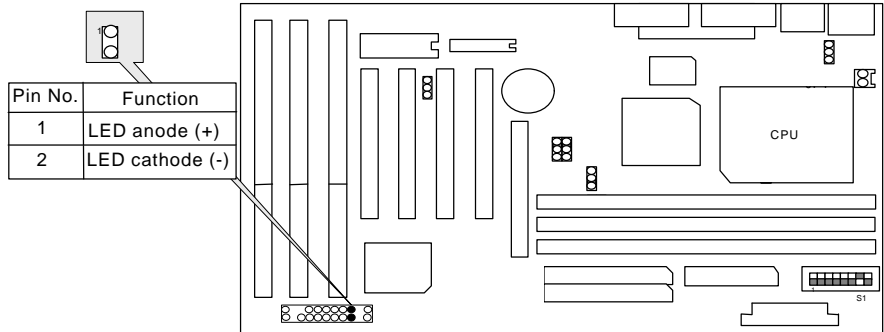

GN : Green Function Switch

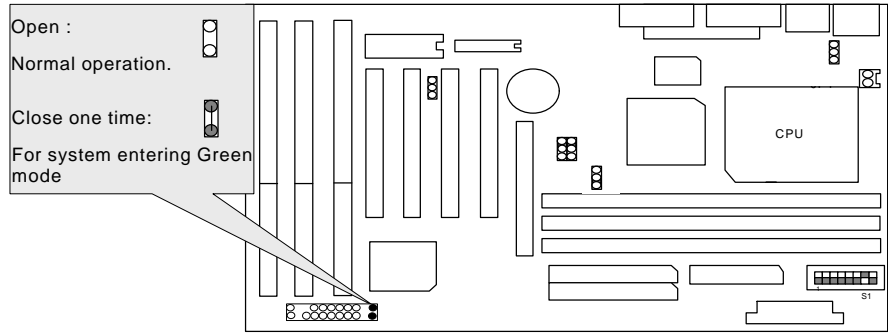

GD : Green LED

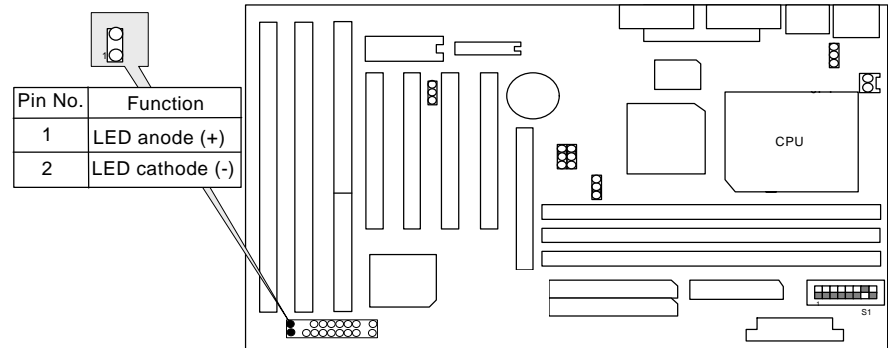

SOFT PWR : Power On/Off Switch

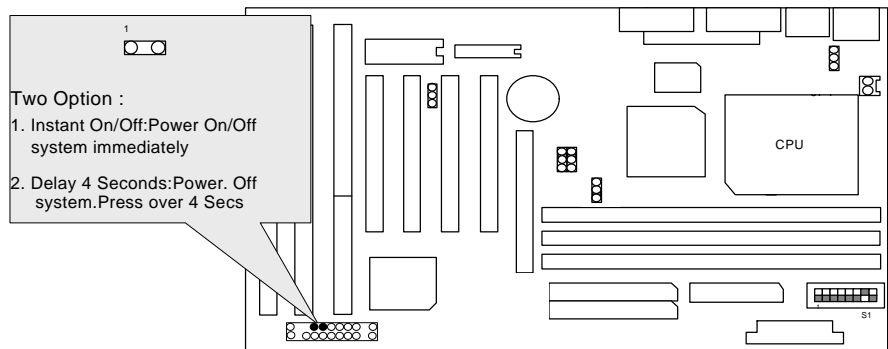

ATX Power Connector

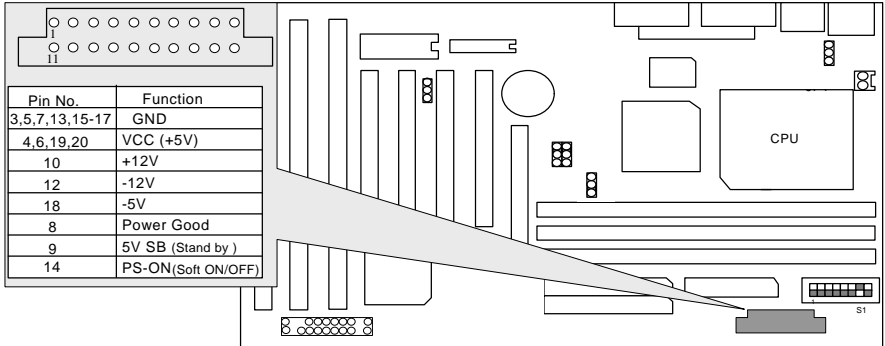

JP1 : CPU Cooling Fan Power Connector

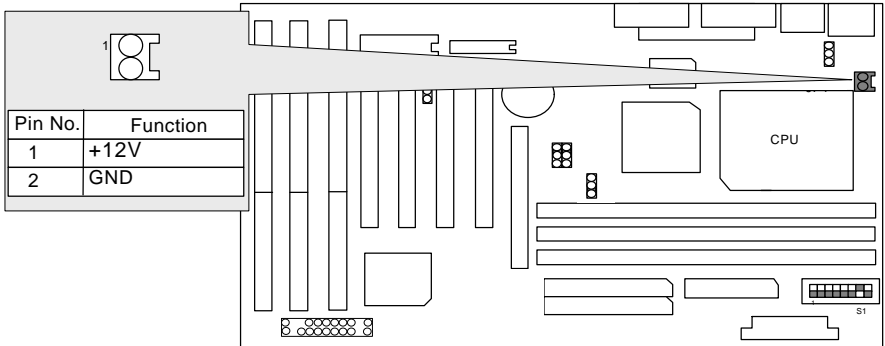

JP5: Wake On Lan

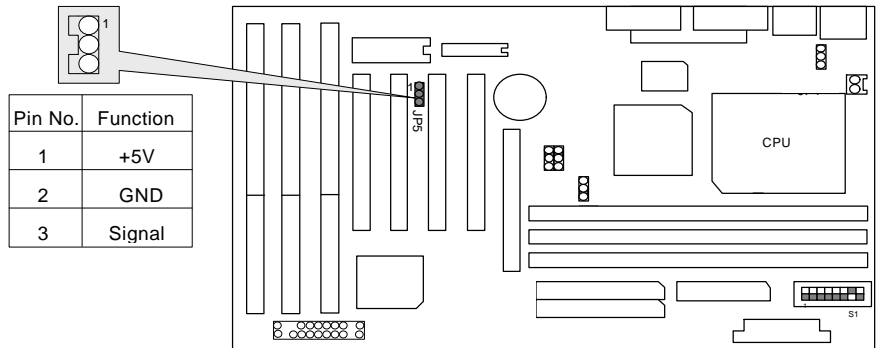

LPT : LPT PORT

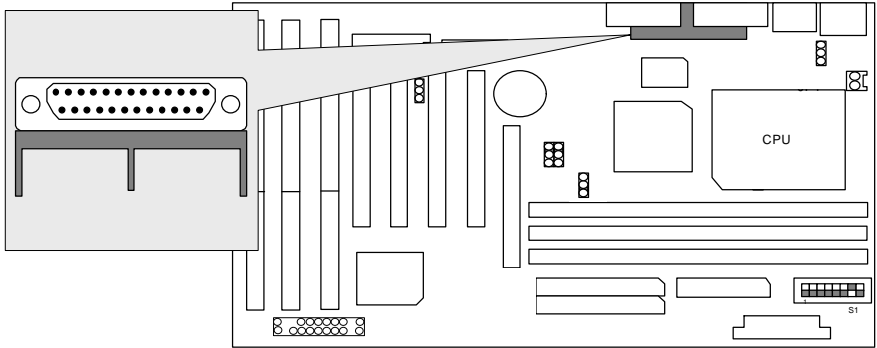

USB: USB Port

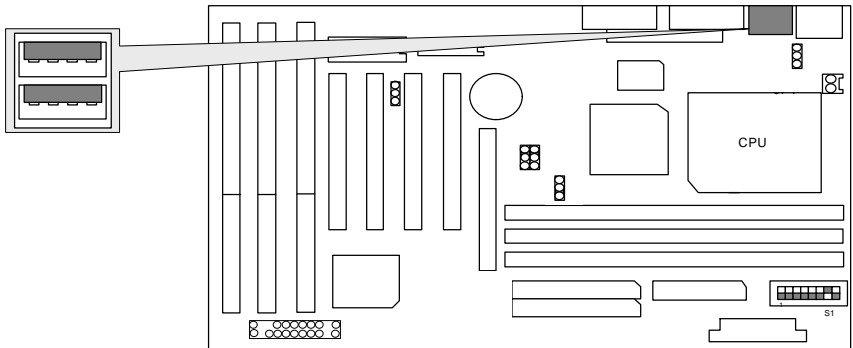

COM B : COM B PORT

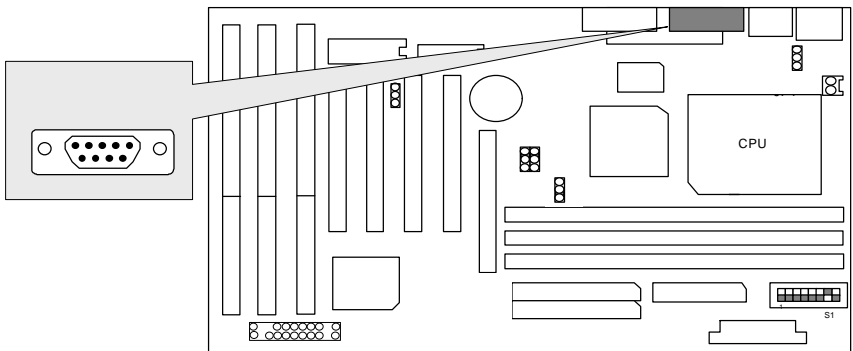

COM A : COM A PORT

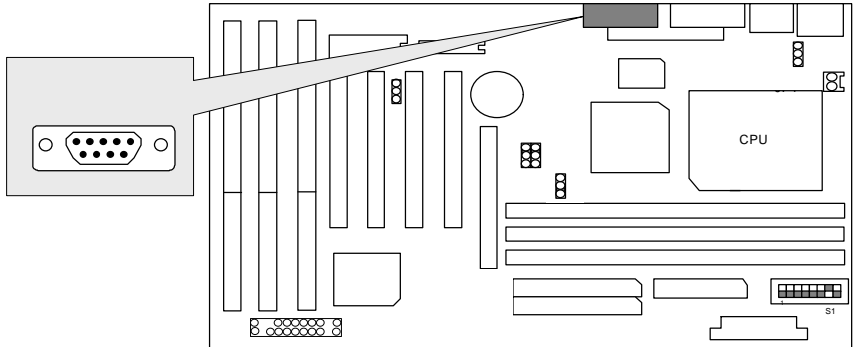

M.S. / K.B. : PS/2 Mouse / Keyboard Connector

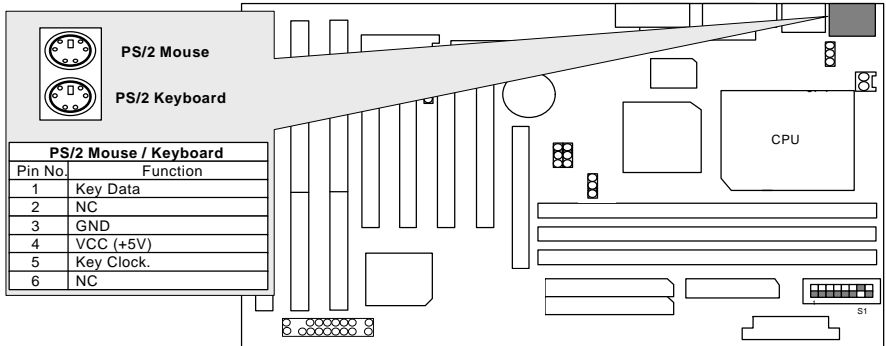

FLOPPY : FLOPPY PORT

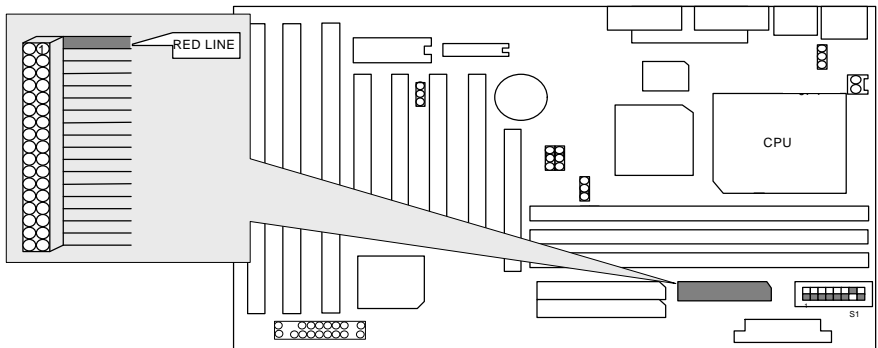

IDE1 : For Primary IDE port

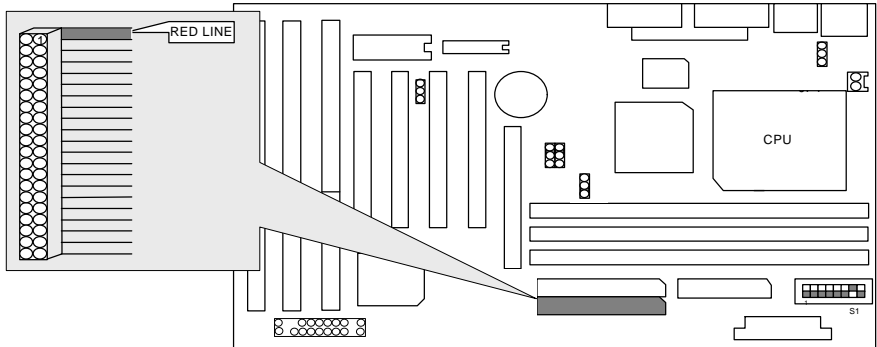

IDE2 : For Secondary IDE port

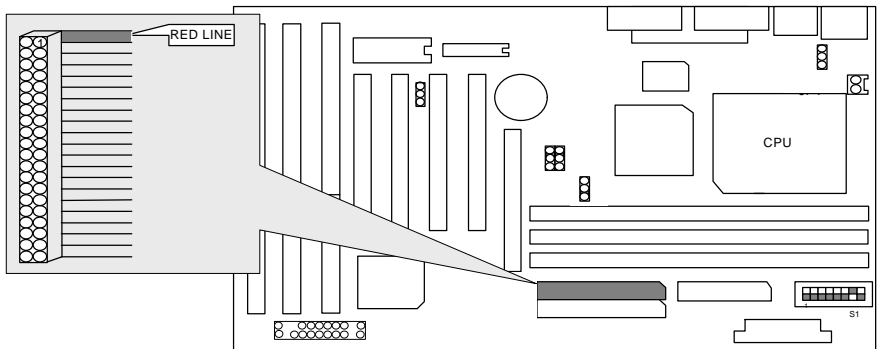

BT1 : For Battery

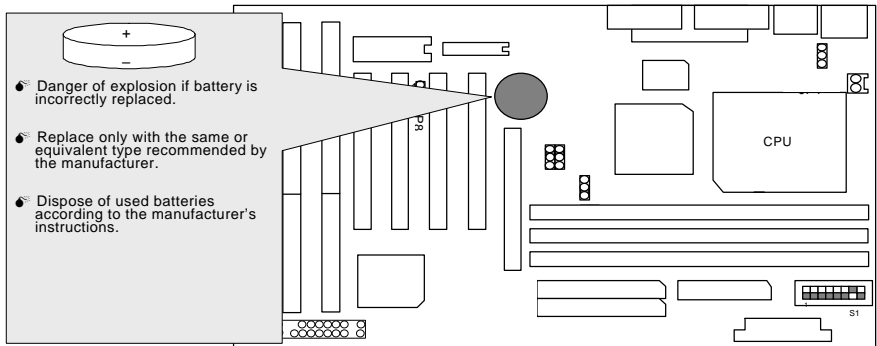

JP3 : Keyboard Power On/Off

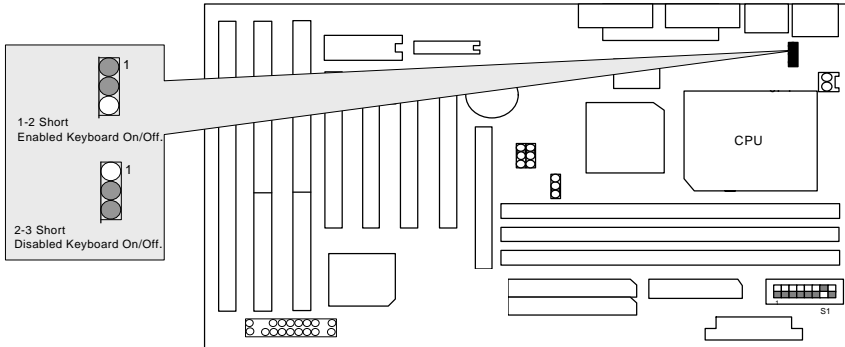

III. Top Performance Test Setting:

Users have to modify the value for each item in chipset features as follow

```
ROM PCI/ISA BIOS (2A5KK609)
CHIPSET FEATURES SETUP
AWARD SOFTWARE, INC.

Auto Configuration           : Enabled
Host Read DRAM Command Mode : Bypass
AT Bus Clock                 : CLK2/4
DRAM Timing                  : Fast
SDRAM CAS Latency            : 2
Pipelined Function           : Enabled
Graphics Aperture Size       : 64 MB
SDRAM Burst X-1-1-1-1-1-1   : Enabled
DRAM Data Integrity Mode     : Disabled
Memory Hole At 15-16M        : Disabled
ISA Line Buffer               : Enabled
Passive Release              : Enabled
Delay Transaction            : Disabled
Primary Frame Buffer          : 2 MB
VGA Frame Buffer              : Enabled
Data Merge                   : Enabled

Auto Detect DIMM/PCI Clk    : Enabled
Spread Spectrum              : Disabled

ESC : Quit           ↑++ : Select Item
F1  : Help           PU/PD/+/- : Modify
F5  : Old Values    (Shift)F2 : Color
F6  : Load BIOS Defaults
F7  : Load Setup Defaults
```

for top performance setting.

** Each value of items as above depends on your hardware configuration : CPU , SDRAM , Cards , etc.

Please modify each value of items If your system does not work properly.

PERFORMANCE LIST

The following list of performance data is the testing results of some popular benchmark testing programs.

These data are just referred by users, and there is no responsibility for different testing data values gotten by users. (The different Hardware & Software configuration will result in different benchmark testing results.)

- CPU Pentium® Processor MMX-233 MHz , Cyrix 6x86M2-PR300 , AMD K6-2 300
- DRAM (128 x 1) MB SDRAM (LGS GM72N66841CT7J)
- CACHE SIZE 512 KB
- DISPLAY GA-600 (4MB SGRAM)
- STORAGE Onboard IDE (IBM DHEA-36451)
- O.S. Windows® NT 4.0
- DRIVER Display Driver at 1024 x 768 x 256 colors x 75Hz.
ALi Bus Master IDE Driver

Processor	Intel-MMX 233MHz (66x3.5)	AMD K6-2 300 (100x3)	Cyrix M-2 PR300 (66x3.5)
Winbench98 CPU mark32	467	756	478
FPU Winmark	912	979	534
Business Disk	1760	1840	1820
Hi-End Disk	4160	4550	4450
Business Graphics	105	153	139
Hi-End Graphics	109	156	150
Winstone98 Business	22.5	29.1	25.9
Hi-End	23.8	29.6	26.7

TABLE OF CONTENTS

1. INTRODUCTION

1.1. PREFACE	1-1
1.2. KEY FEATURES	1-1
1.3. PERFORMANCE LIST	1-3
1.4. BLOCK DIAGRAM.....	1-4
1.5. INTRODUCE THE PCI - BUS	1-5
1.6. FEATURES	1-5
1.7. What is AGP	1-6

2. SPECIFICATION

2.1. HARDWARE	2-1
2.2. SOFTWARE.....	2-2
2.3. ENVIRONMENT	2-2

3. HARDWARE INSTALLATION

3.1. UNPACKING	3-1
3.2. MAINBOARD LAYOUT.....	3-2
3.3. QUICK REFERENCE FOR JUMPERS & CONNECTORS	3-2
3.4. SRAM INSTALLATION DRAM INSTALLATION.....	3-4
3.5. DRAM INSTALLATION.....	3-5
3.6. CPU INSTALLATION AND JUMPERS SETUP.....	3-5
3.7. CMOS RTC & ISA CFG CMOS SRAM.....	3-7
3.8. SPEAKER CONNECTOR INSTALLATION.....	3-8
3.9. ACPI LED CONNECTOR INSTALLATION	3-8
3.10. HARDWARE RESET SWITCH CONNECTOR INSTALLATION.....	3-8

3.11. GREEN FUNCTION INSTALLATION	3-8
3.12. PERIPHERAL DEVICE INSTALLATION.....	3-8
4. BIOS CONFIGURATION	
4.1. ENTERING SETUP	4-1
4.2. CONTROL KEYS	4-2
4.3. GETTING HELP	4-3
4.3.1. Main Menu.....	4-3
4.3.2. Status Page Setup Menu / Option Page Setup Menu	4-3
4.4. THE MAIN MENU	4-3
4.5. STANDARD CMOS SETUP MENU	4-5
4.6. BIOS FEATURES SETUP	4-10
4.7. CHIPSET FEATURES SETUP	4-14
4.8. POWER MANAGEMENT SETUP	4-17
4.9. PNP/PCI CONFIGURATION.....	4-21
4.10. LOAD BIOS DEFAULTS	4-25
4.11. LOAD SETUP DEFAULTS.....	4-26
4.12. INTEGRATED PERIPHERALS	4-27
4.13. SUPERVISOR / USER PASSWORD	4-33
4.14. IDE HDD AUTO DETECTION.....	4-34
4.15. SAVE & EXIT SETUP	4-35
4.16. EXIT WITHOUT SAVING	4-36
A.Troubleshooting	5-1

1. INTRODUCTION

1.1. PREFACE

Welcome to use the **5AX** motherboard. The motherboard is a Pipeline 512 KB CACHE Pentium® Processor based PC / AT compatible system with ISA bus and PCI Local Bus, and has been designed to be the fastest PC / AT system. There are some new features allow you to operate the system with the performance you want.

This manual also explains how to install the motherboard for operation, and how to set up your CMOS CONFIGURATION with BIOS SETUP program.

1.2. KEY FEATURES

- ❑ Pentium® Processor based PC / AT compatible mainboard with PCI / ISA / AGP Bus.
- ❑ 4 PCI Bus slots, 3 ISA Bus slots, 1 AGP slot.
- ❑ Supports :
 - Pentium® Processor :100-200 MHz; P54CT (166); MMX (166 / 200 / 233), P54CTB (166 / 200)
 - AMD :K5-(PR133 / PR166); K6-(166 / 200(2.9V) / 233(3.2V)/266/300(2.2V); K6-2(266/300/333 (95*3.5)(2.2V))
 - Cyrix/IBM :6x86(133(PR166+));6x86L(133PR166+(2.8V)) ; 6x86MX (PR200 (66x2.5(2.9V) / (75x2(2.9V) / PR233 (66x3(2.9V) / (75x2.5 2.9V)) / PR266 (66x3.5 2.9V) (75x3 2.9V) (83x2.5 2.9V)); M -PR300(66x3.5 2.9V)
 - IDT :C6-(200; 225; 266)
- ❑ Supports true 64 bits CACHE and DRAM access mode.
- ❑ Supports 321 Pins (Socket 7) ZIF white socket on board.
- ❑ Supports 512 KB Pipeline Burst Sync. 2nd Level Cache.

- ❑ CPU L1 / L2 Write-Back cache operation.
- ❑ Supports 8 - 768 MB DRAM memory on board.
- ❑ Supports 3*168 pin 64/72 Bit DIMM module.
- ❑ Supports 2-channel Enhanced PCI IDE ports for 4 IDE Devices.
- ❑ Supports 2*COM (16550), 1*LPT (EPP / ECP), 1*1.44MB Floppy port.
- ❑ Supports Green function, Plug & Play function.
- ❑ Licensed AWARD BIOS, FLASH RAM for BIOS update.
- ❑ 30.5cm*17cm, ATX Form factor.
- ❑ Supports USB port & PS/2 Mouse and K/B port.
- ❑ Supports Keyboard Power On/Off.
- ❑ Supports 3 steps ACPI LED.

1.3. PERFORMANCE LIST

The following list of performance data is the testing results of some popular benchmark testing programs.

These data are just referred by users, and there is no responsibility for different testing data values gotten by users. (The different Hardware & Software configuration will result in different benchmark testing results.)

- CPU Pentium® Processor MMX-233 MHz , Cyrix 6x86M2-PR300 , AMD K6-2 300
- DRAM (128 × 1) MB SDRAM (LGS GM72N66841CT7J)
- CACHE SIZE 512 KB
- DISPLAY GA-600 (4MB SGRAM)
- STORAGE Onboard IDE (IBM DHEA-36451)
- O.S. Windows® NT 4.0
- DRIVER Display Driver at 1024 x 768 x 256 colors x 75Hz.
ALi Bus Master IDE Driver

Processor	Intel-MMX 233MHz (66x3.5)	AMD K6-2 300 (100x3)	Cyrix M-2 PR300 (66x3.5)
Winbench98 CPU mark32	467	756	478
FPU Winmark	912	979	534
Business Disk	1760	1840	1820
Hi-End Disk	4160	4550	4450
Business Graphics	105	153	139
Hi-End Graphics	109	156	150
Winstone98 Business	22.5	29.1	25.9
Hi-End	23.8	29.6	26.7

1.4. BLOCK DIAGRAM

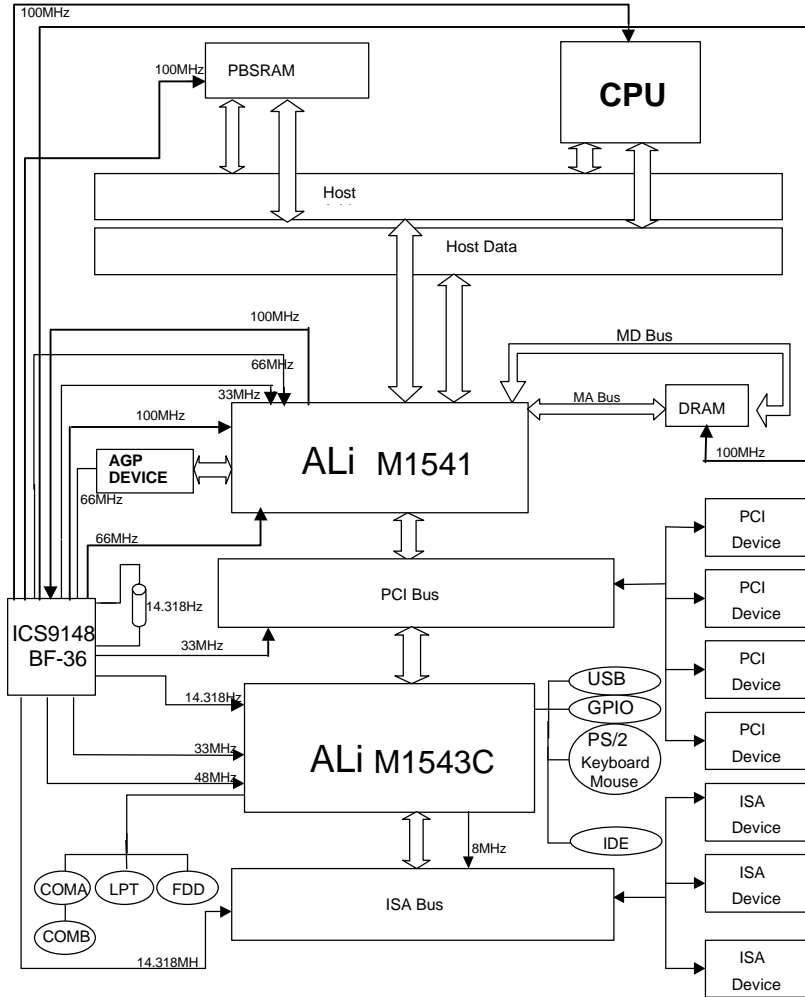

1.5. INTRODUCE THE PCI - BUS

Connecting devices to a CPU local bus can dramatically increase the speed of I/O-bound peripherals with only a slight increase in cost over traditional systems.

This price / Performance point has created a vast market potential for local bus products.

The main barrier to this market has been the lack of an accepted standard for local bus peripherals.

Many mainboard and chipset manufactures developed their own local bus implementations, but they are incompatible with each other.

The VL (Video Electronics Standards Association) local bus and PCI (Peripheral Component Interconnect) bus specification was created to end this confusion.

The PCI - bus standard, under development since Jun. 1992, which is designed to bring workstation-level performance to standard PC platform. The PCI - bus removes many of the bottlenecks that have hampered PC for several years.

On the PCI - bus, peripherals operate at the native speed of the computer system, thus enabling data transfer between peripherals and the system at maximum speed.

This performance is critical for bandwidth-constrained devices such as video, multimedia, mass storage, and networking adapters.

PCI - bus standard provides end-users with a low-cost, extendible and portable local bus design, which will allow system and peripherals from different manufactures to work together.

1.6. FEATURES

- ❑ 32 bits bus transfer mode.
- ❑ Bus Master or Slave access.
- ❑ Memory burst transfer to 132 MB/sec.
- ❑ 33 MHz operation speed.
- ❑ 10 device loading ability.
- ❑ CPU independent.

1.7. What is AGP

The Accelerated Graphics Port (AGP) is a new port on the Host-To-PCI bridge device that supports an AGP port. The main purpose of the AGP port is to provide fast access to system memory.

The AGP port can be used either as fast PCI port (32-bits at 66MHz vs. 32-bits at 33MHz) or as an AGP port which supports 2x data-rate, a read queue, and side band addressing. When the 2x-data rate is used the port can transmit data at 533Mb/sec ($66.6 \times 2 \times 4$). The read-queue can be used to pipeline reads – removing the effects of the reads-latency. Side band addressing can be used to transmit the data address on a separate line in order to further speed the transaction.

2. SPECIFICATION

2.1. HARDWARE

- CPU
 - Pentium® Processor 100 - 200 MHz, MMX, P54CT, P54CTB, AMDK5(PR133 / PR166), AMD-K6 (166 / 200 (2.9V) / 233 (3.2V) / 266 (2.2V) / 300 (2.2V)), AMD-K6-2 (266 / 300 /333 (95*3.5)(2.2V)), Cyrix / IBM 6x86 (PR166+ / PR200+), Cyrix / IBM 6x86L (PR166+ / PR200+(2.8V)), Cyrix / IBM 6x86MX (PR200 (66x2.5 2.9V) (75x2 2.9V) / PR233 (66x3 2.9V) (75x2.5 2.9V) (83x2) / PR266 (66x3.5) (75x3) (83x2.5), Cyrix M (300(2.9V)), IDT C6-(200, 225, 266)
 - 321 pins (socket 7) ZIF white socket on board.
 - 3.52V / 2.0V-3.5V Dual Power Ready.
- COPROCESSOR
 - Included in processor.
- SPEED
 - 66 / 75 / 83 / 95 /100MHz system speed.
 - 66 MHz AGP-Bus speed.
 - 33 MHz PCI-Bus speed.
 - 8 MHz AT bus speed.
- DRAM MEMORY
 - 3 banks 168 pins DIMM module socket on board.
 - Use 8 / 16 / 32 / 64 / 128 / 256 MB 50~60 ns DIMM module DRAM.
 - 8 ~ 768 MB DRAM size.
 - Supports 3.3V SDRAM / EDO type DRAM.
 - Supports ECC or Non-ECC type DRAM.
- CACHE MEMORY
 - 16 / 24 / 32 / 64KB L1cache included in CPU.
 - 512 KB 2nd Level cache on board.
 - Supports Write Back cache function for both CPU & on board cache.
- I/O BUS SLOTS
 - 4 xMaster / Slave PCI-BUS Slots.
 - 3 x16 bits ISA BUS Slots.
 - 1 xAGP Slot.

- IDE PORTS
 - 2-channel Enhanced IDE port on board.(Using IRQ14,15)
 - Supports Mode 3,4 IDE & ATAPI CD – ROM.
- I/O PORTS
 - Supports 2 x16550 COM ports. (Using IRQ4, 3)
 - Supports 1 x EPP/ECP LPT port. (Using IRQ7 or 5 and DMA3 or 1)
 - Supports 1 x 1.44/2.88 MB Floppy port. (Using DMA2 & IRQ6)
 - Supports PS/2 Mouse. (Using IRQ12)
- GREEN FUNCTION
 - Suspend mode support.
 - Green switch & ACPI LED support.
 - IDE & Display power down support.
 - Monitor all IRQ / DMA / Display / I/O events.
- BIOS
 - 1Mbit FLASH RAM.
 - Supports Plug & Play Function.
- DIMENSION
 - ATX Form Factor, 4 layers PCB.

2.2. SOFTWARE

- BIOS
 - Licensed AWARD BIOS.
 - AT CMOS Setup, BIOS / Chipset Setup, Green Setup, Hard Disk Utility included.
- O.S.
 - Operation with MS-DOS[®], Windows[®]95, WINDOWS[™] NT, OS/2, NOVELL and SCO UNIX.

2.3. ENVIRONMENT

- Ambient Temp.
 - 0°C to +50°C (Operating).
- Relative Hum.
 - 0 to +85% (Operating).
- Altitude
 - 0 to 10,000 feet (Operating).
- Vibration
 - 0 to 1,000 Hz.
- Electricity
 - 4.9 V to 5.2 V.
 - Max. 20A current at 5V.

3. HARDWARE INSTALLATION

3.1. UNPACKING

The mainboard package should contain the following:

- The **5AX** mainboard.
- USER'S MANUAL for mainboard.
- Cable set for IDE Floppy.
- Diskette for Mainboard Utility.

The mainboard contains sensitive electric components which can be easily damaged by static electricity, so the mainboard should be left in its original packing until it is installed.

Unpacking and installation should be done on a grounded anti-static mat.

The operator should be wearing an anti static wristband, grounded at the same point as the anti-static mat.

Inspect the mainboard carton for obvious damage. Shipping and handling may cause damage to your board. Be sure there are no shipping and handling damage on the board before proceeding.

After opening the mainboard carton, extract the system board and place it only on a grounded anti-static surface component side up. Again inspect the board for damage.

Press down on all of the socket IC's to make sure that they are properly seated. Do this only on with the board placed on a firm flat surface.

DO NOT APPLY POWER TO THE BOARD IF IT HAS BEEN DAMAGED.

It is assumed that the chassis is designed for a standard ATX mainboard mounting. Place the chassis on the anti-static mat and remove the cover.

Take the plastic clips, Nylon stand-off and screws for mounting the system board, and keep them separate.

3.2. MAINBOARD LAYOUT

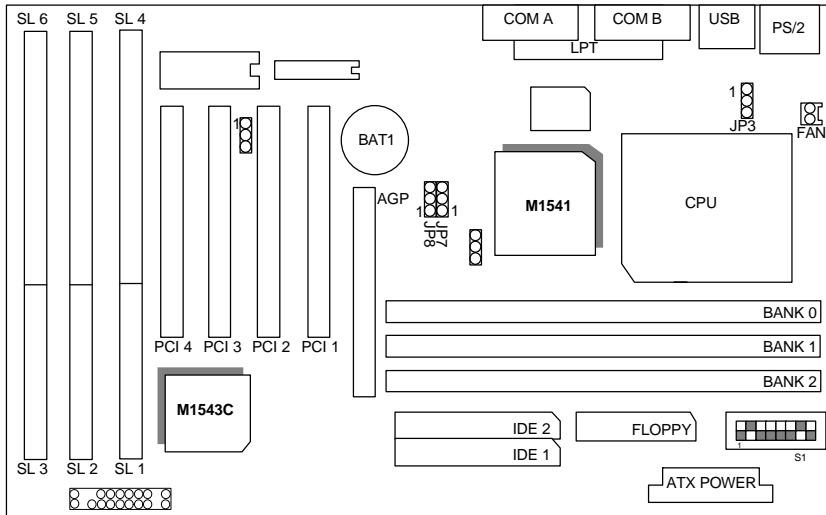
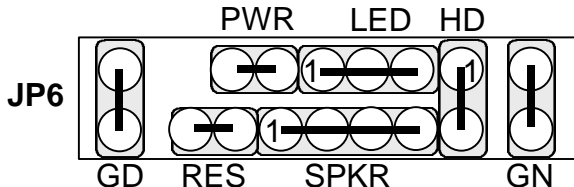

Figure 3.1

3.3. QUICK REFERENCE FOR JUMPERS & CONNECTORS

◆ I/O Port Connectors	
IDE 1	For Primary IDE port.
IDE 2	For Secondary IDE port.
FLOPPY	For Floppy port.
USB	For USB port.
COM B	For Serial port2 (COM B){Support Modem Ring On}.
COM A	For Serial port1 (COM A).
LPT	For LPT port.
PS/2	For PS/2 Mouse & Keyboard Connector.
ATX PWR	For ATX Power Connector.

JP6 : 2*11 PIN Jumper



PWR: Soft Power Connector



On – Off : For POWER ON or Suspend IN / OUT.
 On 4 sec : For POWER OFF before VGA Enable or CMOS setup select “delay 4sec.” for POWER OFF mode.

RES: Reset Switch



Open: Normal Operation
 Short: For Hardware Reset System

LED: Power LED



PIN 1: anode (+)
 PIN 2: cathode (-)
 PIN 3: cathode (-)

SPKR: Speaker Connector



PIN 1: VCC
 PIN 2: NC
 PIN 3: NC
 PIN 4: Data

HD: IDE Hard Disk Active LED



PIN 1: LED anode (+)
 PIN 2: LED cathode (-)

GN: Green Switch



Open: Normal operation
Short: Entering Green Mode

GD: Green Function Active LED



PIN 1: LED anode (+)
PIN 2: LED cathode (-)

◆ JP5: Wake on Lan	
Pin No.	Function
1	+5V SB
2	GND
3	Signal

◆ FAN: CPU cooling FAN Power Connector	
Pin No.	Function
1	GND.
2	+12V
3	SENSE

◆ JP3: Keyboard Power On/Off Connector	
Pin No.	Function
1,2 Close	Enabled Keyboard power on/off.
2,3 Close	Disabled Keyboard power on/off.

3.4. SRAM INSTALLATION

Sync. SRAM (Pipeline Burst SRAM)

If Sync SRAM Chip is installed, it consists of Pipeline Burst 1 Pc 64 K x 64 512KByte.

3.5. DRAM INSTALLATION

The mainboard can be installed with 8 / 16 / 32 / 64 / 128 / 256 MB 168 pins DIMM module DRAM, and the DRAM speed must be 67~100 MHz for SDRAM. The DRAM memory system on mainboard consists of bank 0, 1 & bank 2.

Because the 168 pins DIMM module is 64 bits width, using 1 PCS which can match a 64 bits system. The total memory size is 8 MB ~ 768 MB DRAM. The DRAM installation position refer to Figure 3.1, and notice the Pin 1 of DIMM module must match with the Pin 1 of DIMM socket. Insert the DRAM DIMM module into the DIMM socket at Vertical angle. If there is a wrong direction of Pin 1, the DRAM DIMM module couldn't be inserted into socket completely.

3.6. CPU INSTALLATION AND JUMPERS SETUP

The system speed depends on the frequency of CLOCK GENERATOR. The user can change SW selection to set up the system speed to 66 / 75 / 83 / 95 / 100MHz for 3.3V/2.5V Pentium[®] Processor (100-200 MHz) / AMDK5(PR133 / PR166) / AMD-K6(166/200(2.9V)/233(3.2V)/266/300(2.2V)) / AMD-K6-2(266/300/333(95*3.5)(2.2V)), Cyrix / IBM 6x86 (PR166+/PR200+), Cyrix / IBM 6x86L (PR166+/PR200+ (2.8V)), Cyrix / IBM 6x86MX (PR200 (66x2.5 2.9V) (75x2 2.9V)/ PR233 (66x3 2.9V) (75x2.5 2.9V) / PR266 (66x3.5 2.9V) (75x3 2.9V) (83x2.5 2.9V)), Cyrix M -PR300 (66*3.5 2.9V); IDT C6-200(66*3) / 225(75*3) / 266(66*4).

The mainboard can use Pentium[®] Processor, P54CT, MMX or P54CTB, AMDK5, AMD-K6, AMD-K6-2, Cyrix / IBM 6x86, Cyrix M , IDT C6 CPU, and the CPU speed must match with the frequency of CLOCK GEN. It will cause system hanging up if the CLOCK GEN.'S frequency is faster than CPU's.

- ☛ **The CPU is a sensitive electric component and it can be easily damaged by static electricity, so users must keep it away from metal surface when the CPU is installed onto mainboard.**
- ☛ **When the user installs the CPU on socket, please notice that the PIN 1 of CPU is in the same corner as the PIN 1 of socket!**
- ☛ **Before the CPU is installed, the mainboard must be placed on a flat**

plane in order to avoid being broken by the pressure of CPU installation.

◆ SW: CPU INT./ EXT. FREQ. RATIO

O	ON
X	OFF

SW	2	3	8
x 1.5	X	X	X
x 2	O	X	X
x 2.5	O	O	X
x 3	X	O	X
x 3.5	X	X	X
x 4	O	X	O
x 4.5	O	O	O
x 5	X	O	O
x 5.5	X	X	O

SW	4	5	6	7
AUTO	X	X	X	O
2.0 V	X	X	X	X
2.1 V	X	X	O	X
2.2 V	X	O	X	X
2.3 V	X	O	O	X
2.4 V	O	X	X	X
2.5 V	O	X	O	X
2.6 V	O	O	X	X
2.7 V	O	O	O	X
2.8 V	X	X	X	O
2.9 V	X	X	O	O
3.0 V	X	O	X	O
3.1 V	X	O	O	O
3.2 V	O	X	X	O
3.3 V	O	X	O	O
3.4 V	O	O	X	O
3.5 V	O	O	O	O

CPU	AGP	SW1	JP7	JP8	JP9
100	66	OFF	1-2	1-2	2-3
95	63	ON	1-2	1-2	2-3
83	66	OFF	1-2	2-3	2-3
75	75	OFF	2-3	1-2	2-3
75	60	ON	1-2	2-3	2-3
66	66	OFF	2-3	2-3	2-3

★ Note: If Cyrix 6x86 is being used, please check the CPU Date Code after 605.

★ Note: If you want to run 75, 83, 95 or 100MHz in your system properly, it depends on your hardware configurations: CPU, SDRAM, Cards, etc.

3.7. CMOS RTC & ISA CFG CMOS SRAM

Built-in Real Time Clock (RTC) With 256B CMOS SRAM in M5819.

3.8. SPEAKER CONNECTOR INSTALLATION

There is a speaker in AT system for sound purpose. The 4 - Pins connector **SPKR** is used to connect speaker. The speaker can work well in both direction of connector when it is installed to the connector **SPKR** on mainboard.

3.9. ACPI LED CONNECTOR INSTALLATION

This mainboard uses the existing power LED as ACPI LED .The ACPI LED will light on when system is power-on .The ACPI LED is off when the system is power-off. The ACPI LED will blink when system is in Green mode.This connector should be installed to ACPI LED jumper of the mainboard in correct direction.

3.10. HARDWARE RESET SWITCH CONNECTOR INSTALLATION

The RESET switch on panel provides users with HARDWARE RESET function which is almost the same as power-on/off. The system will do a cold start after the RESET switch is pushed and released by user. The RESET switch is a 2 PIN connector and should be installed to **RES** on mainboard.

3.11. GREEN FUNCTION INSTALLATION

There is one jumper for the purpose of power saving, **GN**, to indicate the power saving function . This mainboard uses the existing power LED as ACPI LED . If the ACPI LED is blinking, the system is in green mode. The **GN** switch will force the system into green mode .

3.12. PERIPHERAL DEVICE INSTALLATION

After installation of the device and setup of the jumpers, the mainboard can be mounted into the case and fixed by screw. To complete the mainboard installation, the peripheral devices could be installed now. The basic system needs a display interface card and a storage device.

If a PCI - Bus device is to be installed in the system, any one of three PCI - Bus slots can be used for Slave or Master PCI - Bus device.

After installing the peripheral device, the user should check everything again and prepare to power-on the system.

4. BIOS CONFIGURATION

Award's BIOS ROM has a built-in Setup program that allows users to modify the basic system configuration.

This type of information is stored in battery-backed CMOS SRAM so that it retains the Setup information when the power is turned off.

4.1. ENTERING SETUP

Power ON the computer and press immediately will allow you to enter Setup.

The other way to enter Setup is to power on the computer, when the below message appears briefly at the bottom of the screen during the POST (Power On Self Test), press Key or simultaneously press <Ctrl>, <Alt>, and <Esc> keys.

Press DEL to enter SETUP.

If the message disappears before you respond and you still wish to enter Setup, restart the system to try again by turning it OFF then ON or pressing the "RESET" button on the system case.

You may also restart by simultaneously press <Ctrl>,<Alt>, and keys.

4.2. CONTROL KEYS

Up arrow	Move to previous item.
Down arrow	Move to next item.
Left arrow	Move to the item in the left hand.
Right arrow	Move to the item in the right hand.
Esc key	Main Menu - Quit and not save changes into CMOS Status Page Setup Menu and Option Page Setup Menu - Exit current page and return to Main Menu.
PgUp key	Increase the numeric value or make changes.
PgDn key	Decrease the numeric value or make changes.
F1 key	General help, only for Status Page Setup Menu and Option Page Setup Menu.
F2 key	Change color from total 16 colors.
F3 key	Calendar, only for Status Page Setup Menu.
F4 key	Reserved.
F5 key	Restore the previous CMOS value from CMOS, only for Option Page Setup Menu.
F6 key	Load the default CMOS value from BIOS default table, only for Option Page Setup Menu.
F7 key	Load the default.
F8 key	Reserved.
F9 key	Reserved.
F10 key	Save all the CMOS changes, only for Main Menu.

4.3. GETTING HELP

4.3.1. Main Menu

The on-line description of the highlighted setup function is displayed at the bottom of the screen.

4.3.2. Status Page Setup Menu / Option Page Setup Menu

Press F1 to pop up a small help window that describes the appropriate keys to use and the possible selections for the highlighted item. To exit the Help Window press <Esc>.

4.4. THE MAIN MENU

Once you enter Award BIOS CMOS Setup Utility, the Main Menu (Figure 4.1) will appear on the screen.

The Main Menu allows you to select setup functions and exit choices. Use arrow keys to select among the items and press <Enter> to accept or enter the sub-menu.

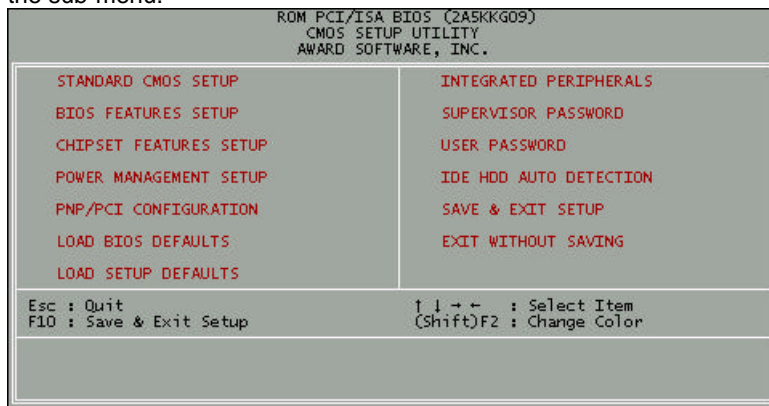

Figure 4.1: Main Menu

- Standard CMOS setup

This setup page includes all the items in a standard compatible BIOS.

- BIOS features setup

This setup page includes all the items of Award special enhanced features.

- Chipset features setup
This setup page includes all the items of chipset special features.
- Power management setup
This setup page includes all the items of Green function features.
- PNP/PCI configuration
This setup page includes all the items of PNP/PCI configuration features.
- Load BIOS defaults
BIOS defaults indicates the most appropriate value of the system parameter which the system would be in safe configuration.
- Load setup defaults
Setup defaults indicates the most appropriate value of the system parameter which the system would be in safe configuration.
- Integrated Peripherals
This setup page includes all the items of peripherals features.
- Supervisor Password
Change, set, or disable password. It allows you to limit access to the system and Setup, or just to Setup.
- User Password
Change, set, or disable password. It allows you to limit access to the system.
- IDE HDD auto detection
Automatically configure hard disk parameter.
- Save & exit setup
Save CMOS value changes to CMOS and exit setup.
- Exit without save

Abandon all CMOS value changes and exit setup.

4.5. STANDARD CMOS SETUP MENU

The items in Standard CMOS Setup Menu (Figure 4.2) are divided into 9 categories. Each category includes no, one or more than one setup items. Use the arrows to highlight the item and then use the <PgUp> or <PgDn> keys to select the value you want in each item.

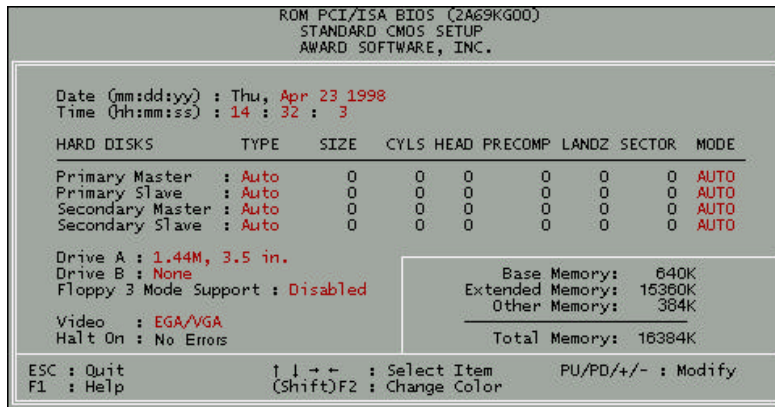

Figure 4.2: Standard CMOS Setup Menu

- Date

The date format is <day>, <date> <month> <year>. Press <F3> to show the calendar.

Day	The day, from Sun to Sat, determined by the BIOS and is display-only
Date	The date, from 1 to 31 (or the maximum allowed in the month)
Month	The month, Jan. through Dec.
Year	The year, from 1994 through 2079

- Time

The time format in <hour> <minute> <second>.

The time is calculated base on the 24-hour military-time clock.

For example, 1 p.m. is 13:00:00.

- Primary HDDs / Secondary HDDs

The category identify the types of hard disk from drive C to drive F
4 devices that has been installed in the computer.

There are three options for definable type; User, Auto and None .

Type User is user-definable; and type Auto means automatically
detecting HDD's type and None means No IDE HDD installed.

If you select Type User, related information is asked to be entered to the
following items.

Enter the information directly from the keyboard and press <Enter>.

Those information should be provided in the documentation from your
hard disk vendor or the system manufacturer.

CYLS.	number of cylinders
HEADS	number of heads
PRECOMP	write precomp
LANDZONE	landing zone
SECTORS	number of sectors

If a hard disk has not been installed select NONE and press <Enter>.

- Drive A type / Drive B type

The category identify the types of floppy disk drive A or drive B that has
been installed in the computer.

None	No floppy drive installed
360K, 5.25 in.	5-1/4 inch PC-type standard drive; 360 kilobyte capacity.
1.2M, 5.25 in.	5-1/4 inch AT-type high-density drive; 1.2 megabyte capacity (3-1/2 inch when 3 Mode is Enabled).

720K, 3.5 in.	3-1/2 inch double-sided drive; 720 kilobyte capacity
1.44M, 3.5 in.	3-1/2 inch double-sided drive; 1.44 megabyte capacity.
2.88M, 3.5 in.	3-1/2 inch double-sided drive; 2.88 megabyte capacity.

- Floppy 3 Mode Support (for Japan Area)

Disable	Normal Floppy Drive.
Drive A	Drive A is 3 mode Floppy Drive.
Drive B	Drive B is 3 mode Floppy Drive.
Both	Drive A & B are 3 mode Floppy Drive.

- Video

The category detects the type of adapter used for the primary system monitor that must match your video display card and monitor.

Although secondary monitors are supported, you do not have to select the type in setup.

EGA/VGA	Enhanced Graphics Adapter/Video Graphics Array. For EGA, VGA, SVGA, or PGA monitor adapters
CGA 40	Color Graphics Adapter, power up in 40 column mode
CGA 80	Color Graphics Adapter, power up in 80 column mode
MONO	Monochrome adapter, includes high resolution monochrome adapters

- Halt on

The category determines whether the computer will stop if an error is detected during power up.

NO Errors	The system boot will not be stopped for any error that may be detected
All Errors	Whenever the BIOS detects a non-fatal error, the system will be stopped and you will be prompted
All, But Keyboard	The system boot will not stop for a keyboard error; it will stop for all other errors

All, But Diskette	The system boot will not stop for a disk error; it will stop for all other errors
All, But Disk/Key	The system boot will not stop for a keyboard or disk error; it will stop for all other errors

- **Memory**

The category is display-only which is determined by POST (Power On Self Test) of the BIOS.

Base Memory

The POST of the BIOS will determine the amount of base (or conventional) memory installed in the system.

The value of the base memory is typically 512 K for systems with 512 K memory installed on the motherboard, or 640 K for systems with 640 K or more memory installed on the motherboard.

Extended Memory

The BIOS determines how much extended memory is present during the POST.

This is the amount of memory located above 1 MB in the CPU's memory address map.

Expanded Memory

Expanded Memory in memory defined by the Lotus / Intel / Microsoft (LIM) standard as EMS.

Many standard DOS applications can not utilize memory above 640, the Expanded Memory Specification (EMS) swaps memory which not utilized by DOS with a section, or frame, so these applications can access all of the system memory.

Memory can be swapped by EMS is usually 64K within 1 MB or memory above 1 MB, depends on the chipset design.

Expanded memory device driver is required to use memory as Expanded Memory.

Other Memory

This refers to the memory located in the 640 to 1024 address space. This is memory that can be used for different applications.

DOS uses this area to load device drivers to keep as much base memory free for application programs. Most use for this area is Shadow RAM.

4.6. BIOS FEATURES SETUP

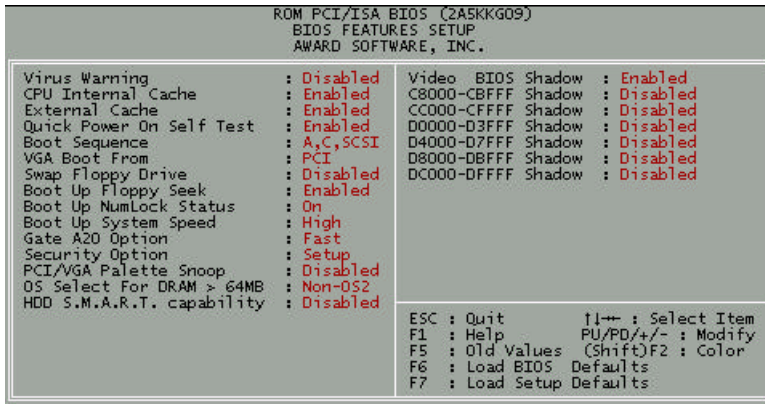

Figure 4.3: BIOS Features Setup

- Virus Warning

This category flashes on the screen. During and after the system boots up, any attempt to write to the boot sector or partition table of the hard disk drive will halt the system and the following error message will appear, in the mean time, you can run anti-virus program to locate the problem.

The default value is Disabled.

Enabled	Activate automatically when the system boots up causing a warning message to appear when anything attempts to access the boot sector or hard disk partition table.
Disabled	No warning message appears when anything attempts to access the boot sector or hard disk partition table.

- CPU Internal Cache / External Cache

These two categories speed up memory access. However, it depends on CPU / chipset design.

The default value is Enabled.

Enabled	Enable cache function.
Disabled	Disable cache function.

- Quick Power On Self Test

This category speeds up Power On Self Test (POST) after you power on the computer. If it set to Enable, BIOS will skip some check items during POST.

The default value is Enabled.

Enabled	Enable quick POST.
Disabled	Normal POST.

- Boot Sequence

This category determines which drive computer searches first for the disk operating system (i.e., DOS). Default value is A, C, SCSI.

X1, X2, X3	System will first search for X1 disk drive then X2 disk drive and then X3 disk drive.
------------	---

- VGA Boot From

The default value is PCI.

AGP	System will boot from AGP Display Card
PCI	System will boot from PCI VGA Card

- Swap Floppy Drive

The default value is Disabled.

Enabled	Floppy A & B will be swapped under DOS.
Disabled	Floppy A & B will be normal definition.

- Boot Up Floppy Seek

During POST, BIOS will determine if the floppy disk drive installed is 40 or 80 tracks. 360 type is 40 tracks while 720 , 1.2 and 1.44 are all 80 tracks.

The default value is Enabled.

Enabled	BIOS searches for floppy disk drive to determine if it is 40 or 80 tracks. Note that BIOS can not tell from 720, 1.2 or 1.44 drive type as they are all 80 tracks.
Disabled	BIOS will not search for the type of floppy disk drive by track number. Note that there will not be any warning message if the drive installed is 360 .

- Boot Up NumLock Status

The default value is On.

On	Keypad is number keys.
Off	Keypad is arrow keys.

- Boot Up System Speed

The default value is High.

High	Set Boot Up System Speed: High.
Low	Set Boot Up System Speed: Low.

- Gate A20 Option

The default value is Fast.

Fast	Set Boot Up System Speed: High.
Normal	Set Boot Up System Speed: Low.

- Security option

The default value is Setup.

Setup	The system will boot and access to Setup will be denied if the correct password is not entered at the prompt.
System	The system will not boot and access to Setup will be denied if the correct password is not entered at the prompt.

- **To disable security, select PASSWORD SETTING at Main Menu and then you will be asked to enter password. If the user does not type anything and just press <Enter>, it will disable security. Once the**

security is disabled, the system will boot and you can enter Setup freely.

- PCI/VGA Palette Snoop

The default value are Disabled.

Enabled	For having Video Card on ISA Bus and VGA Card on PCI Bus.
Disabled	For VGA Card only.

- OS Select For DRAM>64MB

The default value is Non-OS2.

Non-OS2	Using non-OS2 operating system.
OS2	Using OS2 operating system and DRAM>64MB.

- HDD S.M.A.R.T. Capability

The default value is Disable.

Enable	Enable HDD S.M.A.R.T. Capability
Disable	Disable HDD S.M.A.R.T. Capability

- Video BIOS Shadow

It determines whether video BIOS will copied to RAM, however, it is optional from chipset design. Video Shadow will increase the video speed.

The default value is Enable.

Enabled	Video shadow is enabled.
Disabled	Video shadow is disabled.

- C8000 - CFFFF Shadow / D0000 - DFFFF Shadow

These categories determine whether optional ROM will be copied to RAM by 16 byte. The default value are Disabled.

Enabled	Optional shadow is enabled.
Disabled	Optional shadow is disabled.

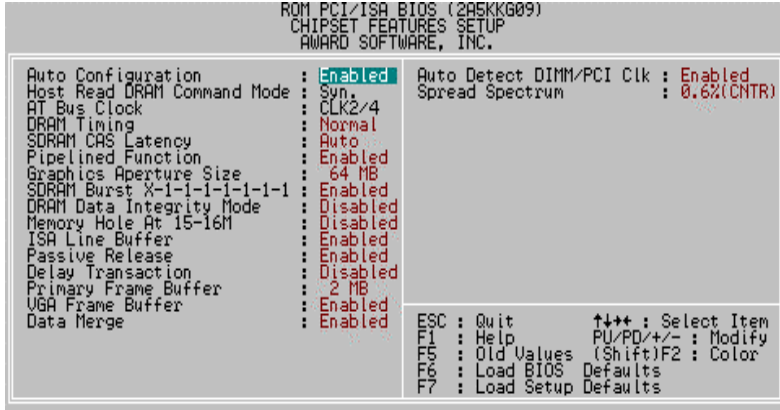

4.7. CHIPSET FEATURES SETUP

Figure 4.4: Chipset Features Setup

- Auto Configuration

The default value is Enabled.

Enabled	For General State.
Disabled	For Special SDRAM Timing and ISA CLK.

- Host Read DRAM Command Mode.

The default value is Syn.

Bypass	Set DRAM Cycle Start at T3 clock after ADS#.
Syn.	Set DRAM Cycle Start at T3+1 clock after ADS#.

- AT Bus Clock

The default value is CLK2/4.

CLK2/3	Set AT Bus Clock to CLK2/3.
--------	-----------------------------

CLK2/4	Set AT Bus Clock to CLK2/4.
7.159MHz	Set AT Bus Clock to 7.159MHz.

- DRAM Timing

The default value is Normal.

Normal	For normal DRAM timing operation.
Fast	For Fastest DRAM timing operation.
Slow	For Slower DRAM timing operation.

- SDRAM CAS Latency

The default value is AUTO.

3	For Slower SDRAM DIMM module.
2	For Fastest SDRAM DIMM module.
Auto	CAS latency time will be set automatically if you have SPD on SDRAM

- Pipelined Function

The default value is Enable.

Enable	Enable Pipelined Function.
Disable	Disable Pipelined Function.

- Graphics Aperture Size

The default value is 64MB.

16MB	Set Graphics Aperture Size to 16MB.
32MB	Set Graphics Aperture Size to 32MB.
64MB	Set Graphics Aperture Size to 64MB.
128MB	Set Graphics Aperture Size to 128MB.
256MB	Set Graphics Aperture Size to 256MB.

- SDRAM Burst X-1-1-1-1-1-1-1

The default value is Enable.

Enable	Enable SDRAM Burst X-1-1-1-1-1-1-1.
Disable	Disable SDRAM Burst X-1-1-1-1-1-1-1.

- DRAM Data Integrity Mode

The default value is Disable.

ECC	Set DRAM Data Integrity Mode to ECCMode.
Parity	Set DRAM Data Integrity Mode to ParityMode.
Disable	Disable DRAM Data Integrity Mode.

- Memory Hole at 15M-16M

The default value is Disabled.

Enabled	Set Address=15-16MB relocate to ISA BUS.
Disabled	Normal Setting.

- ISA Line Buffer

The default value is Enabled.

Enabled	Enable ISA Line Buffer.
Disabled	Disable ISA Line Buffer.

- Passive Release

The default value is Enabled.

Enabled	Enable Passive Release.
Disabled	Disable Passive Release.

- Delay Transaction

The default value is Disabled.

Enabled	Enable Delay Transaction.
Disabled	Disable Delay Transaction.

- Primary Frame Buffer

The default value is 2MB.

1MB	Set Primary Frame Buffer to 1MB.
2MB	Set Primary Frame Buffer to 2MB.
4MB	Set Primary Frame Buffer to 4MB.
8MB	Set Primary Frame Buffer to 8MB.
16MB	Set Primary Frame Buffer to 16MB.
ALL	Set Primary Frame Buffer to ALL.
Disabled	Disable Primary Frame Buffer.

- VGA Frame Buffer

The default value is Enabled.

Enabled	Enable VGA Frame Buffer.
Disabled	Disable VGA Frame Buffer.

- Data Merge

The default value is Enabled.

Enabled	Enable Data Merge.
Disabled	Disable Data Merge.

- Auto Detect DIMM/PCI Clk

The default value is Enabled.

Enabled	Enabled Auto Detect DIMM/PCI Clk.
Disabled	Disabled Auto Detect DIMM/PCI Clk.

- Spread Spectrum

The default value is 0.6% (CNTR)

Disabled	Normal
0.6%(CNTR)	Set Spread Spectrum 0.6%(CNTR)

4.8. POWER MANAGEMENT SETUP

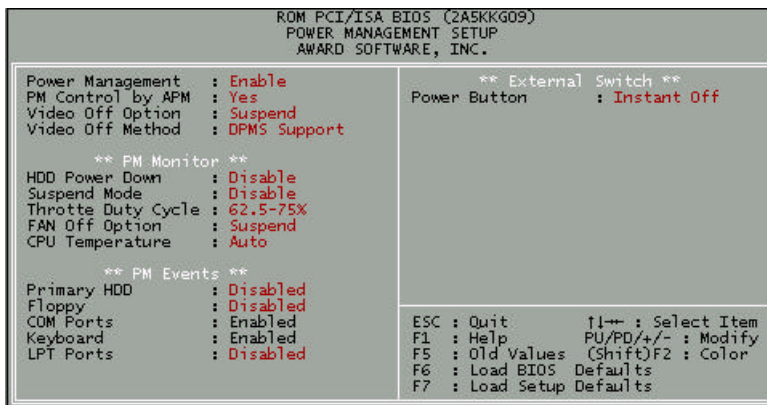

Figure 4.5: Power Management Setup

- Power Management

The default value is Enabled.

Enabled	Enable Green function.
Disabled	Disable Green function.

- PM Control by APM

The default value is Yes.

Yes	Enable software APM function.
No	Disable software APM function.

- Video off Option

The default value is Suspend.

Suspend	Set Video off if system enter Suspend Mode.
Always On	Set Video always on.

- Video Off Method

The default value is DPMS Support.

V/H SYNC + Blank	BIOS will turn off V/H-SYNC when gets into Green mode for Green monitor power saving.
Blank Screen	BIOS will only black monitor when gets into Green mode.
DPMS Support	BIOS will use DPMS Standard to control VGA card. (The Green type VGA card will turn of V/H-SYNC automatically.)

- HDD Power Down

The default value is Disable.

Disable	Disable HDD Power Down mode function.
1-15 mins.	Enable HDD Power Down mode between 1 to 15 mins.

- Suspend Mode

The default value is Disable.

Disabled	Disable Suspend Mode.
1 min - 1 Hour	Setup the timer to enter Suspend Mode.

- Throttle Duty Cycle

The default value is 62.5-75%.

12.5-25%	Set Throttle Duty Cycle is 12.5-25%.
37.5-50%	Set Throttle Duty Cycle is 37.5-50%.
62.5-75%	Set Throttle Duty Cycle is 62.5-75%.
Disable	Disable Throttle Duty Cycle.

- FAN off Option

The default value is Suspend.

Suspend	Set FAN off if system enter Suspend Mode.
---------	---

Always On	Set FAN always on.
-----------	--------------------

- CPU Temperature

The default value is Auto.

Auto	Set CPU Temperature Automatically.
65°C / 149°F	Monitor CPU Temp. at 65°C / 149°F. if Temp. > 65°C / 149°F, the speed of CPU will be slow down.
70°C / 158°F	Monitor CPU Temp. at 70°C / 158°F. if Temp. > 70°C / 158°F, the speed of CPU will be slow down.
75°C / 167°F	Monitor CPU Temp. at 75°C / 167°F. if Temp. > 75°C / 167°F, the speed of CPU will be slow down.
80°C / 176°F	Monitor CPU Temp. at 80°C / 176°F. if Temp. > 80°C / 176°F, the speed of CPU will be slow down.
Disable	Disable the Function.

- Primary HDD

The default value is Disabled.

Enabled	Disable Primary HDD Ports Activity.
Disabled	Enable Primary HDD Ports Activity.

- Floppy

The default value is Disabled.

Enabled	Enable Floppy Ports Activity.
Disabled	Disable Floppy Ports Activity.

- COM Ports

The default value is Enable.

Enabled	Enable COM Ports Activity.
---------	----------------------------

- Keyboard

The default value is Enable.

Enabled	Enable Keyboard Activity.
---------	---------------------------

- LPT Ports

The default value is Disabled.

Enabled	Enable LPT Ports.
Disabled	Disable LPT Ports.

- Power Button

The default value is InstantOff.

Instantoff	Soft switch ON/OFF for POWER ON/OFF.
Delay 4Sec.	Soft switch ON 4sec. for POWER OFF.

4.9.PNP/PCI CONFIGURATION

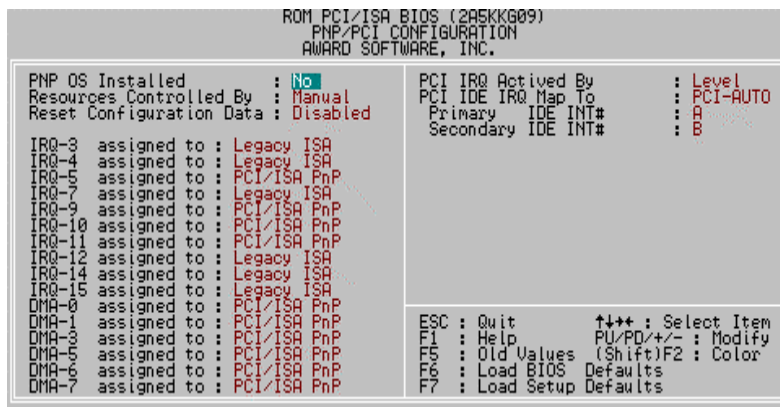

Figure 4.6: PCI Slot Configuration

- PNP OS Installed

The default value is No.

Yes	Enable PNP OS Installed function.
No	Disable PNP OS Installed function.

- Resources Controlled by

The default value is Manual.

Manual	User can set the PnP resource (I/O Address, IRQ & DMA channels) used by legacy ISA DEVICE.
Auto	BIOS automatically use these PnP rescuers.

- Reset Configuration Data

The default value is Disabled.

Disabled	Disable this function.
Enabled	Enable clear PnP information in ESCD.

- IRQ (3,4,5,7,9,10,11,12,14,15), DMA(0,1,3,5,6,7) assigned to

The default value is "Legacy ISA" or "PCI/ISA PnP".

Legacy ISA	The resource is used by Legacy ISA device.
PCI/ISA PnP	The resource is used by PCI/ISA PnP device (PCI or ISA).

- PCI IRQ Activated By

The default value is Level.

Level	Set PCI IRQ Activated by Level.
Edge	Set PCI IRQ Activated by Edge.

- PCI IDE IRQ Map To

The default value is PCI-AUTO.

PCI-AUTO	Map PCI IDE IRQ to PCI slot automatically.
ISA	Map PCI IDE IRQ to ISA slot.

- Primary/Secondary IDE INT#

A	Set INTA for primary/secondary PCI IDE.
B	Set INTB for primary/secondary PCI IDE.
C	Set INTC for primary/secondary PCI IDE.
D	Set INTD for primary/secondary PCI IDE.

4.10. LOAD BIOS DEFAULTS

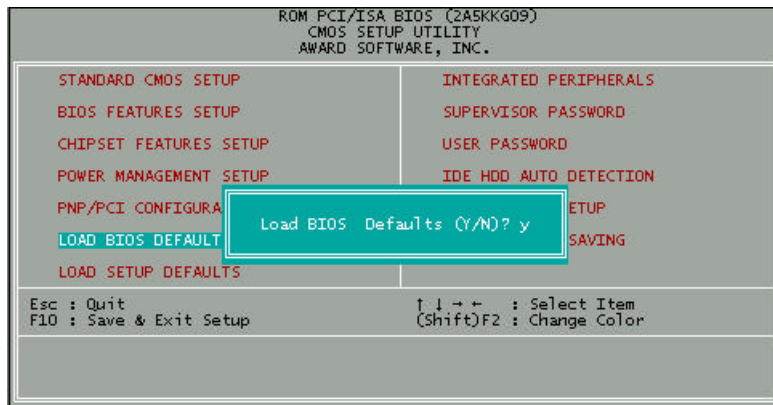

Figure 4.7: Load BIOS Defaults

- Load BIOS Defaults

To load BIOS defaults value to CMOS SRAM, enter "Y". If not, enter "N".

4.11. LOAD SETUP DEFAULTS

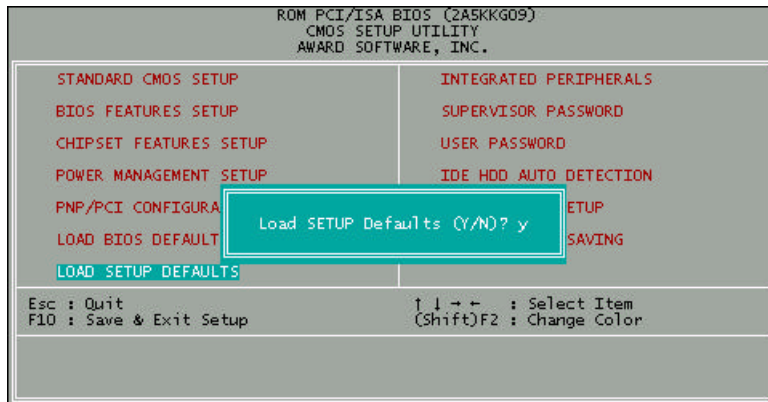

Figure 4.8: Load Setup Defaults

- Load SETUP Defaults

To load SETUP defaults value to CMOS SRAM, enter "Y". If not, enter "N".

- **If there is any problem occurred, loading BIOS DEFAULTS step is recommended.**

4.12. INTEGRATED PERIPHERALS

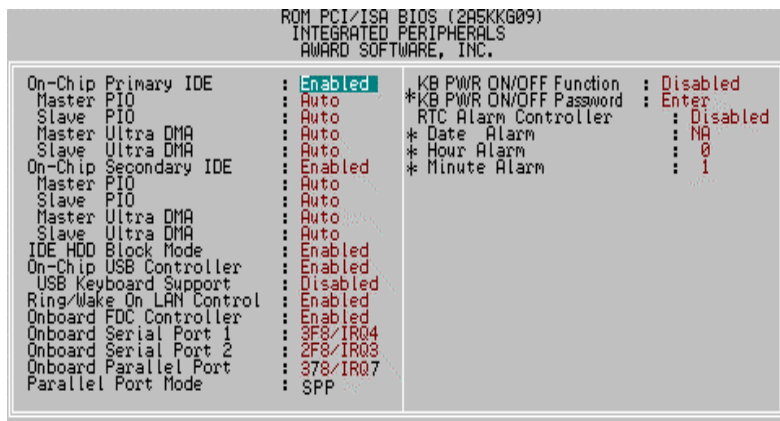

Figure 4.9: Integrated peripherals

*When KB PWR ON/OFF Function set Enabled, KB PWR ON/OFF Password : Enter will show up.

* These three items will show up when RTC Alarm Controller is enabled.

- On-Chip Primary IDE

The default value is Enabled.

Enabled	Enable onboard 1st channel IDE port.
Disabled	Disable onboard 1st channel IDE port.

- Master PIO (for onboard IDE 1st channel).

The default value is Auto.

Auto	BIOS will automatically detect the IDE HDD Accessing mode.
Mode0~4	Manually set the IDE Accessing mode.

- Slave PIO (for onboard IDE 1st channel).

The default value is Auto.

Auto	BIOS will automatically detect the IDE HDD Accessing mode.
Mode0~4	Manually set the IDE Accessing mode.

- Master Ultra DMA (for onboard IDE 1sd channel).

The default value is Auto.

Auto	BIOS will automatically detect the IDE HDD Accessing mode.
Disabled	Disable UDMA function.

- Slave Ultra DMA (for onboard IDE 1sd channel).

The default value is Auto.

Auto	BIOS will automatically detect the IDE HDD Accessing mode.
Disabled	Disable UDMA function.

- On-Chip Secondary IDE

The default value is Enabled.

Enabled	Enable onboard 2nd channel IDE port.
Disabled	Disable onboard 2nd channel IDE port.

- Master PIO (for onboard IDE 2nd channel).

The default value is Auto.

Auto	BIOS will automatically detect the IDE HDD Accessing mode.
Mode0~4	Manually set the IDE Accessing mode.

- Slave PIO (for onboard IDE 2nd channel).

The default value is Auto.

Auto	BIOS will automatically detect the IDE HDD Accessing mode.
Mode0~4	Manually set the IDE Accessing mode.

- Master Ultra DMA (for onboard IDE 2nd channel).

The default value is Auto.

Auto	BIOS will automatically detect the IDE HDD Accessing mode.
Disabled	Disable UDMA function.

- Slave Ultra DMA (for onboard IDE 2nd channel).

The default value is Auto.

Auto	BIOS will automatically detect the IDE HDD Accessing mode.
Disabled	Disable UDMA function.

- IDE HDD Block Mode

The default value is Enabled.

Enabled	Enable IDE HDD Block Mode
Disabled	Disable IDE HDD Block Mode

- On-Chip USB Controller

The default value is Enabled.

Disabled	Disable USB Controller.
Enabled	Enable USB Controller.

- USB Keyboard Support

The default value is Disabled.

Disabled	Disable USB Keyboard Support.
Enabled	Enable USB Keyboard Support.

- Ring / Wake On Lan Control

The default value is Enable.

Enabled	Enable Modem Ring On / Wake On Lan function.
Disabled	Disable this function.

- Onboard FDC Controller

The default value is Enabled.

Enabled	Enable onboard Floppy port.
Disabled	Disable onboard Floppy port.

- Onboard Serial Port 1

The default value is 3F8/IRQ4.

Auto	BIOS will automatically setup the port 1 address.
3F8/IRQ4	Enable onboard Serial port 1 and address is 3F8.
2F8/IRQ3	Enable onboard Serial port 1 and address is 2F8.
3E8/IRQ4	Enable onboard Serial port 1 and address is 3E8.
2E8/IRQ3	Enable onboard Serial port 1 and address is 2E8.
Disabled	Disable onboard Serial port 1.

- Onboard Serial Port 2

The default value is 2F8/IRQ3.

Auto	BIOS will automatically setup the port 2 address.
3F8/IRQ4	Enable onboard Serial port 2 and address is 3F8.
2F8/IRQ3	Enable onboard Serial port 2 and address is 2F8.
3E8/IRQ4	Enable onboard Serial port 2 and address is 3E8.
2E8/IRQ3	Enable onboard Serial port 2 and address is 2E8.
Disabled	Disable onboard Serial port 2.

- Onboard Parallel port

The default value is 378/IRQ7.

378/IRQ7	Enable onboard LPT port and address is 378/IRQ7.
278/IRQ5	Enable onboard LPT port and address is 278/IRQ5.
Disabled	Disable onboard LPT port.
3BC/IRQ7	Enable onboard LPT port and address is 3BC/IRQ7.

- KB PWR ON/OFF Function

The default value is Disabled.

Disabled	Disabled KB PWR ON/OFF Function
Enabled	Enabled KB PWR ON/OFF Function

KB PWR ON/OFF Password

The default value is Enter.

-  KB PWR ON/OFF Function Set Enabled, KB PWR ON/OFF Password : Enter will show up. When users enabled KB PWR ON/OFF Function, please set password with three different characters, and press the three different characters password at the same time. For example, if users set “abc” as password , then he would press “a” “b” “c” at the same time. (a-b-c is hot key) .

- RTC Alarm Controller

The default value is Disabled.

Disabled	Disable this function.
Enabled	Enable alarm function to POWER ON system.

If RTC Alarm Controller is Enabled.

Date Alarm :	NA,1~31
Hour Alarm :	0~24
MinuteAlarm :	0~59

4.13. SUPERVISOR / USER PASSWORD

When you select this function, the following message will appear at the center of the screen to assist you in creating a password.



Figure 4.10: Password Setting

Type the password, up to eight characters, and press <Enter>. The password typed now will clear previously entered password from CMOS memory.

You will be asked to confirm the password. Type the password again and press <Enter>. You may also press <Esc> to abort the selection and not enter a password.

To disable password, just press <Enter> when you are prompted to enter password. A message will confirm the password being disabled.

Once the password is disabled, the system will boot and you can enter Setup freely.

PASSWORD DISABLED

If you select System at Security Option of BIOS Features Setup Menu, you will be prompted for the password every time the system is rebooted or any time you try to enter Setup.

If you select Setup at Security Option of BIOS Features Setup Menu, you will be prompted only when you try to enter Setup.

4.14. IDE HDD AUTO DETECTION

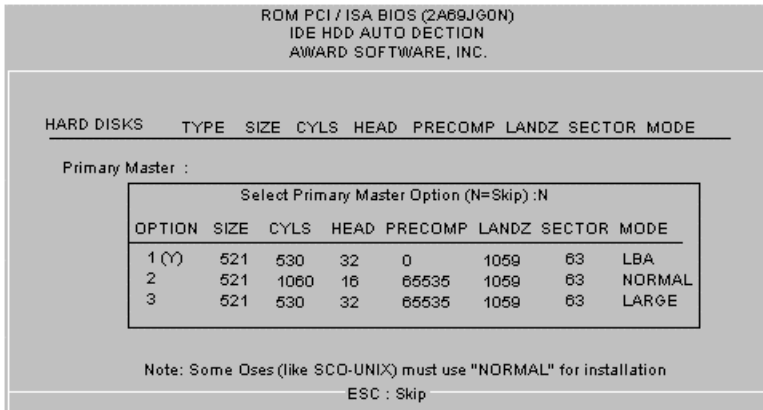

Figure 4.11: IDE HDD Auto Detection

Type "Y" will accept the H.D.D. parameter reported by BIOS.

Type "N" will keep the old H.D.D. parameter setup. If the hard disk cylinder NO. is over 1024, then the user can select LBA mode or LARGE mode for DOS partition larger than 528 MB.

4.15. SAVE & EXIT SETUP

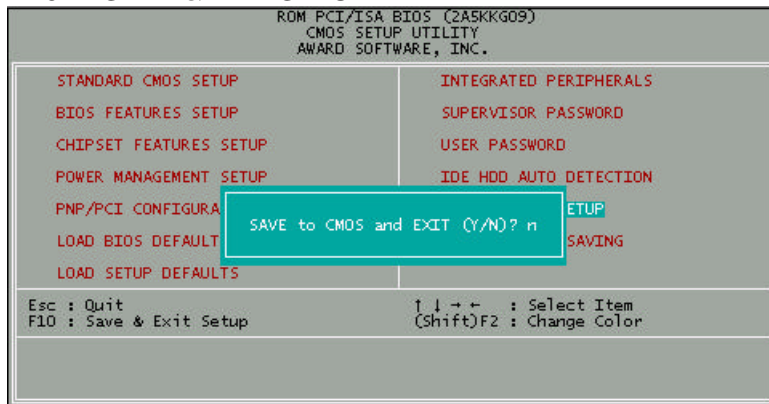

Figure 4.12: Save & Exit Setup

Type "Y" will quit the Setup Utility and save the user setup value to RTC CMOS SRAM.

Type "N" will return to Setup Utility.

4.16. EXIT WITHOUT SAVING

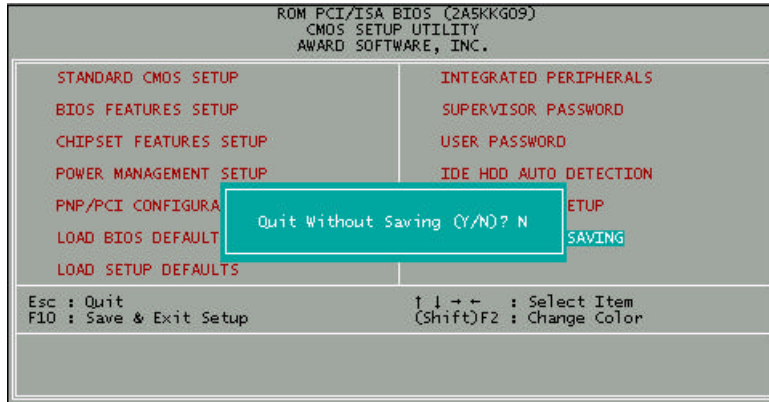

Figure 4.13: Exit Without Saving

Type "Y" will quit the Setup Utility without saving to RTC CMOS SRAM.

Type "N" will return to Setup Utility.

5. Troubleshooting

How to remove “?PCI Universal Serial Bus” under the Windows 95 ?

Method 1:

1. Please Install Windows 95 OSR2.1 attached file “USBSUPP.EXE”
2. Run this file and then system will restart.
3. Please go to the Device Manager , and remove “?PCI Universal Serial Bus”.
4. Please press “Refresh” button.
5. System will request your USB Driver under the directory
c:\windows\system\openhci.sys
6. Choose this directory and press “OK”, System will find Open HCI's USB Driver.
7. Restart your system.

Method 2:

1. Go to the web site of ALi (<http://www.ali.com.tw/eframes.htm>)
2. Download ALi USB Host Controller Supplement.
3. Install the file according to readme.

<p align="center">DECLARATION OF CONFORMITY Per FCC Part 2 Section 2.107(a)</p> <p align="center">FC</p> <p>Responsible Party Name: G.B.T. INC.</p> <p align="center">Address: 18365 Valley Blvd., Suite#A LA Puente, CA 91744</p> <p align="center">Phone/Fax No: (818) 854-9338 / (818) 854-9339</p> <p>I hereby declare that the product</p> <p>Product Name: Mother Board</p> <p>Model Number: GA-5AX</p> <p>Conforms to the following specifications:</p> <p>FCC Part 15, Subpart B, Section 15.107(a) and Section 15.109(a), Class B Digital Device.</p> <p>Supplementary Information:</p> <p><small>This device complies with part 15 of the FCC Rules. Operation is subject to the following two conditions: (1) This device may not cause harmful interference, and (2) this device must accept any interference received, including interference that may cause undesired operation.</small></p> <p>Representative Person's Name: <u>ERIC LIU</u></p> <p>Signature: <u>Eric Liu</u></p> <p>Date: <u>MAY 29, 1998</u></p>

FCC Compliance Statement:

This equipment has been tested and found to comply with limits for a Class B digital device, pursuant to Part 15 of the FCC rules. These limits are designed to provide reasonable protection against harmful interference in residential installations. This equipment generates, uses, and can radiate radio frequency energy, and if not installed and used in accordance with the instructions, may cause harmful interference to radio communications. However, there is no guarantee that interference will not occur in a particular installation. If this equipment does

cause interference to radio or television equipment reception, which can be determined by turning the equipment off and on, the user is encouraged to try to correct the interference by one or more of the following measures:

- Reorient or relocate the receiving antenna
- Move the equipment away from the receiver
- Plug the equipment into an outlet on a circuit different from that to which the receiver is connected
- Consult the dealer or an experienced radio/television technician for additional suggestions

You are cautioned that any change or modifications to the equipment not expressly approve by the party responsible for compliance could void Your authority to operate such equipment.

This device complies with Part 15 of the FCC Rules. Operation is subjected to the following two conditions 1) this device may not cause harmful interference and 2) this device must accept any interference received, including interference that may cause undesired operation.

Declaration of Conformity

We, Manufacturer/Importer
(full address)

G.B.T. Technology Trading GMBH
Ausschlagler Weg 41, 1F, 20537 Hamburg, Germany

declare that the product
(description of the apparatus, system, installation to which it refers)

Mother Board
GA-5AX

is in conformity with
(reference to the specification under which conformity is declared)
in accordance with 89/336 EEC-EMC Directive

- | | | | |
|--|--|---|--|
| <input type="checkbox"/> EN 55011 | Limits and methods of measurement of radio disturbance characteristics of industrial, scientific and medical (ISM) high frequency equipment | <input type="checkbox"/> EN 61000-3-2*
<input checked="" type="checkbox"/> EN60555-2 | Disturbances in supply systems caused by household appliances and similar electrical equipment "Harmonics" |
| <input type="checkbox"/> EN55013 | Limits and methods of measurement of radio disturbance characteristics of broadcast receivers and associated equipment | <input type="checkbox"/> EN61000-3-3*
<input checked="" type="checkbox"/> EN60555-3 | Disturbances in supply systems caused by household appliances and similar electrical equipment "Voltage fluctuations" |
| <input type="checkbox"/> EN 55014 | Limits and methods of measurement of radio disturbance characteristics of household electrical appliances, portable tools and similar electrical apparatus | <input checked="" type="checkbox"/> EN 50081-1
<input checked="" type="checkbox"/> EN 50082-1 | Generic emission standard Part 1: Residual, commercial and light industry
Generic immunity standard Part 1: Residual, commercial and light industry |
| <input type="checkbox"/> EN 55015 | Limits and methods of measurement of radio disturbance characteristics of fluorescent lamps and luminaries | <input type="checkbox"/> EN 55081-2 | Generic emission standard Part 2: Industrial environment |
| <input type="checkbox"/> EN 55020 | Immunity from radio interference of broadcast receivers and associated equipment | <input type="checkbox"/> EN 55082-2 | Generic immunity standard Part 2: Industrial environment |
| <input checked="" type="checkbox"/> EN 55022 | Limits and methods of measurement of radio disturbance characteristics of information technology equipment | <input type="checkbox"/> ENV 55104 | Immunity requirements for household appliances tools and similar apparatus |
| <input type="checkbox"/> DIN VDE 0855
part 10
<input type="checkbox"/> part 12 | Cabled distribution systems; Equipment for receiving and/or distribution from sound and television signals | <input type="checkbox"/> EN 50091- 2 | EMC requirements for uninterruptible power systems (UPS) |
| <input checked="" type="checkbox"/> CE marking | |  (EC conformity marking) | |

The manufacturer also declares the conformity of above mentioned product with the actual required safety standards in accordance with LVD 73/23 EEC

- | | | | |
|-----------------------------------|---|-------------------------------------|---|
| <input type="checkbox"/> EN 60065 | Safety requirements for mains operated electronic and related apparatus for household and similar general use | <input type="checkbox"/> EN 60950 | Safety for information technology equipment including electrical business equipment |
| <input type="checkbox"/> EN 60335 | Safety of household and similar electrical appliances | <input type="checkbox"/> EN 50091-1 | General and Safety requirements for uninterruptible power systems (UPS) |

Manufacturer/Importer

Signature : Rex Lin

(Stamp)

Date : MAY. 29, 1998

Name : Rex Lin