

**TS-AVD3**  
**USER'S MANUAL**  
**Intel Socket 370 Celeron/  
Pentium III FC-PGA Series**  
**Cyrix III Joshua Series**

***Transcend***

*Your Supplier, Your Partner,  
Your Friend.*

# TS-AVD3 Motherboard

Supporting Intel® Socket 370 Celeron™, Pentium III™ FC-PGA Series and Cyrix III Joshua Series Processor.

66/100/133 MHz Front Side Bus Frequency

## VIA® Apollo Pro 133 Chipset

### Welcome !!

Congratulations on your purchase of this great value motherboard, with its range of special features and innovative onboard functions, built around the advanced architecture of the new VIA® Apollo Pro Plus Chipset. More details to follow later in this manual.

### Our Website

Please come and visit us at our website on <http://www.transcendusa.com/> . You'll find plenty of interesting information about this and many other quality Transcend products.

### Your User's Manual

This User's Manual is designed to help end users and system manufacturers to set up and install the motherboard. All of the information within has been carefully checked for accuracy. However, Transcend Information, Inc. (hereafter referred to as "Transcend") carries no responsibility or liability for any errors or inaccuracies which this manual may contain. This includes references to products and software. In addition, the information and specifications are subject to change without prior notice.

### Disclaimer

Transcend provides this manual "as is" without any warranty of any kind, either expressed or implied, including - but not limited to - the implied warranties, conditions of merchantability or fitness for a particular purpose. Transcend, its management, employees, distributors and agents are in no way liable for any indirect special, incidental or consequential damages, including loss of profits, loss of business and the like. This is even if Transcend has been advised of the possibility of such damages arising from any defect or error in this manual or product.

### Trademarks

All brands, product names and trademarks mentioned in this document are the property of their respective owners or companies and are used solely for identification or explanation. It is Transcend policy to respect all product rights.

### Copyright

This manual may not, in whole or in part, be photocopied, reproduced, transcribed, translated or transmitted, in whatever form or language, without the written consent of the manufacturer, except for copies retained by the purchaser for personal archiving purposes.

Manual Version: 1.0

Release Date: April, 2000

Copyright © 2000 Transcend Information, Inc.

---

# Table of Contents

<b>CHAPTER 1 INTRODUCTION</b>	<b>1</b>
1.1 Essential Handling Precautions .....	1
1.2 Checklist: Hardware Required for Setup .....	2
1.3 Package Contents .....	2
1.4 Specifications and Features .....	3
<b>CHAPTER 2 HARDWARE INSTALLATION</b>	<b>5</b>
2.1 Transcend's TS-AVD3 Motherboard .....	5
2.2 Layout of Transcend's TS-AVD3 Motherboard .....	6
2.3 CPU Installation .....	7
2.4 66/100/133MHz System Configuration .....	9
2.5 CPU Internal Frequency Ratio Setting .....	9
2.6 Memory Configuration .....	11
2.7 Primary / Secondary IDE Connectors .....	12
2.8 Floppy Disk Drive Connector .....	13
2.9 Fan Power Connectors .....	13
2.10 Wake-on-LAN Connector .....	14
2.11 IrDA-Compliant Infrared Module Connector .....	14
2.12 Panel Connectors .....	15
2.13 Power Connector .....	17
2.14 External Back Panel I/O Ports .....	17
2.15 Clearing CMOS Using Jumper .....	18
2.16 Keyboard Wake Up.....	19

---

**CHAPTER 3 BIOS SETUP** **20**

3.1 BIOS Setup..... 20

3.2 The Main Menu ..... 20

3.3 Standard CMOS Setup..... 22

3.4 BIOS Features Setup ..... 25

3.5 Chipset Features Setup..... 28

3.6 Power Management Setup ..... 32

3.7 PnP/PCI Configuration Setup..... 35

3.8 Integrated Peripherals ..... 38

3.9 Supervisor Password..... 41

3.10 User Password ..... 42

3.11 IDE HDD Auto Detection ..... 42

3.12 Save & Exit Setup..... 43

3.13 Exit Without Saving ..... 43

3.14 Load BIOS Defaults..... 44

3.15 Load Setup Defaults ..... 44

**CHAPTER 4 BIOS UPGRADE** **45**

4.1 How to Check Your BIOS File Name and Version ..... 45

4.2 Downloading the Correct BIOS File from the Transcend Web Site.....45

4.3 How to Update Your Motherboard BIOS ..... 46

---

## CHAPTER 1 INTRODUCTION

### 1.1 Essential Handling Precautions

***IMPORTANT. Read this page before unpacking your motherboard!***

#### • **Power Supply**

Be careful! Always ensure that the computer is disconnected from the power supply when working on the motherboard and its components.

#### • **Static**

Static electricity may cause damage to the delicate integrated circuit chips on your motherboard. Before handling the motherboard outside of its protective packaging, ensure that there is no static electric charge in your body. To avoid this risk, please observe these simple precautions while handling the motherboard and other computer components:

1. If possible, wear an anti-static wrist strap. This fits around your wrist and is connected to a natural earth ground.
2. Touch a grounded or anti-static surface, or a metal fixture such as a pipe or the chassis of your system, before touching the motherboard.
3. When you have removed the motherboard from its anti-static packaging, try to hold it only by the edges, without touching any components.
4. Avoid contacting the components on add-on cards, motherboards, and modules with the golden fingers (gold-colored connectors) which plug into the expansion slots.
5. It is safest to handle system components only by their mounting brackets.
6. Keep components which are not connected to the system in the anti-static packaging whenever possible.

These precautions help to reduce the risk of static build-up and ensure any static discharge is harmless to your equipment.

#### • **Battery Replacement**

The battery which holds the system settings memory on your motherboard should not require replacement for at least five years, and probably much longer. In picture 2.2, it is located near the bottom right hand corner.

---

Please replace your battery only with the same type, or a similar type recommended by the manufacturer. If the battery is replaced incorrectly, there is a risk of a short circuit or explosion. Used batteries should be disposed of according to the manufacturer's instructions.

## • Electric Screwdrivers

To reduce the risk of damage to the motherboard due to excessive torque, avoid setting electric screwdrivers above 7.5 kg/cm.

## 1.2 Checklist: Hardware Required for Setup

It is advisable to have all of these items of hardware available *before* you unpack your motherboard from its anti-static packaging and start building your system.

- Computer case and chassis with appropriate power supply.
- Monitor.
- Slot 1 Central Processing Unit.
- DIMM memory module.
- PS/2 or USB Keyboard.
- PS/2 or USB Mouse.
- Hard Disk Drive.
- Floppy Disk Drive.
- CD-ROM Drive.
- (Optional) External Peripherals: printer, speakers, plotter, MODEM.
- (Optional) Internal Peripherals: MODEM, LAN cards.

## 1.3 Package Contents

This motherboard package should contain the following items. Please check them as soon as you unpack. If you find any damaged or missing items, please contact your retailer.

- TS-AVD3 motherboard
  - 1 x CD-ROM
  - 1 x FDD cable
  - 1 x Ultra DMA/66 cable
  - User's Manual
-

## **1.4 Specifications and Features**

### **• CPU**

- Supports Intel® Socket 370 Celeron™ and Pentium® III FC-PGA Series.
- Supports Cyrix III Joshua Series

### **• Chipset**

- VIA 693A/596B AGPset (133MHz Ultra DMA /66)

### **• DRAM Memory**

- Supports Synchronous DRAM
- Supports Virtual Channel Memory
- 3pcs of 168-pin DIMM module sockets on board
- 8~768MB memory size
- 8/16/32/64/128/256MB SDRAM DIMM
- Supports ECC
- 64 data bits structure only
- PC100 / PC133 SDRAM compliant

### **• I/O BUS Slot**

- 1 x AGP slot
- 5 x Master / Slave PCI slots (PCI 2.1 compliant)
- 1 x ISA slot (one PCI/ISA shared)

### **• I/O Functions**

- Supports PIO Mode 3,4 ATAPI devices and Ultra DMA/33/66
  - Supports 2 high speed UART 16550 COM ports
  - Supports SPP/EPP/ECP LPT port
  - Supports 1.44/2.88 MB floppy drive
  - Supports PS/2 Mouse and PS/2 Keyboard
  - Supports IrDA port
  - Supports 2 USB ports
-

- **Award BIOS**

- Supports Plug-and-Play, PC98
- Supports ACPI, APM, DMI and Green Feature
- Easy BIOS Recovery

- **Wake Up Features**

- PS/2 Mouse and Keyboard Wake Up
- Supports Wake-on-LAN function
- Remote Ring Wake Up
- Time Wake Up

- **PCB Dimensions**

- ATX form factor, 4-layer PCB, 20.4cm x 30.5cm (8 inch x 12 inch)

- **Switching Voltage Regulator**

- Intel VRM 8.4 compliant

- **Other Features**

- Year 2000 compliant
  - Anti-Virus Boot up
  - System voltage monitors for CPU Vcore, VTT, +3.3V, +/-5V and +/-12V
  - CPU temperature monitor
  - FAN speed monitor
-



## CHAPTER 2 HARDWARE INSTALLATION

### 2.1 Transcend's TS-AVD3 Motherboard

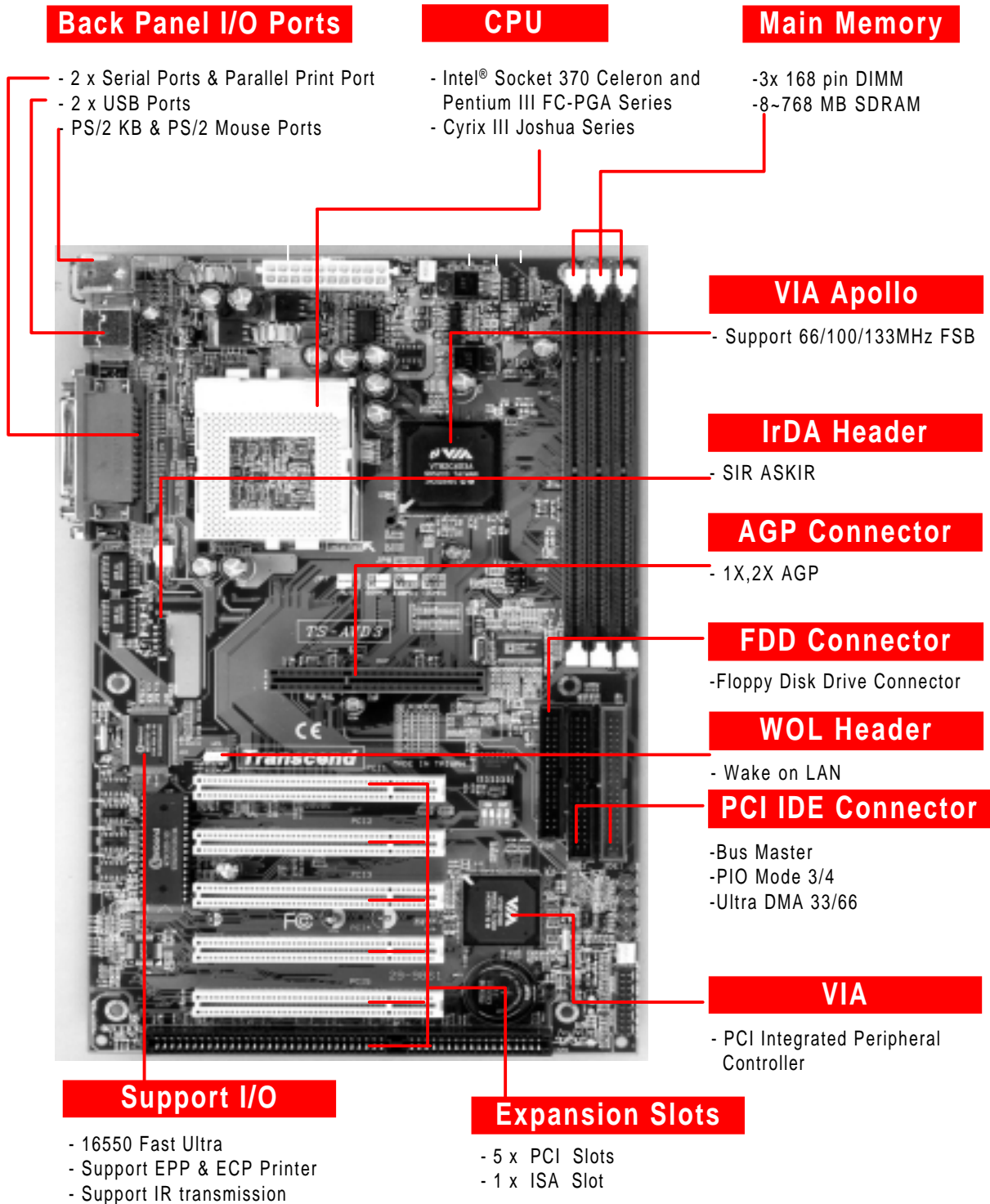

# 6

# HARDWARE INSTALLATION

## 2.2 Layout of Transcend's TS-AVD3 Motherboard

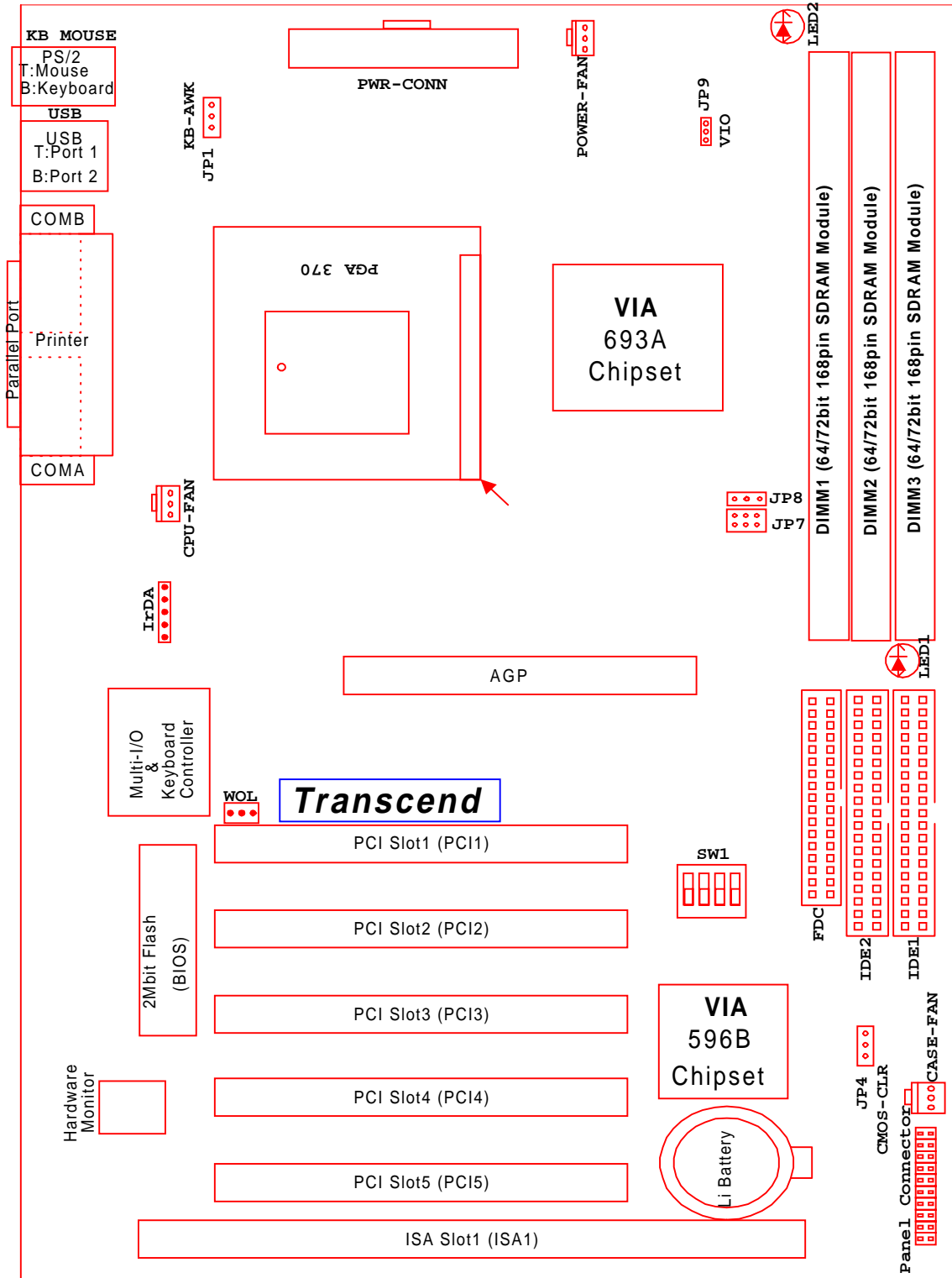

## 2.3 CPU (Central Processing Unit) Installation

So far you have familiarized yourself with the handling precautions, checked you have all of the necessary hardware for building your system, inspected the motherboard package contents and looked at the layout of the motherboard. This chapter will take you step by step through the process of installing the different hardware devices onto it.

### **Caution**

- 1. Remember to always make sure the system power is off before installing or removing any devices.**
- 2. Don't forget the static electricity precautions.**
- 3. Be careful ! Inserting hardware onto your motherboard incorrectly can damage it.**

The motherboard has a ZIF Socket 370 which houses the CPU. A fan is necessary for the CPU to prevent overheating. If there is no fan on it, please purchase one before you turn on your system.

**WARNING! Be sure that sufficient air circulation is available across the processor's passive heatsink. Without sufficient circulation, the processor could overheat and damage both the processor and the motherboard. You may install an auxiliary fan, if necessary.**

Please follow the steps below to install the CPU:

#### Step1:

To install the CPU, first turn off your system and remove its cover. Locate the ZIF socket and open it by first pulling the lever sideways away from the socket then upwards to a 90-degree right angle. Insert the CPU in the correct direction as shown below. The picture below is for reference only. You should have a CPU fan to cover the face of the CPU. With the added weight of the CPU fan, no force is required to insert the CPU. Once completely inserted, close the socket's lever while holding down the CPU.

---

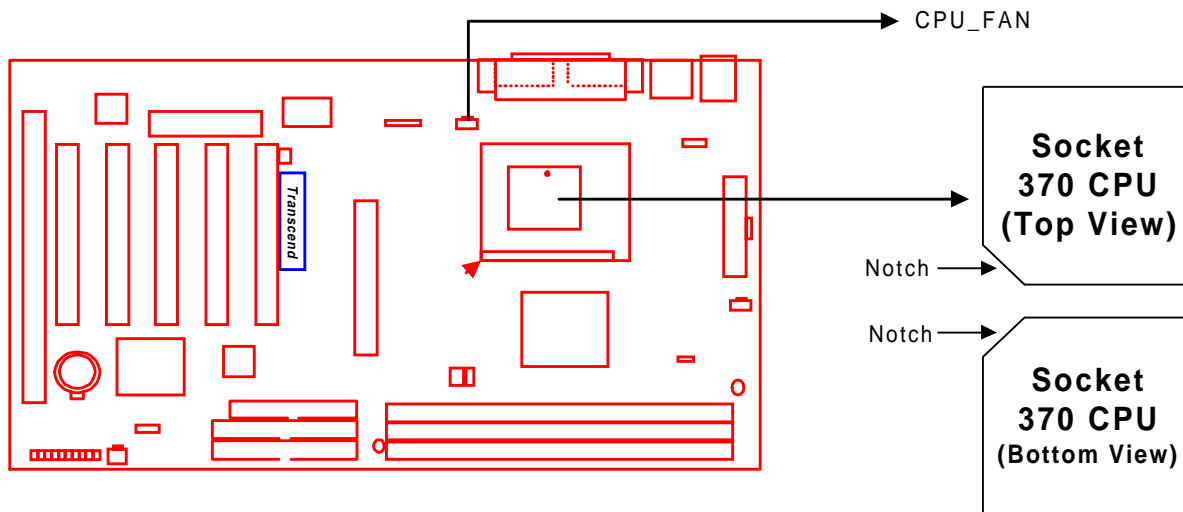

## Socket 370 CPU Installation

### Step2:

Next, according to the CPU type you install, set JP8 to short pin1 & pin2 for either Intel® Celeron™ and Pentium® III FC-PGA series CPUs, or set JP8 to short pin2 & pin3 for a CYRIX Joshua series CPU. Connect the CPU's fan cable to the CPU-FAN connector as indicated on the diagram below. Ensure that the cable is connected correctly! It will be obvious which way it fits.

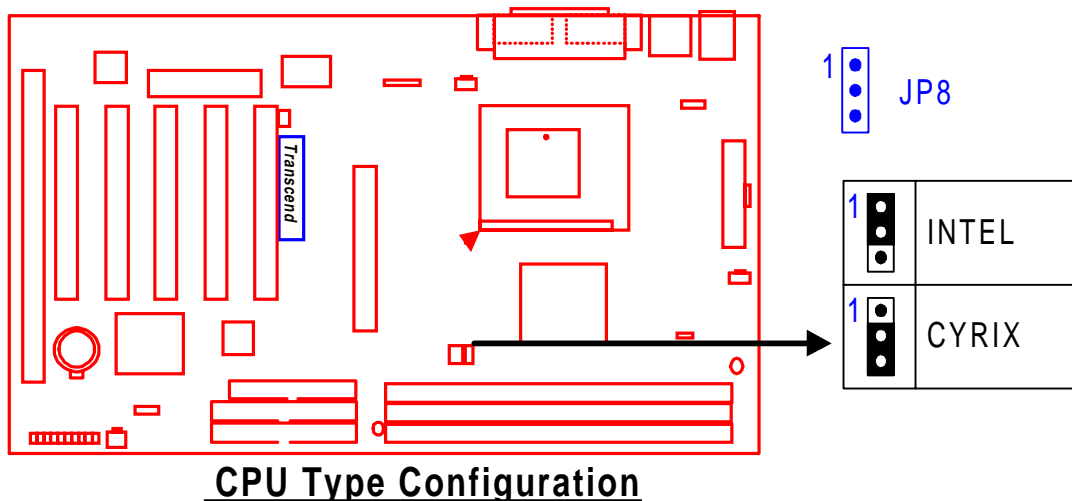

## 2.4 66/100/133MHz System Configuration

Jumper 7 (JP7) allows you to set the FSB (Front Side Bus) to 66, 100 or 133MHz configuration. When you set the FSB to 66MHz, you can select a system bus frequency from 66MHz to 83MHz through “CPU Host/PCI clock” in “Chipset Features Setup” (Please refer to page 30). When you set the FSB to 100MHz, you can select a system bus frequency from 100MHz to 124MHz through “CPU Host/PCI clock” in “Chipset Features Setup” (Please refer to page 30). When you set FSB to 133MHz, you can select the system bus frequency from 124MHz to 150MHz through “CPU Host/PCI clock” in “Chipset Features Setup” (Please refer to page 30).

**NOTE: If you are not familiar with this feature, we recommend you set this jumper to “AUTO”.**

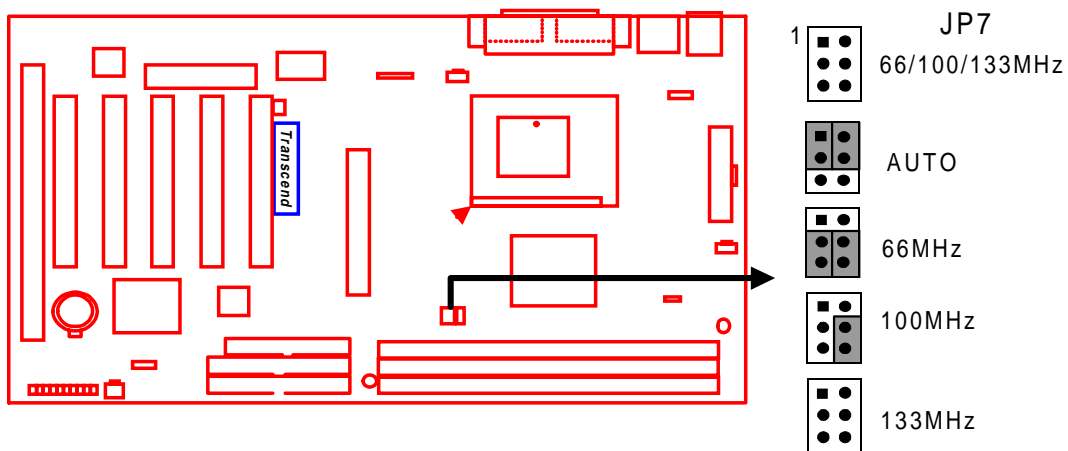

**66/100/133MHz FSB Configuration Jumper**

## 2.5 CPU Internal Frequency Ratio Setting

Switch 1 (SW1) is designated for adjusting the CPU internal frequency ratio. The frequency ratio is defined in the table shown below. The internal frequency can be calculated by the following formula:

$$\text{CPU internal frequency} = \text{frequency ratio} \times \text{system bus frequency} *$$

\* System bus frequency is set in “CPU Host/PCI Clock” of “Chipset Features Setup” in BIOS SETUP MENU (Please refer to page 30).







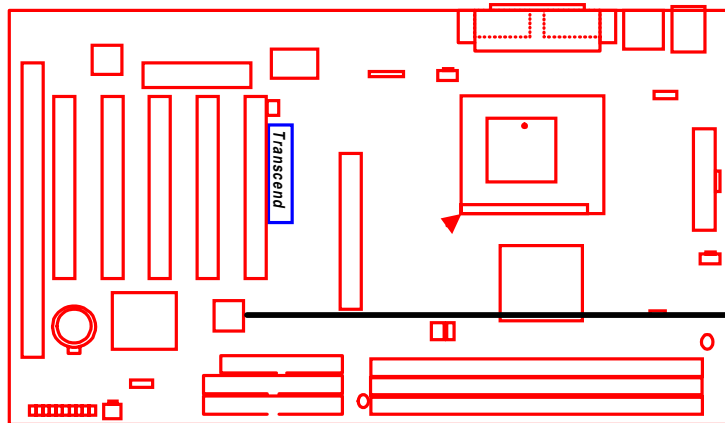



**NOTE: Because Intel has locked the frequency ratio for new CPUs, setting SW1 to adjust the frequency ratio is useless. However, it is effective for old version CPUs.**

# HARDWARE INSTALLATION

CPU Internal Frequency	JP1	Freq.-Ratio	SW1			
			1	2	3	4
233/350/466	66/100/133MHz	x 3.5	O	O	X	X
266/400/533	66/100/133MHz	x 4.0	O	X	O	O
300/450/600	66/100/133MHz	x 4.5	O	X	O	X
333/500/666	66/100/133MHz	x 5.0	O	X	X	O
366/550/733	66/100/133MHz	x 5.5	O	X	X	X
400/600/800	66/100/133MHz	x 6.0	X	O	O	O
433/650/866	66/100/133MHz	x 6.5	X	O	O	X
466/700/933	66/100/133MHz	x 7.0	X	O	X	O
500/750/1G	66/100/133MHz	x 7.5	X	O	X	X
533/800/1066	66/100/133MHz	x 8.0	X	X	O	O



SW1

-  : 233/350/466
-  : 266/400/533
-  : 300/450/600
-  : 333/500/666
-  : 366/550/733
-  : 400/600/800
-  : 433/650/866
-  : 466/700/933
-  : 500/750/1G
-  : 533/800/1066

## 2.6 Memory Configuration

This motherboard must be installed with DIMMs (Dual Inline Memory Modules). The DIMMs must be 3.3 Volt synchronous DRAM modules. The VIA Apollo Pro 133 chipset supports PC100, PC133, and Virtual Channel Memory (VCM). It also supports ECC (Error Checking and Correcting) mode. You can install memory in any combination as follows:

DIMM Location	168-pin DIMM
DIMM1	SDRAM 8,16, 32, 64,128, 256MBytes
DIMM2	SDRAM 8,16, 32, 64,128, 256MBytes
DIMM3	SDRAM 8,16, 32, 64,128, 256MBytes
Total Memory	768MBytes (max.)

**NOTE: Different type of DRAM modules should not be installed on one motherboard at the same time.**

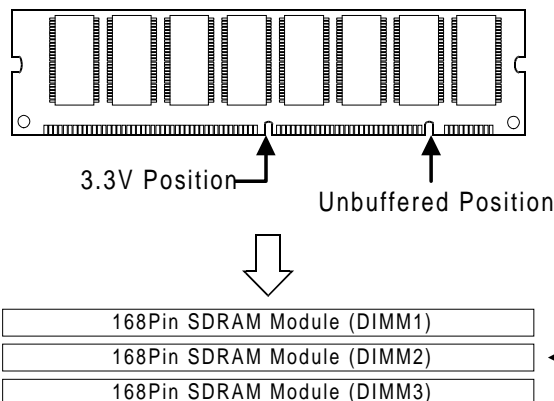
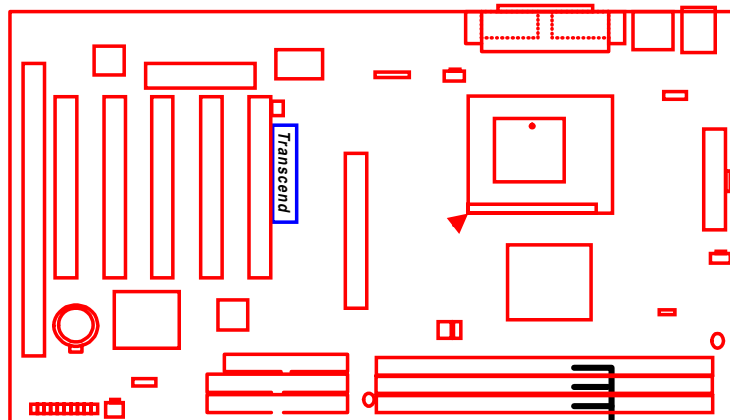

**168Pin DIMM Sockets**

## 2.7 Primary / Secondary IDE Connectors (Two 40-pin IDE)

This mainboard supports two 40-pin IDE connectors marked as IDE1 (primary IDE channel) and IDE2 (secondary IDE channel). Each channel supports two IDE devices, making a total of four devices. Connect your Hard Disk (the main one if you are using more than one) to the “Master” connector (at the end of the cable) and connect it to IDE1 (see important note below). If your HDD supports UltraDMA/66, you must use an 80-wire cable, otherwise the HDD won't be able to reach this speed.

If you intend to operate two IDE devices from the same channel, one device must be set to “Master” mode, the other to “Slave” mode. A Hard Disk, CD ROM or other IDE device can have either setting, depending on device's jumper. Please refer to the device's manual for more information.

**NOTE: The connectors must be attached to the IDE channels the right way round. Make sure that the red stripe on one edge of the ribbon cable (this may be faint and could also be a dotted line) is the nearest to PIN1 (on the left as the motherboard is shown in the picture below).**

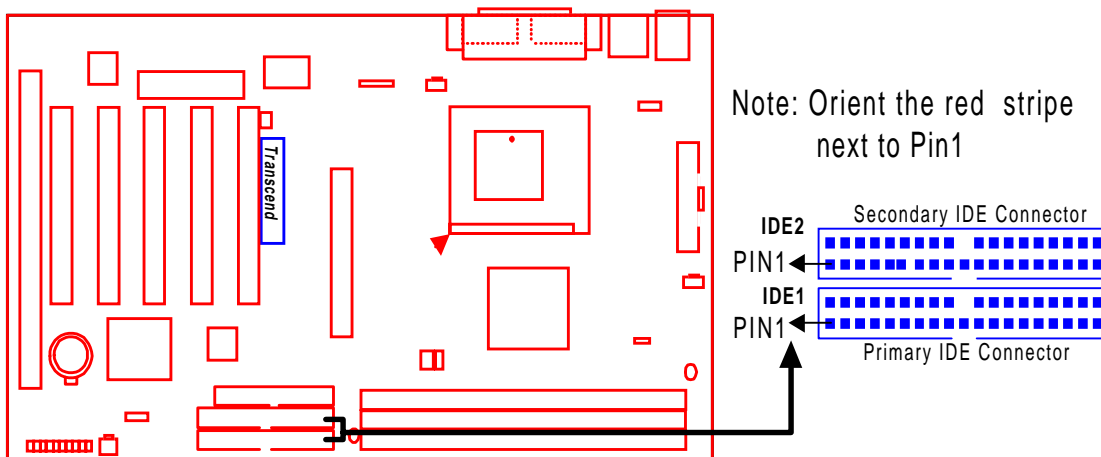

IDE Connectors

---



## 2.8 Floppy Disk Drive Connector (34-pin FDC)

This connector supports the provided floppy disk drive ribbon cable. After connecting the single end to the board, connect the two plugs on the other end to the floppy drives.

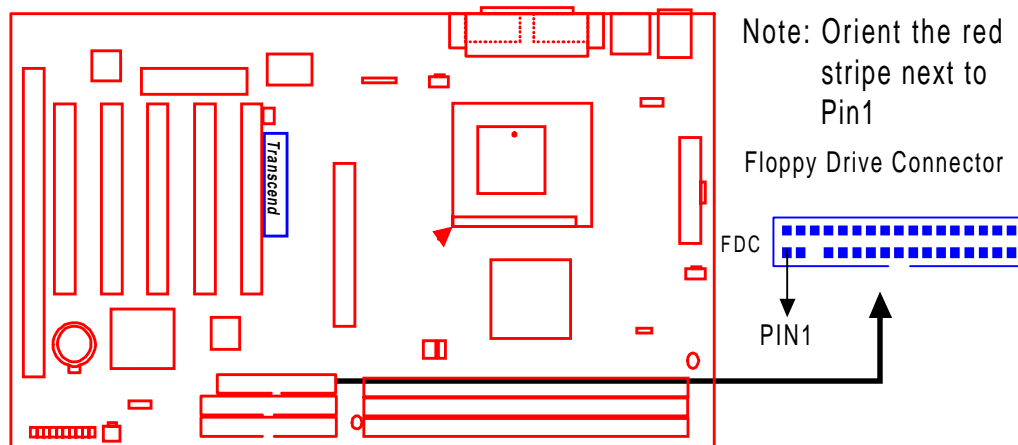

**Floppy Disk Drive Connector**

## 2.9 Fan Power Connectors

There are three fan power connectors on the mainboard: CPU-FAN, POWER-FAN, and CASE-FAN. Each connector provides +12V power. Make sure they are in the right orientation, or they may cause damage. These connectors support cooling fans of 500 mA (6W) or less.

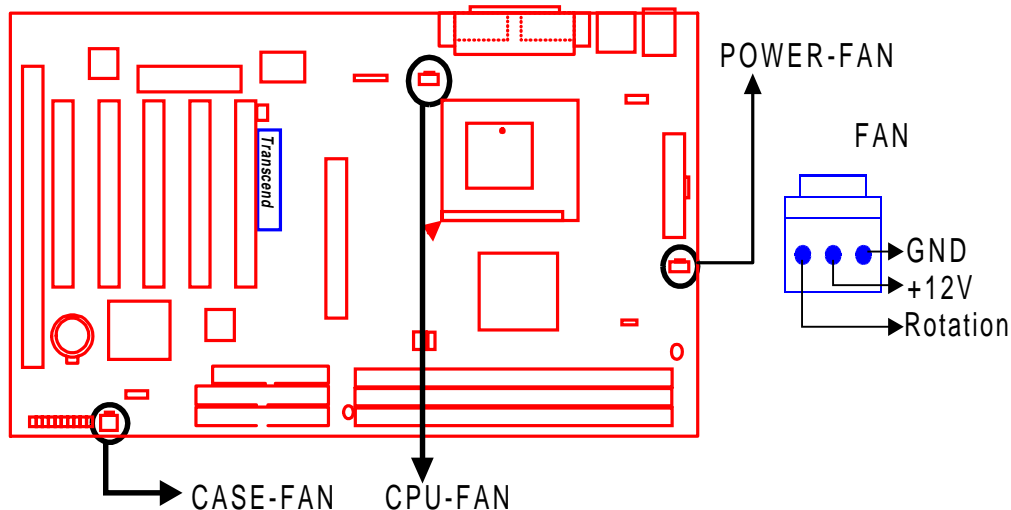

**FAN Connectors**

## 2.10 Wake-on-LAN Connector (3-pin WOL)

This connector connects to LAN cards with a Wake-on-LAN output. The system can be Powered Up when a wakeup packet or signal is received from the LAN card.

**NOTE: This function requires that the “LAN Wake Up” function in the POWER MANAGEMENT SETUP is set to “Enabled” and that your system has an ATX power supply with at least 720mA +5V standby power.**

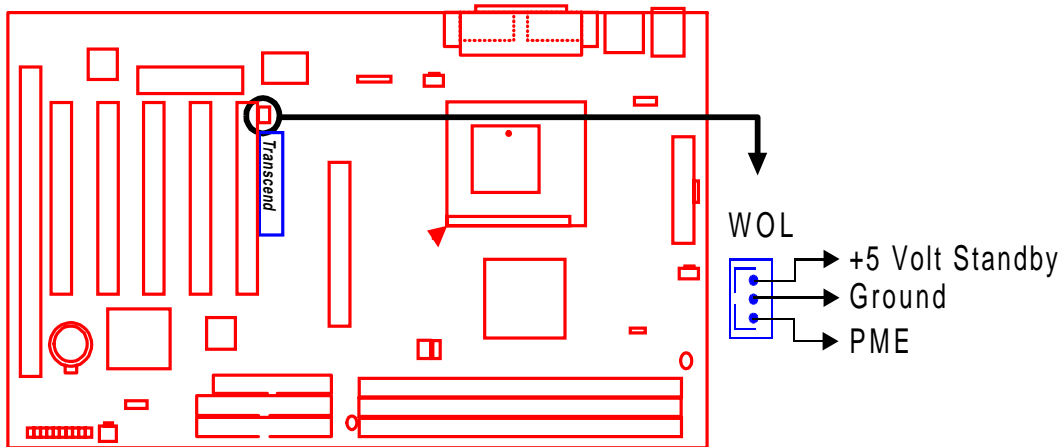

Wake-on-LAN Connector

## 2.11 IrDA-Compliant Infrared Module Connector (5-pin IrDA)

The IrDA connector can be configured to support wireless infrared modules. With this module and application software such as Laplink or Win95 Direct Cable Connection, the user can transfer files to or from laptops(notebooks), PDAs and printers.

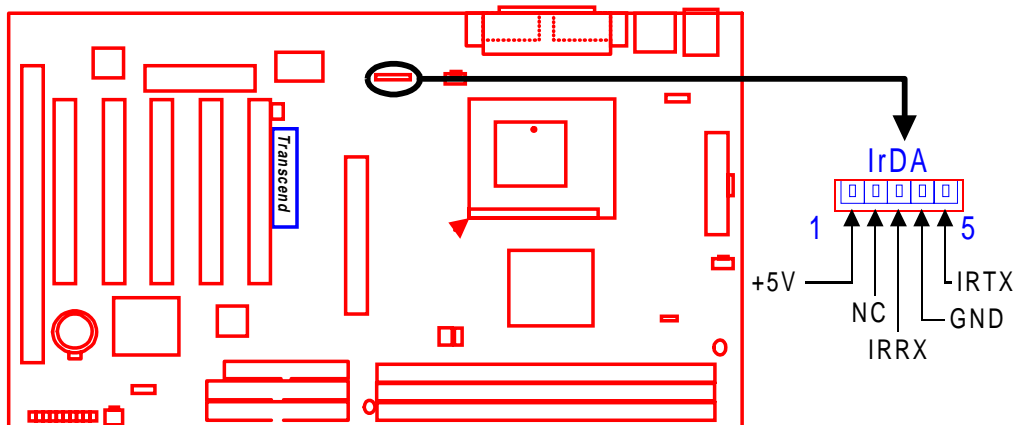

IrDA Connector

## 2.12 Panel Connectors

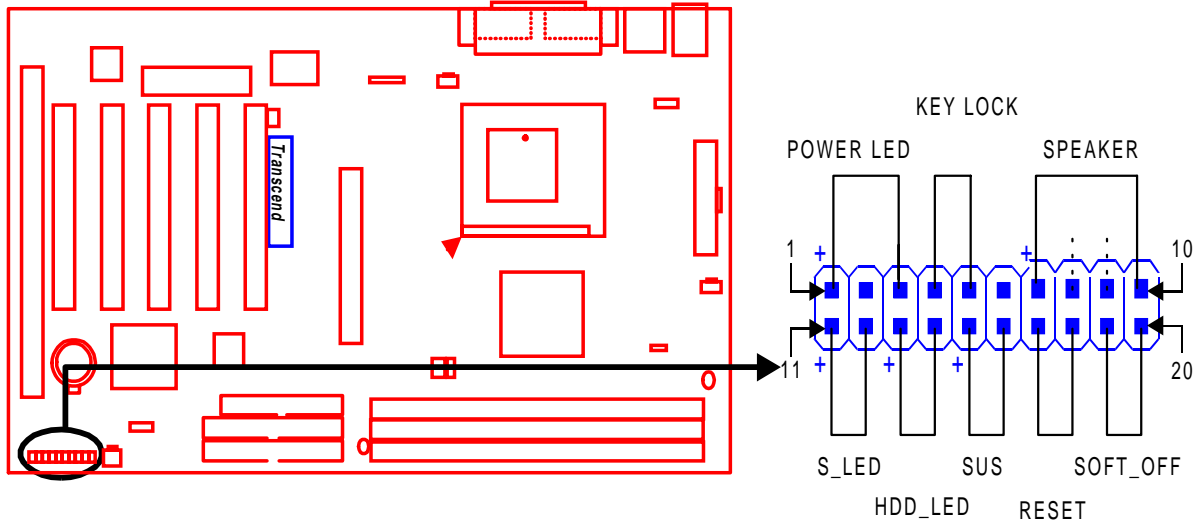

### Panel Connector

#### **Power LED Lead (3-pin POWER LED)**

This 3-pin connector attaches to the power LED.

- Pin1 : +5V
- Pin2 : NC
- Pin3 : GND

#### **Keylock Lead (2-pin KEYLOCK)**

Use the keylock to enable or disable the keyboard.

- Pin4 : KEYLOCK
- Pin5 : GND

#### **Speaker Lead (4-pin SPEAKER)**

This 4-pin connector connects to the case-mounted speaker.

- Pin7 : +5V
- Pin8 : GND
- Pin9 : NC
- Pin10 : SPK

**Suspend Mode LED Lead (2-pin S\_LED)**

The S\_LED will light when the suspend mode works.

Pin11 : +5V

Pin12 : GND

**Harddisk LED Lead (2-pin HDD\_LED)**

This 2-pin connector connects to LED of harddisk. The LED lights when a HDD is active.

Pin13 : +5V

Pin14 : GND

**Reset Switch Lead (2-pin RESET)**

This 2-pin connector connects to the case-mounted reset switch for rebooting your computer without turning off your power switch.

Pin17 : RESET

Pin18 : GND

**Software Power-Off Lead (2-pin SOFT\_OFF)**

Attach the SOFT\_OFF Switch of the panel to this connector.

Pin19 : SOFT-OFF

Pin20 : GND

---

## 2.13 Power Connector (20-pin PWR-CONN)

Make sure to plug the ATX power supply connector to the right direction. The pin definition is shown below. Make sure that your ATX power supply can support at least 720mA on the standby lead.

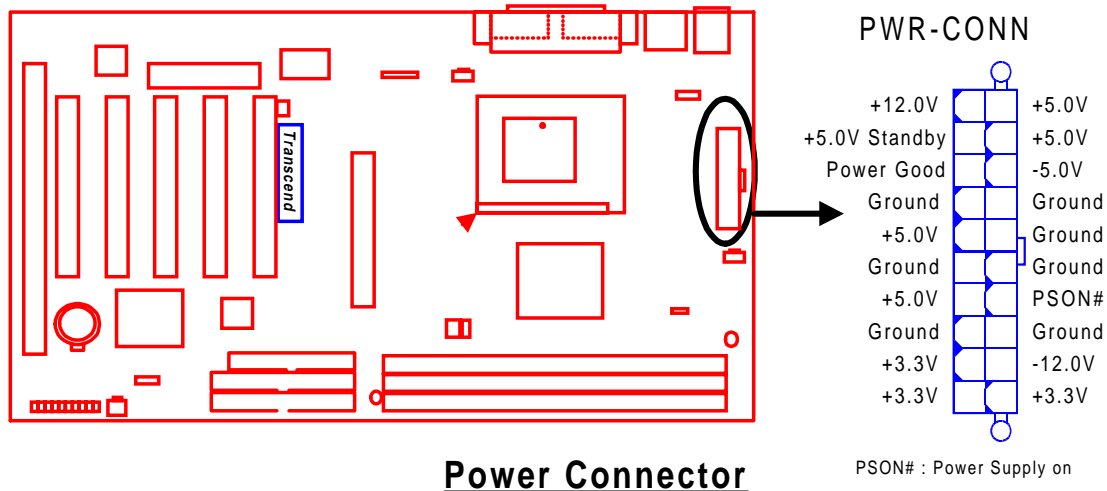

**Power Connector**

## 2.14 External Back Panel I/O Ports

There are 5 kinds of external connectors on the motherboard. **The view angle of drawing shown on next page is from back panel of the housing.**

1. PS/2 Mouse Port (Green, 6-pin MOUSE)

The onboard PS/2 Mouse port is a 6-pin Mini-Din connector marked "MOUSE"

2. PS/2 Keyboard Port (Purple, 6-pin KB)

The onboard PS/2 Keyboard port is a 6-pin Mini-Din connector marked "KB".

3. Universal Serial Bus (USB) Ports 1 & 2 (Black, two 4-pin USBs)

You can attach USB devices to the USB port. The motherboard contains two USB ports, which are marked as "USB".

4. Parallel Port (Burgundy, 25-pin PRN)

The onboard printer port is a 25-pin D-type connector marked "PRN".

5. Serial Ports (Turquoise, two 9-pin COMA/COMB)

The onboard serial ports are 9-pin D-type connectors on the back panel of motherboard.

The serial port 1 is marked as "COMA", and the serial port 2 is marked as "COMB".

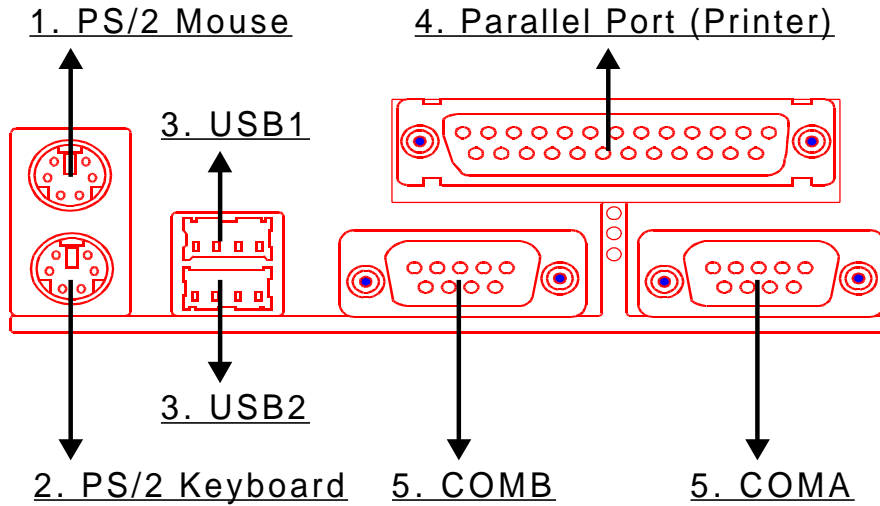

**External Back Panel I/O Ports**

## 2.15 Clearing CMOS Using Jumper (JP4)

To clear the CMOS data, you should turn off your computer power and short pin1 and pin2 of JP4.

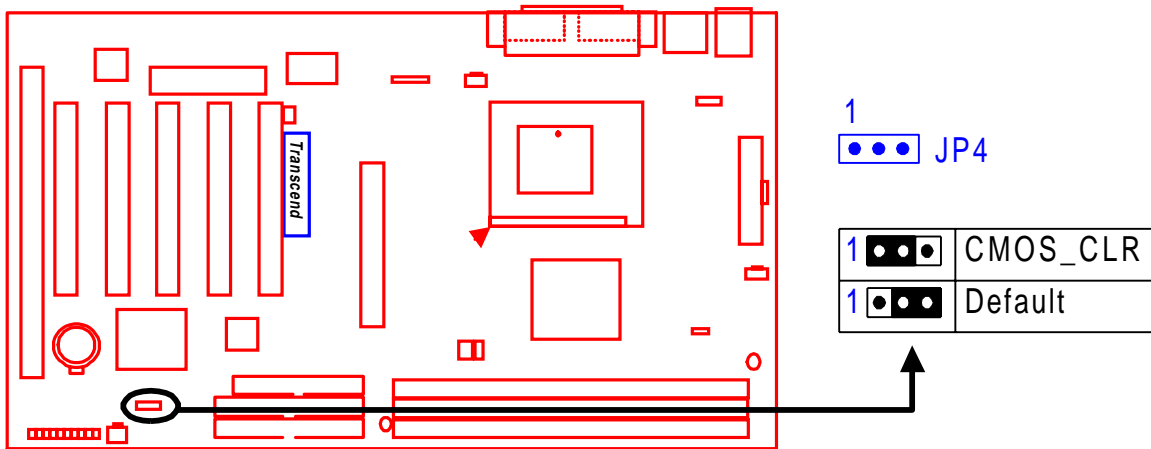

**Jumper to Clear CMOS**

## 2.16 Keyboard Wake Up (3-pin KB-AWK)

This function makes the Keyboard Power Up the system. Set this jumper to “Enable” if you would like your Keyboard to Power Up your computer. Then, go to the “Integrated Peripherals” in the BIOS SETUP MENU (please refer to page 38), and choose the setting you prefer.

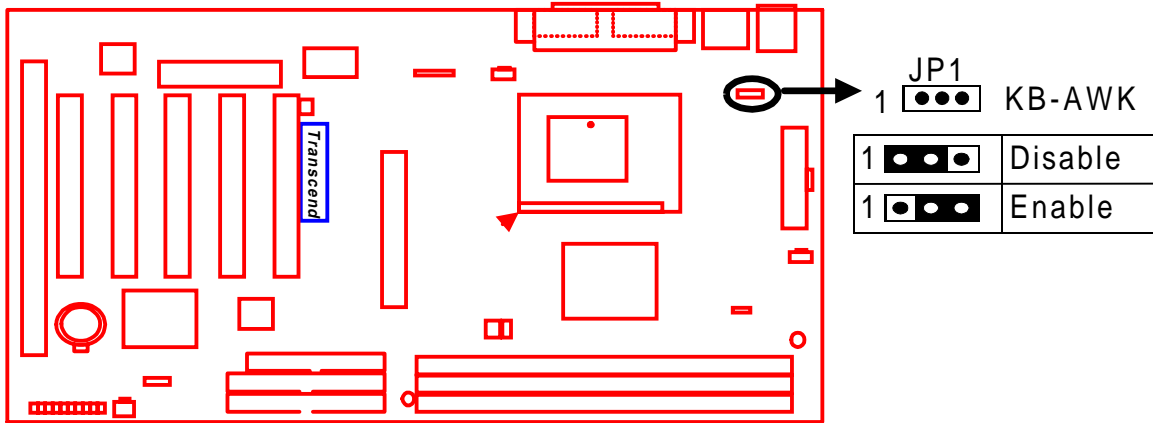

Keyboard Wake Up

## CHAPTER 3 BIOS SETUP

### 3.1 BIOS Setup

Award BIOS has a built-in Setup program that allows users to modify the basic system configuration. This information is stored in CMOS RAM. So it can retain the Setup information when the power is turned off. When the battery of CMOS fails, it will cause the data to be lost. When this happens, you should set up your configuration parameters again after replacing the battery. Please refer to Section 1.1, Essential Handling Precautions (Page 1.)

### 3.2 The Main Menu

As you turn on or reboot the system, the BIOS is immediately activated. It will read the system configuration information, and check the system through Power On Self Test (POST). During the POST process, press the [Del] key, and you can enter the Award BIOS configuration system. The following screen will appear.

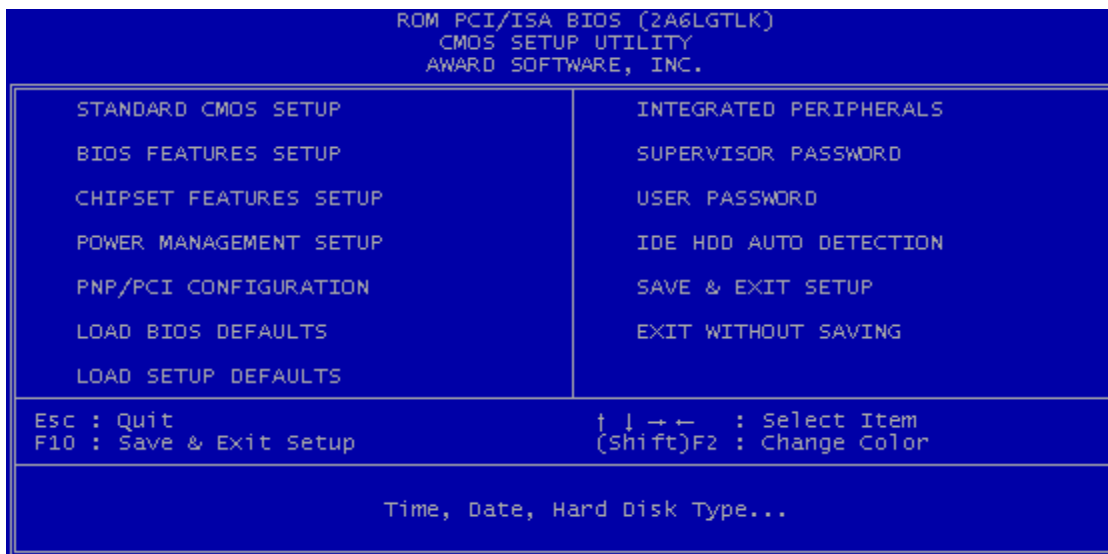

In the Award BIOS system, you can use the arrows ( ↑ ↓ → ← ) to highlight the item, and press the [Enter] key to enter the sub-menu. The following keys help you navigate in Setup.

[Esc] Main Menu: Quit and not save changes into CMOS RAM

Other pages: Exit current page and return to Main Menu

[PgUp] Increase the numeric value or make changes

[PgDn] Decrease the numeric value or make changes

[ + ] Increase the numeric value or make changes

[ - ] Decrease the numeric value or make changes



- [F1] General help, only for Status Page Setup Menu and Option Page Setup Menu
- [F2] Change color from total 16 colors
  - [F2] to select color forward
  - [Shift + F2] to select color backward
- [F3] Calendar, only for Status Page Setup Menu
- [F5] Restore the previous CMOS value from CMOS, only for Option Page Setup Menu
- [F6] Load the default CMOS RAM value from BIOS default table, only for Option Page Setup Menu
- [F7] Load the default
- [F10] Save all the CMOS changes, only for Main Menu

The Following is a brief summary of each setup category.

- **STANDARD CMOS SETUP**

Options in the original PC AT-compatible BIOS

- **BIOS FEATURES SETUP**

Award enhanced BIOS options

- **CHIPSET FEATURES SETUP**

Available options specific to your system chipset

- **POWER MANAGEMENT SETUP**

Advanced Power Management (APM) and Advanced Configuration Power Interface(ACPI) options

- **PNP/PCI CONFIGURATION**

Plug and Play standard and PCI Local Bus configuration options

- **LOAD BIOS DEFAULTS**

BIOS defaults are factory settings for the most stable, minimal-performance system operations

- **LOAD SETUP DEFAULTS**

Setup defaults are factory settings for optimal-performance system operations

- **INTEGRATED PERIPHERALS**

I/O subsystems that depend on the integrated peripherals controller in your system

---

- **SUPERVISOR / USER PASSWORD**

To change, set, or disable a password.

- **IDE HDD AUTO DETECTION**

Automatically detect and configure IDE hard disk parameters.

- **SAVE & EXIT SETUP**

Save settings in nonvolatile CMOS RAM and exit Setup.

- **EXIT WITHOUT SAVING**

Abandon all changes and exit Setup.

## 3.3 Standard CMOS Setup

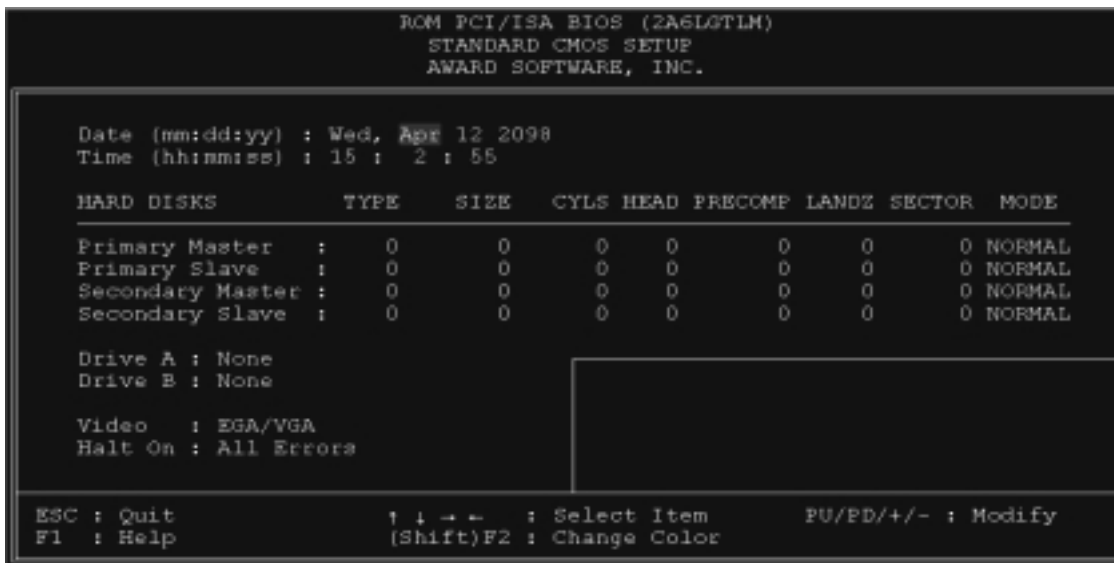

- **Date (mm:dd:yy) / Time (hh:mm:ss)**

Highlight the items and use [PageUp] / [PageDown] to change the value of Date/Time.

- **Primary / Secondary; Master / Slave**

This motherboard can support four IDE devices. We recommend that you set both TYPE and MODE to "AUTO" for all drives. The BIOS can automatically detect the specifications and optimal operating mode of almost all IDE hard drives. When you select "AUTO" for a hard drive, the BIOS detects its specifications during POST while the system boots. If you want to select drive type "AUTO", the other methods of selecting the drive type are also available.

---

1. Match the specifications of your installed IDE hard drive(s) with the preprogrammed values for drive type 1 through 45.
2. Select "USER" and enter values into each drive parameter field.
3. Use the "IDE HDD AUTO DETECTION" function in Main Menu.

Here are the brief explanation of drive specifications.

- TYPE : The BIOS contains a table of pre-defined drive types. Each defined drive type has a specified number of cylinders, number of heads, write precompensation factor, landing zone, and number of sectors. Drives whose specifications do not accommodate any pre-defined type are classified as type "USER".
  - SIZE : Disk drive capacity (approximately). Note that this size is usually slightly larger than the size of a formatted disk given by a disk-checking program.
  - CYLS : Number of cylinders
  - HEAD : Number of heads
  - PRECOMP : Write precompensation cylinder
  - LANDZ : Landing zone
  - SECTOR : Number of sectors
  - MODE : AUTO, NORMAL, LARGE, or LBA
    - AUTO : The BIOS automatically determines the optimal mode.
    - NORMAL : Maximum number of cylinders, heads, and sectors supported are 1024, 16, and 63 respectively.
    - LARGE : For drives that do not support LBA and have more than 1024 cylinders.
    - LBA (Logical Block Addressing) : During drive access, the IDE controller transforms the data address described by sector, head, and cylinder number into a physical block address. This will significantly improve data transfer rates for drives with greater than 1024 cylinders.
-

## • Drive A / Drive B

Select the correct specifications of the diskette drive(s) installed in the computer.

- None : No diskette drive installed.
- 360K, 5.25 in. : 5-1/4 inch standard drive; 360 kilobyte capacity.
- 1.2M, 5.25 in.: 5-1/4 inch high-density drive; 1.2 megabyte capacity.
- 720K, 3.5 in.: 3-1/2 inch double-sided drive; 720 kilobyte capacity.
- 1.44M, 3.5 in.: 3-1/2 inch double-sided drive; 1.44 megabyte capacity.
- 2.88M, 3.5 in.: 3-1/2 inch double-sided drive; 2.88 megabyte capacity.

## • Video

Select the type of primary video subsystem in your computer. The BIOS will detect the correct video type automatically. The BIOS supports a secondary video subsystem, but do not select it in this Setup.

- EGA/VGA : Enhanced Graphics Adapter/Video Graphics Array. For EGA, VGA, SEGA, SVGA or PGA monitor adapters.
- CGA 40 : Color Graphics Adapter, Powers Up in 40-column mode.
- CGA 80 : Color Graphics Adapter, Powers Up in 80-column mode.
- MONO : Monochrome adapter, includes high resolution monochrome adapters.

## • Halt On

During the Power On Self Test (POST), the computer stops if the BIOS detects a hardware error. You can set the BIOS to ignore certain errors during POST and continue the boot-up process. The followings are the selections.

- No Errors : POST does not stop for any error.
  - All Errors : If the BIOS detects any non-fatal error, POST stops and prompts you to take corrective action.
  - All, But Keyboard : If the BIOS detects any non-fatal error except Keyboard, POST stops and prompts you to take corrective action.
  - All, But Diskette : If the BIOS detects any non-fatal error except floppy disk drive, POST stops and prompts you to take corrective action.
  - All, But Disk / Key : If the BIOS detects any non-fatal error except floppy disk drive or keyboard, POST stops and prompts you to take corrective action.
-

## 3.4 BIOS Features Setup

This “BIOS Features Setup” option allows you to improve your system performance and set up system features according to your preference.

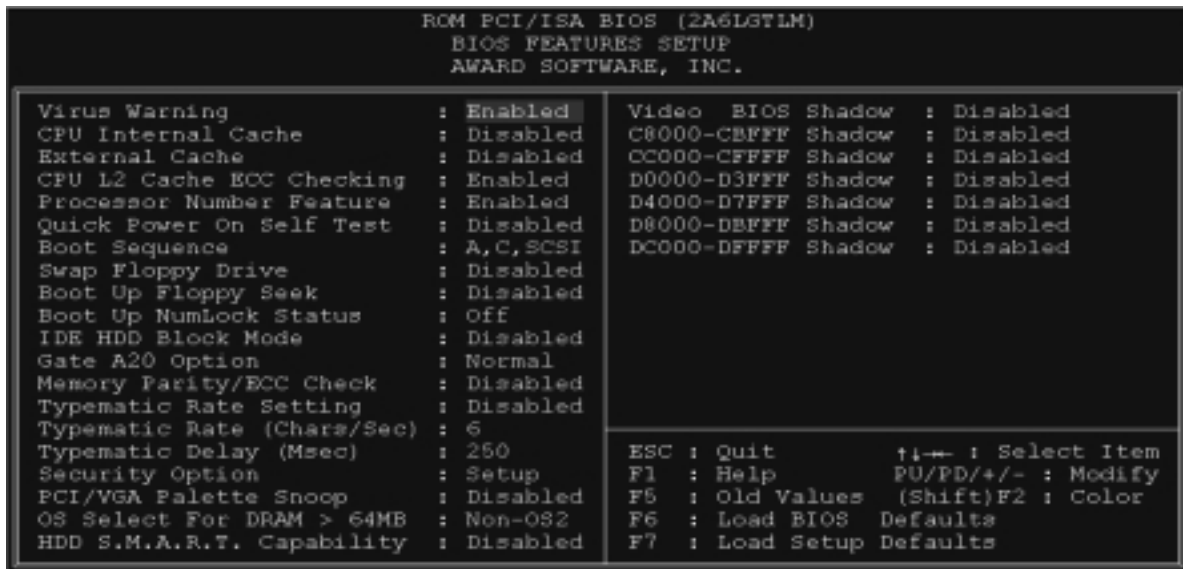

- **Virus Warning**

When the function is enabled, you will receive a warning message if a program (specifically, a virus) attempts to write to the boot sector or the partition table of the hard disk drive. You should then execute an anti-virus program. Keep in mind that this feature protects the boot sector only, not the entire hard drive.

**NOTE: Many disk diagnostic programs that access the boot sector table can trigger the virus warning message. If you plan to run such a program, we recommend that you first disable the virus warning .**

- **CPU Internal Cache / External Cache**

Cache memory is additional memory that is much faster than conventional DRAM (system memory). CPUs from 486-type or up contain internal cache memory. Most, but not all, modern PCs have additional (external) cache memory. When the CPU requests data, the system transfers the requested data from the main DRAM into cache memory for even faster access by the CPU. The External Cache field may not appear if your system does not have external cache memory.

- **CPU L2 Cache ECC Checking**

Select “Enabled” to make sure the data is accurate.

- **Processor Number Feature**

This option is for INTEL Pentium III CPUs, The end-user can choose to open or close it.

- **Quick Power On Self Test**

Select “Enabled” to reduce the amount of time required to run the Power On Self Test (POST). A quick POST skips certain steps. We recommend that you normally disable quick POST. It’s better to find a problem during POST than to lose data during your work.

- **Boot Sequence**

The original IBM PCs loaded the DOS operating system from drive A (floppy disk). So, IBM PC-compatible systems are designed to search for an operating system first on drive A, and then on drive C (hard disk). However, the BIOS now offers 11 different boot sequence options. In addition to the traditional drives “A” and “C”, options include IDE hard drives “D”, “E”, and “F”; plus a “SCSI” hard drive, a “LS” / “ZIP” drive and a CD-ROM drive.

- **Swap Floppy Drive**

This field is effective only in systems with two floppy drives. Selecting “Enabled” assigns physical drive B to logical drive A, and physical drive A to logical drive B.

- **Boot Up Floppy Seek**

While enabled , the BIOS tests (seeks) floppy drives to determine whether they have 40 or 80 tracks. Because very few modern PCs have 40-track floppy drives (360KB), we recommend that you set this field to “Disabled” to save time.

- **Boot Up NumLock Status**

Toggle between “On” and “Off” to control the state of the NumLock key when the system boots. When toggled On, the numeric keypad generates numbers instead of controlling cursor operations.

- **IDE HDD BLOCK MODE**

Block mode is also called Transfer, Multiple Commands or Multiple Sector Read/Write.

- **Gate A20 Option**

Choose “Fast” (default) or “Normal”. “Fast” allows RAM access above 1MB to use the fast gate A20 line.

---

---

- **Memory Parity / ECC Check**

When parity DRAM modules are installed, select “Enabled” to correct 1 bit memory errors in the memory. Otherwise, select “Disabled”.

- **Typematic Rate Setting**

When this function is “Disabled”, the following two items ( “Typematic Rate” and “Typematic Delay” ) are irrelevant. Keystrokes repeat at a rate determined by the keyboard controller in your system. When this function is “Enabled”, you can select a typematic rate and typematic delay.

- **Typematic Rate (Chars / Sec)**

When the typematic rate setting is “Enabled”, you can select a typematic rate (the rate at which characters repeat) when you hold down a key of “6”, “8”, “10”, “12”, “15”, “20”, “24” or “30” characters per second.

- **Typematic Delay (Msec)**

When the typematic delay setting is “Enabled”, you can select a typematic delay (the delay before key strokes begin to repeat) of “250”, “500”, “750” or “1000” milliseconds.

- **Security Option**

If you have set a password, select whether the password is required while the “system” boots, or only when you enter “Setup”.

- **PCI/VGA Palette Snoop**

Some display cards, such as graphics accelerators or MPEG video cards, might not show color properly. Set “Enabled” to correct this problem , or leave this field on “Disabled”.

- **OS Select For DRAM > 64MB**

Select “OS2” only if you are running OS/2 operating system with more than 64 MB of RAM in your system.

- **HDD S.M.A.R.T Capability**

S.M.A.R.T.: Self-Monitoring Analysis and Reporting. If your hard disk supports this function, select “Enabled”.

- **Video BIOS Shadow**

Select “Enabled” to change the video BIOS location from ROM to RAM, where the CPU can read data through the 64-bit DRAM bus. This can enhance system performance.

---

- **C8000-DFFFF Shadow**

You can shadow the ROM on other expansion card by setting these fields. If you install other expansion cards with ROMs, you need to know which address the ROMs use specifically. Shadowing a ROM reduces the memory available between 640K and 1024K depending on the used amount.

### **3.5 Chipset Features Setup**

This option will change the values of the chipset registers and the system setting will alter. Do not change any values if you are not familiar with the chipset.

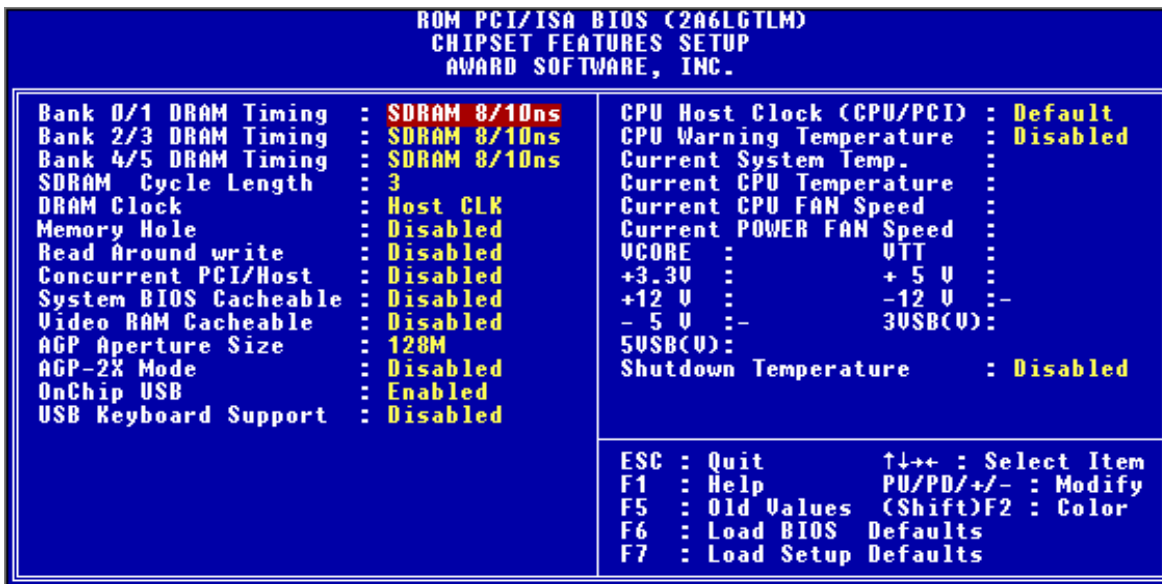

- **Bank 0/1, 2/3, 4/5, DRAM Timing**

The DRAM timing of Bank 0/1, 2/3, 4/5, in this field is set by the system board manufacturer, depending on whether the board has fast paged DRAMs, EDO (extended data output) DRAMs or SDRAMs.

The Choices: “Normal”, “Medium”, “Fast”, “Turbo”, “SDRAM 10ns”, “SDRAM 8ns”.

- **SDRAM Cycle Length**

This controls SDRAM performance; default is “3” clocks. If your SDRAM DIMM specification is 2 CAS latency, change “3” to “2” for better performance.



- **DRAM Clock**

Set the clock frequency of the DRAMs. The default value is “Host Clock”. You can select “HCLK+33M” if your DRAM modules are faster than your CPU (Eg. a 66MHz FSB CPU with PC100 SDRAM, or a 100MHz FSB CPU with PC133 SDRAM); or select “HCLK-33M” for a faster CPU with slower SDRAMs.

- **Memory Hole At 15M-16M**

Enabling this feature reserves memory from 15MB to 16MB for ISA expansion cards that specifically require this setting. This makes the memory from 15MB and up unavailable to the system. Expansion card only access memory up to 16MB. The default is “Disabled” in case the memory size may be reduced to 15MB for some Operation Systems.

- **Read Around Write**

DRAM optimization feature: If a memory read is addressed to a location whose latest write is being held in a buffer before being written to memory, the read is satisfied through the buffer contents, and the read is not sent to the DRAM. The choices: “Enabled” and “Disabled”.

- **Concurrent PCI/Host**

When “Disabled”, the CPU bus will be occupied during the entire PCI operation period.

- **System BIOS Cacheable**

Selecting Enabled allows caching of the System BIOS, resulting in better system performance. However, if any program writes to this memory area, a system error may occur.

- **Video RAM Cacheable**

Selecting “Enabled” allows caching of the video RAM , resulting in better system performance.

- **AGP Aperture Size (MB)**

Select the size of the Accelerated Graphics Port (AGP) aperture. The aperture is a portion of the PCI memory address range dedicated to graphics memory address space. Memory map and graphics data structures can reside in a Graphic Aperture .Host cycles that hit the aperture range are forwarded to the AGP without any translation. See <http://www.agpforum.org/> for AGP information.

- **AGP-2X Mode**

Select “Enabled” to support AGP-2X (clock=133MHz) mode.

---

- **Onchip USB**

Select “Enable”, if you have a USB keyboard or any device.

- **USB Keyboard Support**

Select “Enable”, if you want to use USB keyboard.

- **CPU Host/PCI Clock**

This function allows you to set the FSB frequency of the CPU and the speed of the PCI bus. When JP1 is set to 66MHz, the default FSB is 66MHz, and there are several options under 100MHz available. When JP1 is set to 100MHz, the default FSB is 100MHz, and there are also several options between 100MHz and 133MHz available for you to choose. When JP1 is set to 133MHz, you can select from 124MHz to 150MHz.

**NOTE: If you are not familiar with this feature, we recommend you set this jumper to “AUTO”.**

- **CPU Warning Temperature**

This feature allows you to set the CPU warning temperature. You can choose from “50° C/122° F” to “70° C/158° F” or “Disabled”.

- **Current System Temp**

This field shows the current system Temperature.

- **Current CPU Temperature**

This field shows the current CPU Temperature.

- **Current CPU FAN Speed**

This field will show the CPU fan speed in RPM, if a 3-wire speed controllable fan is installed.

- **Current Power FAN Speed**

This field will show the power fan speed in RPM, if a 3-wire speed controllable fan is installed.

- **Vcore**

This field shows the CPU working voltage.

- **VTT**

This field shows the GTL bus voltage.

---

- **+/- 12V and +/- 5V**

These fields show the working voltage of +/- 12V and +/- 5V on the motherboard.

- **3VSB and 5VSB**

This fields show the standby mode voltage.

- **Shutdown Temperature**

This feature will automatically shutdown the system when the Current CPU Temperature field arrived the setting point you set in this field.

---

## 3.6 Power Management Setup

The Power Management Setup allows you to configure your system to save energy most effectively while operating in manner consistent with your own style of computer use.

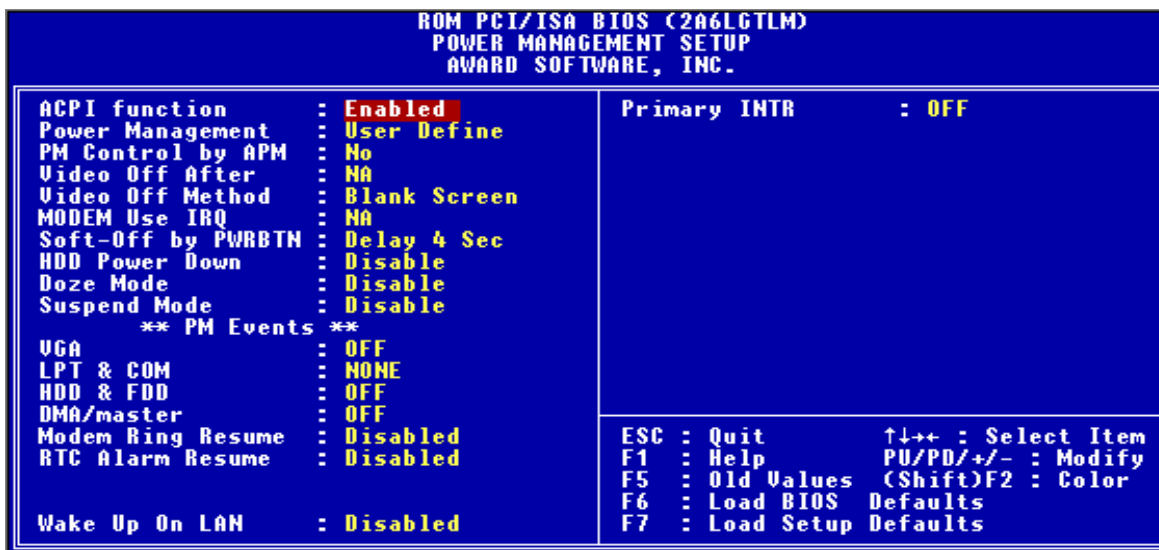

- **ACPI function**

This item allows you to enable /disable the Advanced Configuration and Power Interface (ACPI) functions.

- **Power Management**

This category allows you to select the type (or degree) of power saving and is directly related to the following modes:

1. HDD Power Down
2. Doze Mode
3. Suspend Mode

There are three selections for Power Management. Three of which have fixed mode settings.

1. Min. Power Saving:

Minimum power management mode. Inactivity period is defined as below.

HDD Power Down = 15 min.    Doze Mode = 1 hr.    Suspend Mode = 1 hr.

2. Max. Power Saving:

Maximum power management mode. Inactivity period is defined as below.

HDD Power Down = 1 min.    Doze Mode = 1 min.    Suspend Mode = 1 min.

3. User Defined :

Allow you to set time-out period for each mode shown above individually.

- **PM Control by APM**

When “Yes”, an Advanced Power Management device will be activated to enhance the Max. Power Saving mode and stop the CPU internal clock.

- **Video Off Method**

Determines the manner in which the monitor is blanked.

-V/H SYNC+BLANK : System turns off vertical and horizontal synchronization ports and writes blanks to the video buffer.

-DPMS Support : The DPMS (Display Power Management System ) feature allows the BIOS to control the video display card if it supports this function.

-Blank Screen : System only writes blanks to the video buffer.

- **Video Off After**

Select the power-saving modes during which the monitor goes blank.

-Doze : Monitor remains “on” during Doze modes.

-Suspend : Monitor blanked when system enters Suspend mode.

-N/A : This is default. When system enters power-saving mode, it does not do the video off action.

- **MODEM Use IRQ**

You can select one of the following interrupt resources for MODEM use: “N/A”, “3”, “4”, “5”, “7”, “9”, “10” and “11”.

- **Soft-Off by PWRBTN**

When set to “Instant-off”, the ATX switch can be used as a normal system Power Off button. When set to “Delay 4 sec”, you need to hold the ATX switch for more than 4 seconds to Power Off your system.

Following are three Green PC power saving functions. They are user-configurable only during User Defined Power Management mode.

---

- **HDD Power Down**

After the selected period of driver inactivity(1 to 15 minutes), the hard disk drive will be Power Down while all other devices remain active.

- **Doze Mode**

After the selected period of system inactivity (1 minute to 1 hour), the CPU clock runs at slower speed while all other devices still operate at full speed.

- **Suspend Mode**

After the selected period of system inactivity (1 minute to 1 hour), all devices except the CPU shut off.

**\*\* PM Events \*\***

PM events are I/O events whose occurrence can prevent the system from entering a power saving mode or can awaken the system from such a mode. In effect, the system remains alert for anything which occurs to a device which is configured as "On" even when the system is in power saving mode.

- **VGA**

When set to "On" (default), any event occurring at a VGA port will awaken a system which has been Powered Down.

- **LPT & COM**

When set to "LPT/COM" (default), any event occurring at a COM(serial)/LPT (printer) port will awaken a system which has been Powered Down.

- **HDD & FDD**

When set to "On" (default), any event occurring at a hard or floppy drive port will awaken a system which has been Powered Down.

- **DMA/Master**

When set to On (default), any event occurring at will awaken a system which has been Powered Down.

- **Modem Ring Resume**

This allows either setting of "Enabled" or "Disabled" for Power Up the computer when the MODEM receives a call and the computer is in the soft-off mode.

---

- **RTC Alarm Resume**

This item can Power On your computer at the time you selected.

- **Wake Up On LAN**

This allows you to remotely Power Up your system through your network by sending a wake up frame or signal.

**NOTE: This feature requires the network interface and an ATX power supply with at least 720mA +5 V standby power.**

- **Primary INTR**

When set to “On” (default), any primary interrupt request will awake the system which has been Power Down.

Following is a list of IRQs (Interrupt Requests). You can set each IRQ channel to be “Primary”, “Secondary” or “Disabled”. When set to “Secondary”, the interrupt request will neither prevent the system from going into a power management mode nor awake it.

- IRQ3 (COM2)
- IRQ4 (COM1)
- IRQ5 (LPT2)
- IRQ6 (Floppy Disk)
- IRQ7 (LPT1)
- IRQ8 (RTC Alarm)
- IRQ9 (IRQ2 Redir)
- IRQ10 (Reserved)
- IRQ11 (Reserved)
- IRQ12 (PS/2 Mouse)
- IRQ13 (Coprocessor)
- IRQ14 (Hard Disk)
- IRQ15 (Reserved)

## **3.7 PnP/PCI Configuration Setup**

This section describes configuring the PCI bus system. PCI (Personal Computer Interconnect) is a system which allows I/O devices to operate at speeds nearing the speed that CPU itself uses when communicating with its own special components. This section covers some very technical items and it is strongly recommended that only experienced users change the configuration.

```

ROM PCI/ISA BIOS (2A6LGLTK)
PNP/PCI CONFIGURATION
AWARD SOFTWARE, INC.

PnP OS Installed      : No
Resources Controlled By : Manual
Reset Configuration Data : Disabled

IRQ-3 Assigned to : PCI/ISA PnP
IRQ-4 Assigned to : PCI/ISA PnP
IRQ-5 Assigned to : PCI/ISA PnP
IRQ-7 Assigned to : PCI/ISA PnP
IRQ-9 Assigned to : PCI/ISA PnP
IRQ-10 Assigned to : PCI/ISA PnP
IRQ-11 Assigned to : PCI/ISA PnP
IRQ-12 Assigned to : PCI/ISA PnP
IRQ-14 Assigned to : PCI/ISA PnP
IRQ-15 Assigned to : PCI/ISA PnP
DMA-0 Assigned to : PCI/ISA PnP
DMA-1 Assigned to : PCI/ISA PnP
DMA-3 Assigned to : PCI/ISA PnP
DMA-5 Assigned to : PCI/ISA PnP
DMA-6 Assigned to : PCI/ISA PnP
DMA-7 Assigned to : PCI/ISA PnP

CPU to PCI Write Buffer : Enabled
PCI Dynamic Bursting   : Enabled
PCI Master 0 WS Write  : Enabled
PCI Delay Transaction  : Enabled
PCI#2 Access #1 Retry  : Disabled
AGP Master 1 WS Write  : Enabled
AGP Master 1 WS Read   : Disabled

Assign IRQ For USB    : Disabled
Assign IRQ For VGA    : Disabled

ESC : Quit           ↑↓←→: Select Item
F1  : Help           PU/PD/+/- : Modify
F5  : Old Values    (Shift)F2 : Color
F6  : Load BIOS Defaults
F7  : Load Setup Defaults

```

- **PnP OS Installed**

This field allows you to use a Plug-and-Play (PnP) operating system to configure the PCI bus slots instead of using the BIOS. Thus interrupts may be re-assigned by the OS when “Yes” is selected. When a non-PnP OS is installed to prevent re-assigning of interrupt settings, select the default setting of “No”.

- **Resource Controlled by**

The Award Plug and Play BIOS can automatically configure all the boot and Plug and Play(PnP) compatible devices. If you select “Auto”, all the interrupt request (IRQ) and DMA assignment fields disappear, as the BIOS automatically assigns them.

- **Reset Configuration Data**

Normally, you leave this field “Disabled”. Select “Enabled” to reset Extended System Configuration Data (ESCD) when you exit “Setup”, if you have installed a new add-on and the system reconfiguration has caused such a serious conflict that the operating system cannot boot.

- **IRQ-n Assigned to**

When resources are controlled manually, assign each system interrupt as one of the following types, depending on the type of device using the interrupt.

- Legacy ISA Devices, requiring a specific interrupt (such as IRQ4 for serial port1), compliant with the original PC AT bus specification.



- PCI/ISA PnP devices, whether designed for PCI or ISA bus architecture, compliant with the Plug and Play standard.

- **DMA-n Assigned to**

When resources are controlled manually, assign each system a DMA channel as one of the following types, depending on the type of device using the DMA.

- Legacy ISA Devices, requiring a specific DMA channel, compliant with the original PCAT bus specification.

- PCI/ISA PnP devices, whether designed for PCI or ISA bus architecture, compliant with the Plug and Play standard.

- **CPU to PCI Write Buffer**

When “Enabled”, up to four Dword of data can be written to the PCI bus without waiting for the PCI bus finish. When “Disabled”, a write buffer is not used and the CPU must wait after each write cycle until the PCI bus signals that it is ready to receive more data.

- **PCI Dynamic Bursting**

When “Enabled”, every write transaction goes to the write buffer. Burstable transactions then burst on the PCI bus and nonburstable transactions will write to PCI bus immediately.

- **PCI Master 0 WS Write**

When “Enabled”, writes to the PCI bus are executed with zero wait states.

- **PCI Delay Transaction**

The chipset has an embedded 32-bit posted write buffer to support delay transactions cycles. Select “Enabled” to support compliance with PCI specification version 2.1.

- **PCI #2 Access #1 Retry**

Select “Enabled” to support PCI #2 (AGP bus) access to PCI #1 (PCI bus) retry function when a error occurred. The default value is “Disabled”.

- **AGP Master 1 WS Write**

Selecting “Enabled” will implement a single delay when writing to the AGP Bus. By default, two wait states are used by the system, allowing for greater stability.

- **AGP Master 1 WS Read**

This implements a single delay when reading to the AGP Bus. By default, two-wait states are used by the system, allowing for greater stability.

---

- **Assign IRQ For USB**

When “Enabled”, BIOS will assign an IRQ channel for USB controller.

- **Assign IRQ For VGA**

Select “Enabled” only if your VGA card requires an assigned IRQ. Most ordinary cards do not; but some high-end cards with video capture function do. Consult your VGA documentation to set this field. Activity of the selected IRQ always awakens the system.

### **3.8 Integrated Peripherals**

The Integrated Peripherals changes the value of I/O chipset registers. These registers control the system options in the computer.

```

ROM PCI/ISA BIOS (2A6LGTLM)
INTEGRATED PERIPHERALS
AWARD SOFTWARE, INC.

OnChip IDE Channel0 : Disabled
OnChip IDE Channel1 : Disabled
IDE Prefetch Mode   : Disabled

Init Display First  : PCI Slot

POWER ON Function  :
KB Power ON Password : Enter
Hot Key Power ON   : Ctrl-F1
KBC Input Clock    : 6 MHz
Onboard FDC Controller: Disabled
Onboard Serial Port 1 : Disabled
Onboard Serial Port 2 :

UART Mode Select   :
UART2 Duplex Mode  : Full
RxD , TxD Active   : Hi,Hi
IR Transmission Delay : Disabled
Onboard Parallel Port :
Parallel Port Mode :
ECP Mode Use DMA   : 1
EPP Mode Select    : EPP1.9

PWRON After PWR-Fail : Off

ESC : Quit           ↑↓↓+ : Select Item
F1  : Help           PU/PD/+/- : Modify
F5  : Old Values (Shift)F2 : Color
F6  : Load BIOS Defaults
F7  : Load Setup Defaults

```

- **OnChip IDE Channel 0/1**

Select “Enabled” to activate the first and/or second onboard IDE interface. Select “Disabled” to deactivate an onboard interface, if you install a primary and/or secondary **add-in** IDE interface.

- **IDE Prefetch Mode**

The onboard IDE drive interfaces supports IDE prefetching, for faster drive accesses. If you install a primary and/or secondary add-in IDE interface, set this field to “Disabled” if the interface does not support prefetching.

- **Primary/Secondary Master/Slave PIO**

The four IDE PIO (Programmed Input/Output) fields let you set a PIO mode (0-4) for each of the four IDE devices that the onboard IDE interface supports. Modes 0 through 4 provide successively increased performance. In “Auto” mode, the system automatically determines the best mode for each device.

- **Primary/Secondary Master/Slave UDMA**

Ultra DMA/33/66 implementation is possible only if your IDE hard drive can support and the operating environment includes a DMA driver (Windows 95 OSR2 or a third-party IDE bus master driver). If your hard disk drive and your system software can both support Ultra DMA/33/66, select “Auto” to enable BIOS support.

- **Init Display First**

This item allows you to decide whether to activate “PCI Slot” display card or “AGP” display card first.

- **Power On Function**

- Button only : Power On only by pushing button on the case (Default).
- Keyboard 98 : You can Power On system by pushing Power-On key of keyboard 98.
- Password : Power On only if you key in correct password.
- Hot KEY : You can choose a hot key to Power On the system.
- Mouse [Left] : Power On system by double clicking the Mouse left button.
- Mouse [Right] : Power On system by double clicking the Mouse right button.

- **KB Power On Password**

Enter the Power On password here.

- **Hot Key Power On**

Choose a hot key from [Ctrl]+[F1] to [Ctrl]+[F12].

- **KBC Input Clock**

Select the following frequency for the Keyboard controller input clock:

- 6MHz    • 8MHz    • 12MHz    • 16MHz
-

- **Onboard FDC Controller**

You can use this function to enable or disable the onboard FDC controller.

- **Onboard Serial Port 1/Port 2**

Select an address and the corresponding interrupt for each of the first and second serial ports. The choice: “3F8/IRQ4”, “2F8/IRQ3”, “3E8/IRQ4”, “2F8/IRQ3”, “Disabled” and “Auto”.

**The second serial port shares resources (address and IRQ) with IrDA.**

- **UART Mode Select**

Choose the right type of the infrared device:

- Normal : Normal operation
- IrDA : IrDA compliant serial infrared port
- ASKIR : Amplitude shift keyed infrared port

- **UART2 Duplex Mode**

Consult your IR peripheral documentation to set this field.

- **RxDx , TxD Active**

Consult your IR peripheral documentation to set this field.

- **IR Transmission Delay**

Consult your IR peripheral documentation to set this field.

- **Onboard Parallel Port**

Select a logical LPT port name and matching address for the physical parallel (printer) port. The choice: “378H/IRQ7”, “278H/IRQ5”, “3BCH/IRQ7” or “Disabled”.

- **Parallel Port Mode**

This field allows you to set the operation mode of the parallel port. The setting “SPP”, allows normal-speed operation but in one direction only; “EPP” allows bi-directional parallel port operation at maximum speed; “ECP” allows the parallel port to operate in bi-directional mode and at a speed faster than the maximum data transfer rate; “ECP+EPP” allows normal speed operation in a two-way mode.

- **ECP Mode Use DMA**

This selection is available only if you select “ECP” or “ECP+EPP” in the Parallel Port Mode. Select either DMA Channel “1” or “3”.

---

- **EPP Mode Select**

There are two versions 1.7 and 1.9, available for EPP Mode. When setting the version, check if the device connected to the parallel port needs the specified version or not. If not, it's recommended to select version 1.9.

- **PwrOn After PWR-Fail**

Turning on this function will automatically power on the system after a power fail.

### 3.9 Supervisor Password

Passwords prevents unauthorized use of your computer. If you set a password, the system prompts for the correct password before you boot or access "Setup"

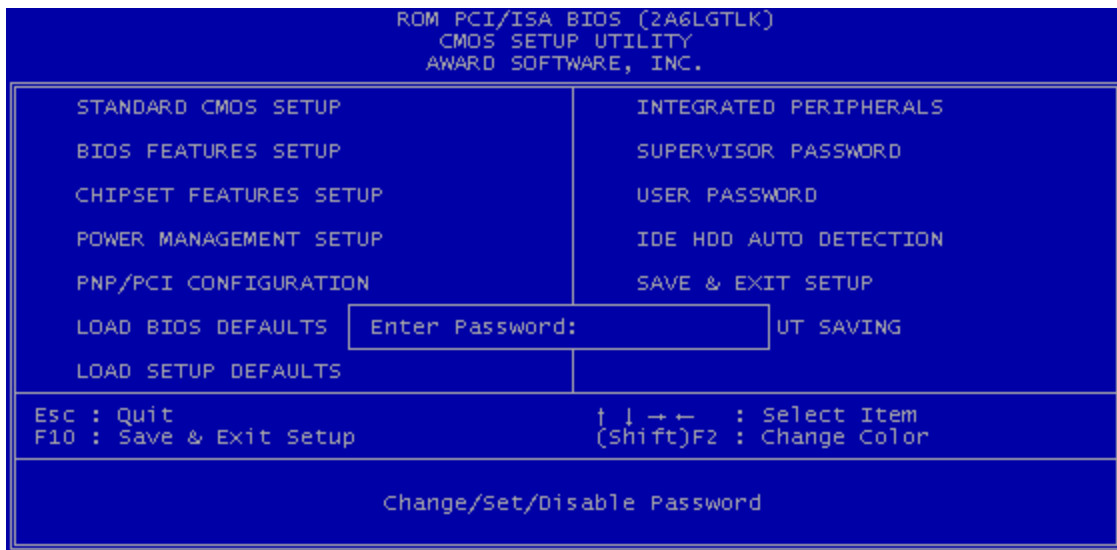

**To set a password:**

1. At the prompt, type your password. Your password can be up to 8 alphanumeric characters. When you type the characters, they appear as asterisks ( \* ) on the password screen box.
2. After typing the password, press [Enter] key.
3. At the next prompt, re-type your password and press [Enter] key again to confirm the new password. After the password entry, the screen automatically reverts to the main screen.

**To disable the password:**

Press [Enter] key when prompted to enter the password. The screen displays a message confirming that the password has been disabled.

## 3.10 User Password

This option allows you to a set the password to prevent others from changing the BIOS setting of your system. This operation is the same as Supervisor Password.

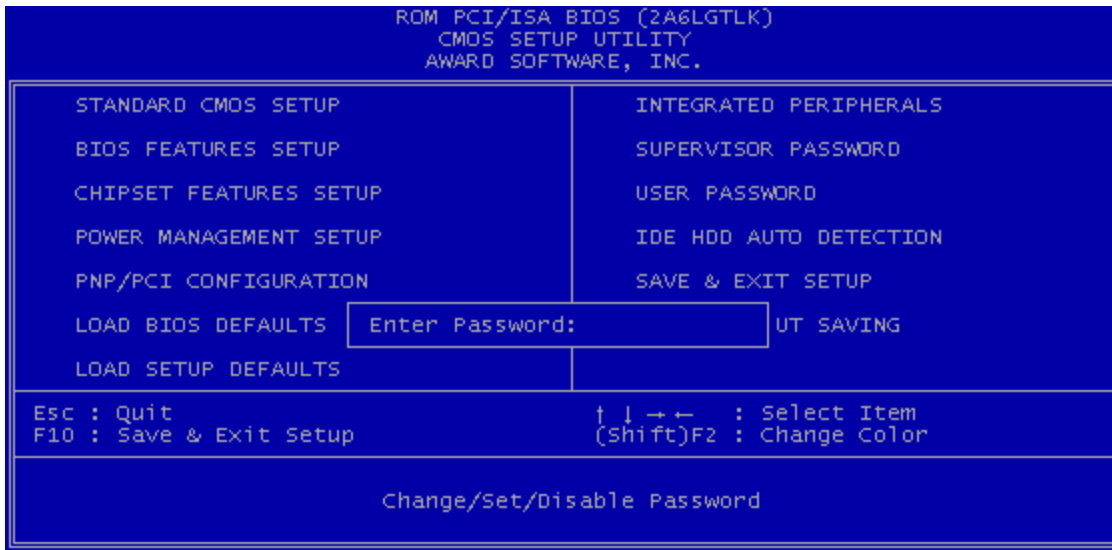

## 3.11 IDE HDD Auto Detection

Use the BIOS utility to detect the HDD type automatically. Press “Y” to accept, “N” to reject, and “ESC” to the next detection.

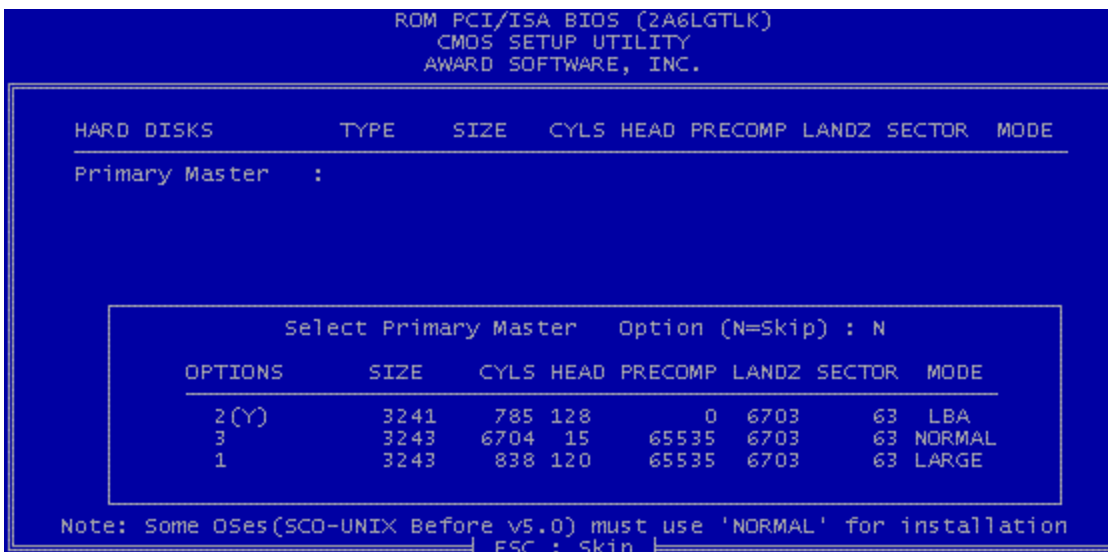

## 3.12 Save & Exit Setup

Save the setting and exit the BIOS utility.

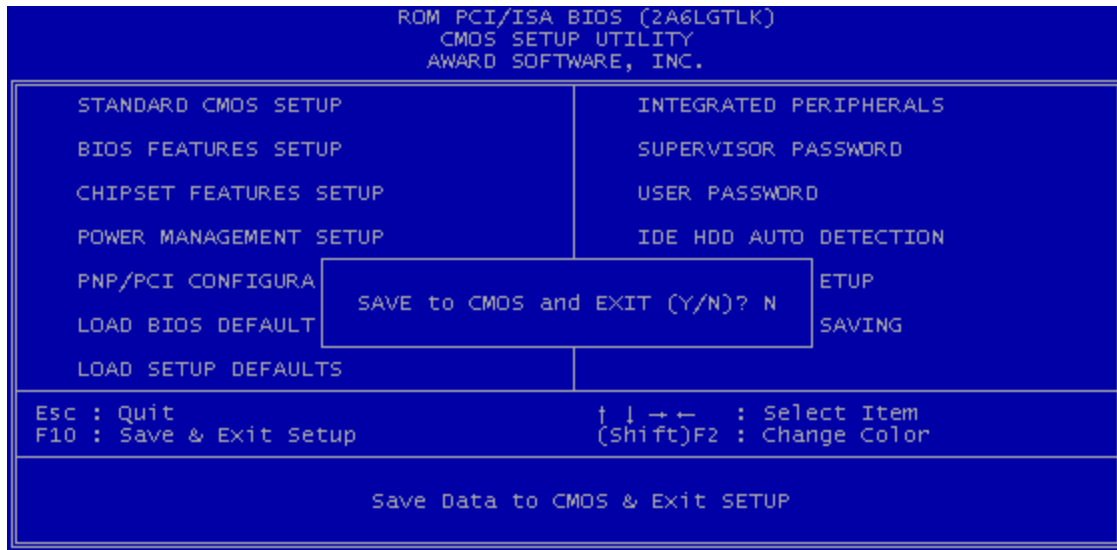

## 3.13 Exit Without Saving

Abort the current change and exit the BIOS utility.

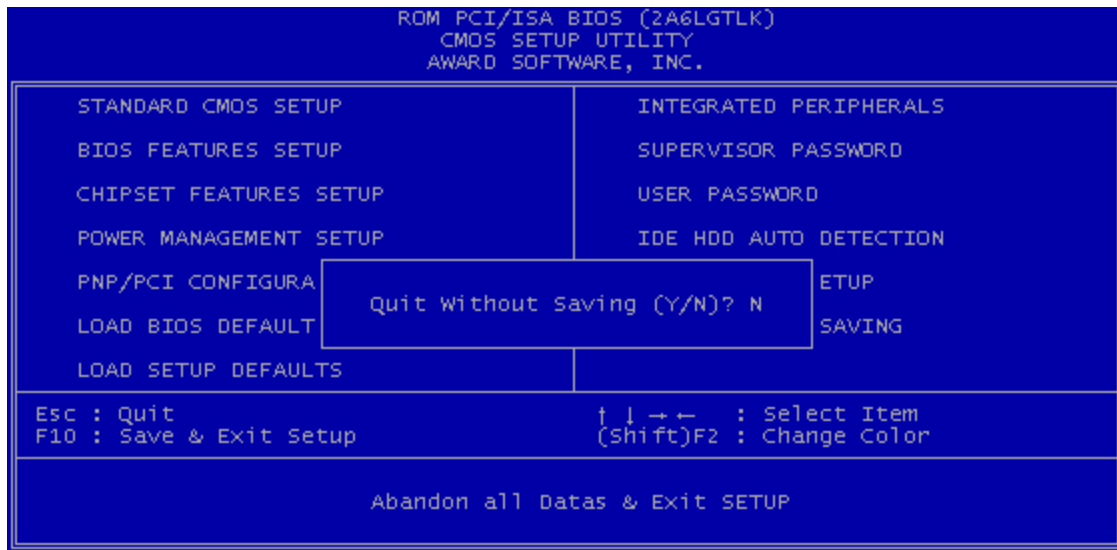

## 3.14 Load BIOS Defaults

**NOTE:** This option allows you to load the troubleshooting default values permanently stored in the BIOS ROM. These default settings are non-optimal and disable all high performance features.

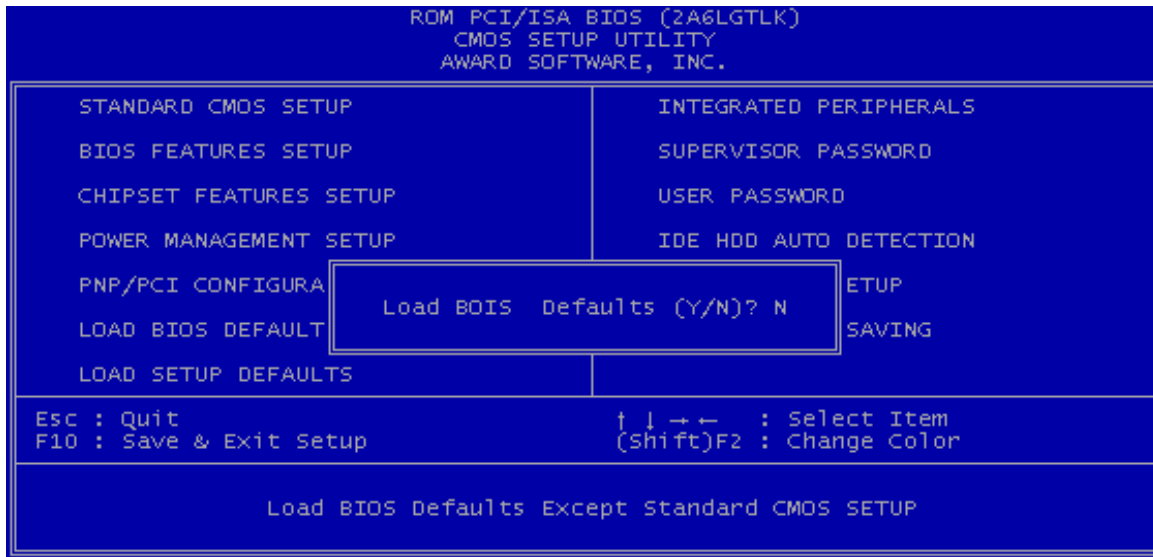

## 3.15 Load Setup Defaults

This option allows you to load the default values to the system configuration fields. These default values are the optimized configuration settings for the system.

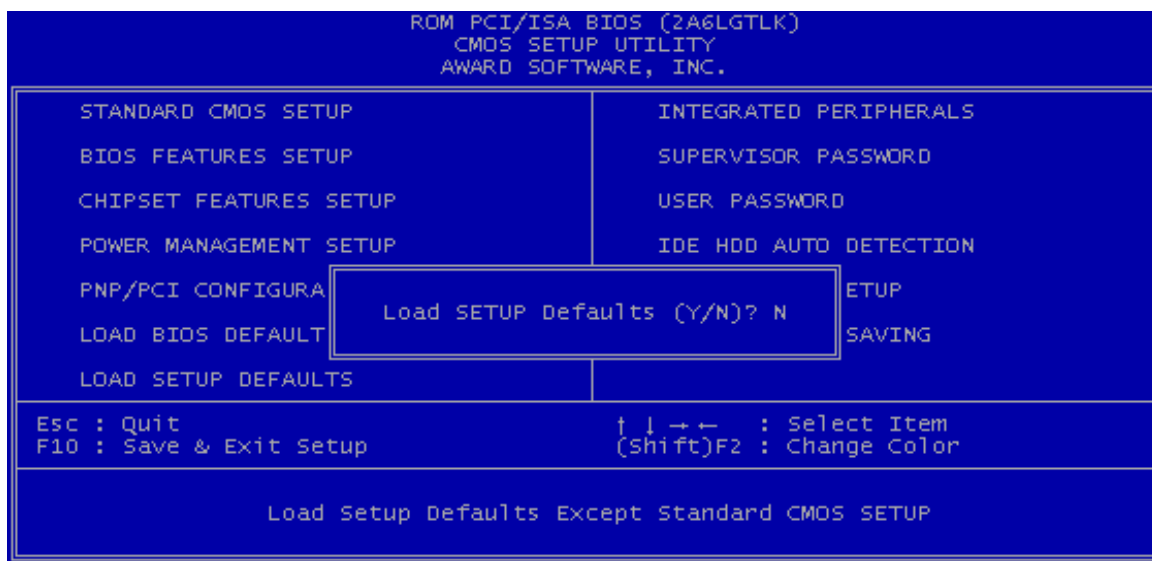



## CHAPTER 4 BIOS UPGRADE

### 4.1 How to Check Your BIOS File Name and Version

Please turn on PC first, the screen will display as follows :

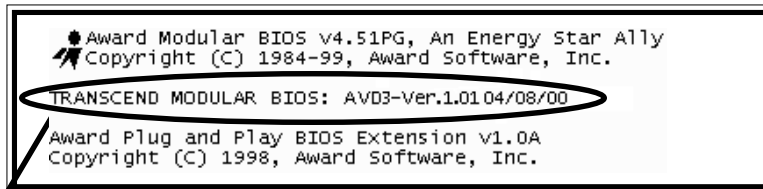

#### TRANSCEND MODULAR BIOS : AVD3-Ver.1.01

You can see a description shown on the third line.

#### AVD3 - Ver.1.01

- BIOS Version 1.01  
(You can upgrade to a newer version if your BIOS version is older than this version.)
- BIOS File Name  
(Make sure the first 5 characters are the same as your own version if you want to upgrade your BIOS.)

### 4.2 Downloading the Correct BIOS File from the Transcend Web Site

Please enter Transcend web site : <http://www.transcendusa.com/>

Choose BIOS upgrade environment.

The BIOS file name consists of 5 characters. Check the exact BIOS to download. Your BIOS file name must absolutely match the one shown on our web. Then download the suitable version to your disk

**Warning: Your system could be damaged, if a wrong BIOS version is accidentally used. If you are not sure what version you should choose, please contact us at [techsupport@transcend.com.tw](mailto:techsupport@transcend.com.tw)**

## 4.3 How to Upgrade Your Motherboard BIOS

Please follow these 5 steps listed below to update your BIOS.

Step 1: Make a record of your original or existing BIOS Setup parameters.

- Press [Del] during the power On self Test to enter BIOS Setup Program when you start your system.
- Write down the value of each parameter in order to re-configure your system after BIOS updating.

Step 2: Make a system Disk

- Put a clean 3.5" disk in Drive A

MS-DOS:Key in **FORMAT A:/s** and press [Enter].

Windows O/S: Select the icon of [My Computer]

Click [3.5" Floppy (A:)]

Select [File/Format] from Command Bar

Under **Format 3.5** Floppy (A:) **Menu** Select

Format type = Full item and

Other Options = Copy system files

Click [Start] button

Step 3: Download the updated BIOS EXE file from the web site to a floppy disk.

(Ref 4.1 and 4.2)

Step 4: Execute the download file to decompress it.

Step 5: Please read the file of Readme.TXT carefully, and follow the instructions step by step. Then you can finish the BIOS update.

