

TravelMate 340

Service Guide

Service guide files and updates are available on the AIPG/CSD web; for more information, please refer to <http://csd.acer.com.tw>

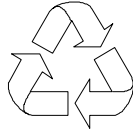

100% Recycled Paper

PART NO.: 49.40F02.001
DOC. NO.: SG322-9910A

PRINTED IN TAIWAN

Copyright

Copyright © 1999 by Acer Incorporated. All rights reserved. No part of this publication may be reproduced, transmitted, transcribed, stored in a retrieval system, or translated into any language or computer language, in any form or by any means, electronic, mechanical, magnetic, optical, chemical, manual or otherwise, without the prior written permission of Acer Incorporated.

Disclaimer

The information in this guide is subject to change without notice.

Acer Incorporated makes no representations or warranties, either expressed or implied, with respect to the contents hereof and specifically disclaims any warranties of merchantability or fitness for any particular purpose. Any Acer Incorporated software described in this manual is sold or licensed "as is". Should the programs prove defective following their purchase, the buyer (and not Acer Incorporated, its distributor, or its dealer) assumes the entire cost of all necessary servicing, repair, and any incidental or consequential damages resulting from any defect in the software.

Acer is a registered trademark of Acer Corporation.

Intel is a registered trademark of Intel Corporation.

Pentium and Pentium II/III are trademarks of Intel Corporation.

Other brand and product names are trademarks and/or registered trademarks of their respective holders.

Conventions

The following conventions are used in this manual:

Screen messages	Denotes actual messages that appear on screen.
NOTE	Gives bits and pieces of additional information related to the current topic.
WARNING	Alerts you to any damage that might result from doing or not doing specific actions.
CAUTION	Gives precautionary measures to avoid possible hardware or software problems.
IMPORTANT	Reminds you to do specific actions relevant to the accomplishment of procedures.

Preface

Before using this information and the product it supports, please read the following general information.

1. This Service Guide provides you with all technical information relating to the BASIC CONFIGURATION decided for Acer's "global" product offering. To better fit local market requirements and enhance product competitiveness, your regional office MAY have decided to extend the functionality of a machine (e.g. add-on card, modem, or extra memory capability). These LOCALIZED FEATURES will NOT be covered in this generic service guide. In such cases, please contact your regional offices or the responsible personnel/channel to provide you with further technical details.
2. Please note WHEN ORDERING FRU PARTS, that you should check the most up-to-date information available on your regional web or channel. If, for whatever reason, a part number change is made, it will not be noted in the printed Service Guide. For ACER-AUTHORIZED SERVICE PROVIDERS, your Acer office may have a DIFFERENT part number code to those given in the FRU list of this printed Service Guide. You MUST use the list provided by your regional Acer office to order FRU parts for repair and service of customer machines.

Chapter 1	System Specifications	1
	Features	1
	System Block Diagram	3
	Board Layout	4
	Panel	6
	Left Panel	6
	Rear Panel	6
	Right Panel	8
	Indicators	11
	Keyboard	12
	Hardware Configuration and Specification	14
Chapter 2	System Utilities	25
	BIOS Setup Utility	25
	Navigating the BIOS Utility	25
	System Information	26
	Basic System Settings	27
	Startup Configuration	27
	Onboard Devices Configuration	29
	System Security	30
	Power Management	32
	Load Default Settings	33
	Flash Utility	34
	Executing Flash Program	34
	System Utility Diskette	35
	Panel ID Utility	35
	Thermal and Fan Utility	35
	Main Board Data Utility	35
	System Diagnostic Diskette	36
	Running PQA Diagnostics Program	37
Chapter 3	Machine Disassembly and Replacement	39
	General Information	40
	Before You Begin	40
	Disassembly Procedure Flowchart	41
	Removing the Battery Pack	43
	Removing the Hard Disk Drive Module	44
	Disassembling the Hard Disk Drive Module	44
	Removing the External DIMM Module	45
	Removing the LCD Module	46
	Removing the Middle Cover	46
	Removing the Speaker	46
	Disassembling the LCD module	46
	Disassembling the Main Unit	49
	Removing the Keyboard	49
	Removing the DIMM Module	49
	Removing the Modem Combo Board	49
	Removing the RTC	50
	Removing the Lower Case	50
	Removing the Main Board	51
	Removing the Touchpad Board	52

Table of Contents

Chapter 4	Troubleshooting	53
	System Check Procedures	54
	External Diskette Drive Check	54
	External CD-ROM Drive Check	54
	Keyboard or Auxiliary Input Device Check	54
	Memory Check	55
	Power System Check	55
	Touchpad Check	56
	Power-On Self-Test (POST) Error Message	57
	Index of Error Messages	58
	Index of Symptom-to-FRU Error Message	60
	Intermittent Problems	63
	Undetermined Problems	63
	Index of AFlash BIOS Error Message	64
	Index of PQA Diagnostic Error Code, Message	64
Chapter 5	Jumper and Connector Information	65
	Top View	65
	Bottom View	66
Chapter 6	FRU (Field Replaceable Unit) List	67
Appendix A	Model Number and Configurations	77
Appendix B	Test Compatible Components	79
	Windows 95 Environment Test	80
	Windows 98 Environment Test	81
	Windows 2000 Environment Test	82
	Windows NT 4.0 Environment Test	83
Appendix C	Online Support Information	85
Index		87

System Specifications

Features

This computer was designed with the user in mind. Here are just a few of its many features:

Performance

- Intel Pentium® III 450/500 processor with integrated L2 cache memory
- 64-bit main memory
- Large and vibrant Thin-Film-Transistor (TFT) SVGA Liquid Crystal Display (LCD)
- 64-bit graphics acceleration with 2.5MB graphics memory and Accelerated Graphics Port (AGP)
- High-capacity, Enhanced-IDE removable hard disk
- External EasyLink™ Combo Drive (floppy drive + CD-ROM or DVD-ROM drive “combo”)
- Lithium-Ion battery pack
- Power management system with ACPI (Advanced Configuration and Power Interface) or APM (Advanced Power Management) support

Multimedia

- 16-bit high-fidelity PCI stereo audio with 3D sound and wavetable synthesizer
- Built-in speaker
- EasyLink™ Combo Drive (CD-ROM or DVD-ROM)
- Dual view capability
- DVD playback capability (with DVD-equipped EasyLink™ DVD Combo Drive option)
- USB video capture kit

Connectivity

- High-speed fax/data PCI modem
- Built-in network feature for Ethernet 10/1000 LAN --- optional
- Fast infrared (FIR) wireless communication
- Universal Serial Bus (USB) port

Human-centric Design and Ergonomics

- Ultra-slim, sleek, smooth and stylish design
- Full-sized keyboard
- Wide and curved palm rest
- Ergonomically-centered touchpad pointing device with scroll function
- Stylish cover accessory

Expansion

- CardBus PC Card (formerly PCMCIA) slot (one type II/I) with Zoomed Video (ZV) support
- Upgradeable memory and hard disk

Display

The large graphics display offers excellent viewing, display quality and desktop performance graphics. The computer supports a Thin-Film Transistor (TFT) liquid crystal display (LCD) displaying 32-bit true-color at 800x600 Super Video Graphics Array (SVGA) resolution.

Video Performance

PCI local bus video with 64-bit graphics acceleration and 2.5MB high-speed Synchronous Graphics Random Access Memory (SGRAM) boost video performance. The video also includes 3D capabilities such as Goraud shading, and Z-buffering, as well as DVD playback support.

Simultaneous Display

The computer's large display and multimedia capabilities are great for giving presentations. If you prefer, you can also connect an external monitor when giving presentations. This computer supports simultaneous LCD and CRT display. Simultaneous display allows you to control the presentation from your computer and at the same time face your audience. You can also connect other output display devices such as LCD projection panels for large-audience presentations.

Power Management

The power management system incorporates an "automatic LCD dim" feature that automatically decides the best settings for your display and at the same time conserves power. See "" on page 24 for more information on power management features.

Dualview

The computer's video chip takes advantage of Windows 98 multi-display capability, allowing you to extend your desktop to an external display device, such as an external monitor or projector. With this feature enabled, you can move program windows to and from the computer LCD and external display device.

Opening and Closing the Display

To open the display, slide the display cover latch to the left and lift up the cover. Then tilt it to a comfortable viewing position. The computer employs a microswitch that turns off the display (and enters Standby mode) to conserve power when you close the display cover, and turns it back on when you open the display cover.

NOTE: If an external monitor is connected, the computer turns off the display (but does not enter standby mode) when you close the display cover.

To close the display cover, fold it down gently until the display cover latch clicks into place.

WARNING: To avoid damaging the display, do not slam it when you close it. Also, do not place any object on top of the computer when the display is closed.

System Block Diagram

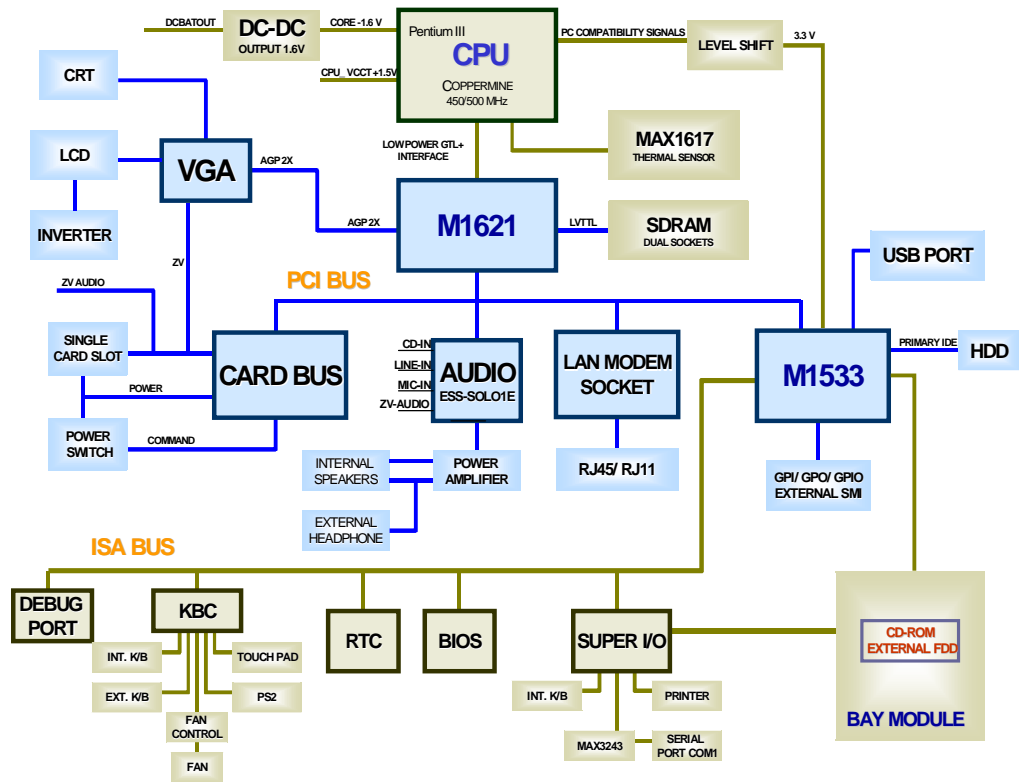

Board Layout

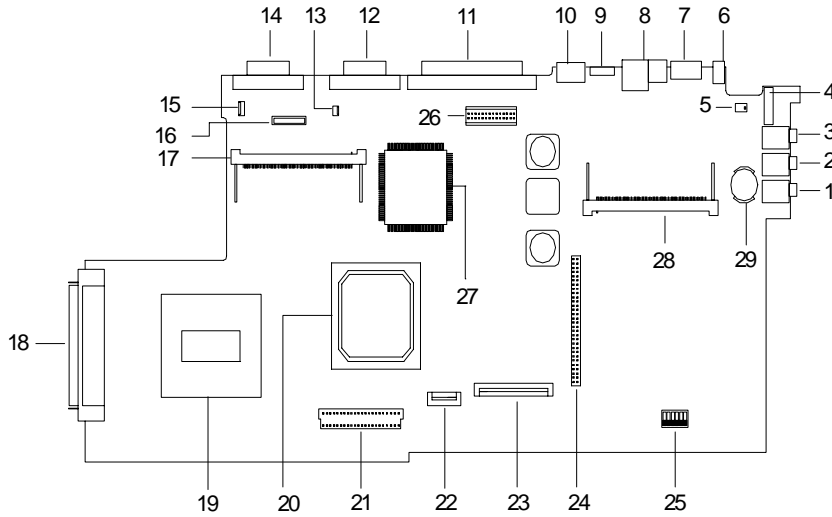

- | | | | |
|----|----------------------------|----|---|
| 1 | Microphone-in Port | 16 | LCD Connector |
| 2 | Line-in port | 17 | DIMM Socket 1 |
| 3 | Line-out port | 18 | External FDD, CD/DVD-ROM Module Connector |
| 4 | Power Switch | 19 | CPU |
| 5 | LCD Cover Switch Connector | 20 | North Bridge ALI M1621 |
| 6 | AC Adapter Connector | 21 | HDD Board Connector |
| 7 | USB Port | 22 | Touchpad Connector |
| 8 | LAN/Modem Connector | 23 | Internal Keyboard Connector |
| 9 | FIR Port | 24 | PCMCIA Socket |
| 10 | PS/2 Port | 25 | Jumper Setting |
| 11 | Parallel Port | 26 | LED/Inverter Board Connector |
| 12 | Serial Port | 27 | VGA Controller Cyber 9525 DVD |
| 13 | Speaker | 28 | Mini PCI Card Connector |
| 14 | Video Port | 29 | RTC Battery |
| 15 | FAN Connector | | |

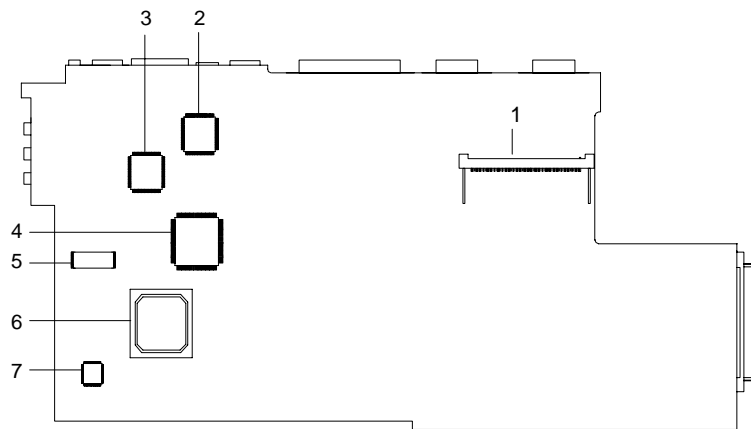

- | | | | |
|---|---------------------------------|---|----------------------------|
| 1 | DIMM Socket 2 | 5 | BIOS Flash ROM |
| 2 | Super I/O Controller NS PC97338 | 6 | South Bridge ALI M1533 |
| 3 | PCI Audio Controller ESS ES1946 | 7 | Keyboard Controller M38867 |
| 4 | PCI CardBus Controller OZ6812 | | |

Panel

Ports allow you to connect peripheral devices to your computer as you would with a desktop PC.

Left Panel

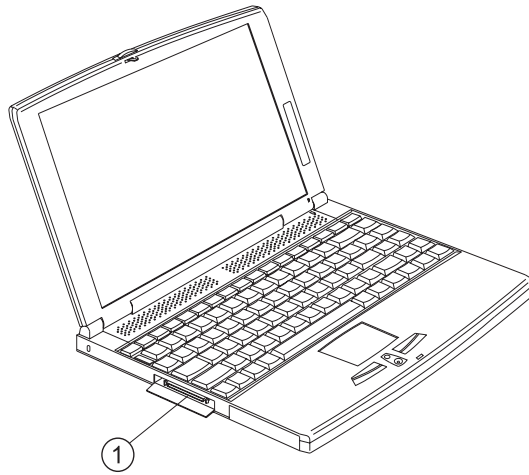





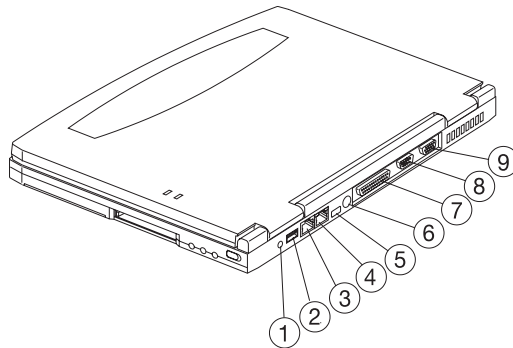

#	Port	Connects to...
1	EasyLink™ Combo Drive connector	EasyLink™ Combo Drive.

Rear Panel



#	Icon	Port	Connects to...
1		Power jack	AC adapter and power outlet
2		USB jack	Universal Serial Bus device (e.g., USB mouse, USB camera)

#	Icon	Port	Connects to...
3		Modem jack	Phone line
4		Network jack	Ethernet 10/100-based network
5		Infrared port	Infrared device (e.g., infrared printer, IR-aware computers)
6		PS/2 port	PS/2-compatible device (e.g., PS/2 keyboard/mouse/keypad)
7		Parallel port	Parallel device (e.g., parallel printer)
8		Serial port	Serial device (e.g., serial mouse)
9		External display port	Display device (e.g., external monitor, LCD projector) up to 1280x1024 resolution at 64K-colors

Universal Serial Bus

The Universal Serial Bus (USB) port is a high-speed serial bus which allows you to connect and daisy-chain USB peripherals without taking up precious system resources.

Fax/data modem

Some models have a built-in V.90 56Kbps PCI fax/data modem.

WARNING: This modem port is not compatible with digital phone lines. Plugging this modem into a digital phone line will damage the modem.

To use the fax/data modem port, connect a phone cable from the modem port to a telephone jack.

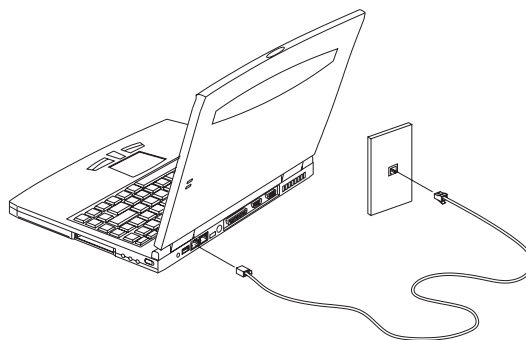

Start your communications software program. See your communications manual for instructions.

Built-in network feature (optional)

Available on selected models, the built-in network feature allows you to connect your computer to an Ethernet-based (10BaseT and 100BaseT) network.

To use the network feature, connect an Ethernet cable from the network jack on the rear of the computer to a network jack or hub on your network. Then configure network settings for your computer.

NOTE: Contact your network or system administrator for information on how to configure your computer to work in your network environment.

Fast infrared

The computer's fast infrared (FIR) port allows you to do wireless data transfer with other IR-aware computers and peripherals such as infrared printers. The infrared port can transfer data at speeds of up to four megabits per second (Mbps) at a distance of up to one meter.

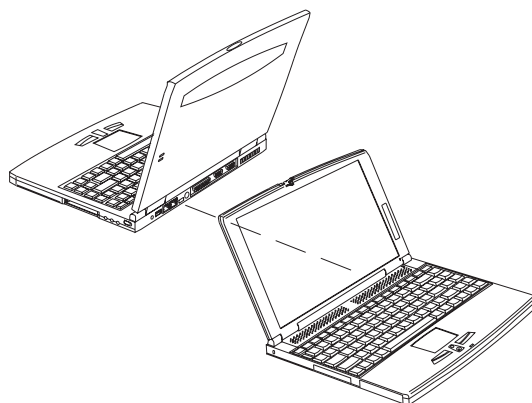

To use FIR, position two IR-aware devices such that their IR ports are no more than one meter apart and offset no more than 15 degrees.



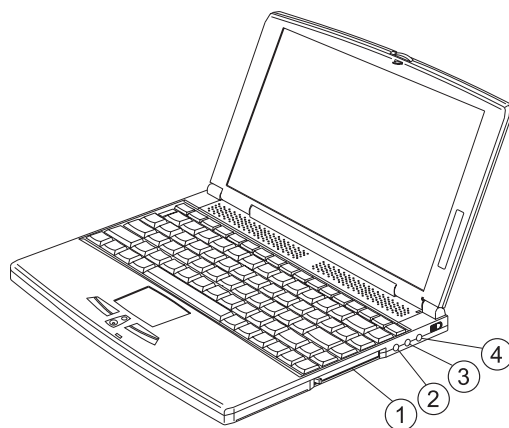

When the two computers are in position, simply begin the data transfer as you normally would. See your file transfer software for details.

Right Panel



#	Icon	Port	Connects to...
1		PC Card slot	One 16-bit PC Card or 32-bit CardBus PC Card (Zoomed Video supported)
2		Microphone-in jack	Mono condenser microphone

#	Icon	Port	Connects to...
3		Line-in jack	Audio line-in device (e.g., audio CD player, stereo walkman)
4		Line-out jack	Audio line-out device (e.g., speakers, headphones)

PC Card slot

There is a type II/III CardBus PC Card slot found on the right panel of the computer. This slot accepts a credit-card-sized card that enhances the usability and expandability of the computer.

PC Cards (formerly PCMCIA) are add-on cards for portable computers, giving you expansion possibilities long afforded by desktop PCs. Popular type II cards include flash memory, SRAM, fax/data modem, LAN and SCSI cards. CardBus improves on the 16-bit PC card technology by expanding the bandwidth to 32 bits.

ZV (Zoomed Video) support allows your computer to support hardware MPEG in the form of a ZV PC card.

NOTE: Refer to your card's manual for details on how to install and use the card and its functions.

Inserting a PC Card

NOTE: A slot protector card is installed in the PC Card slot. Remove it before you insert your PC Card.

Insert the card into the desired slot and make the proper connections (e.g., network cable), if necessary. See your card manual for details.

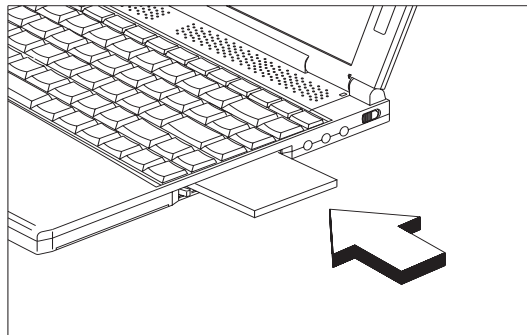

Ejecting a PC Card

Before ejecting a PC Card:

1. Exit the application using the card.
2. Left-click on the PC Card icon on the taskbar and stop the card operation.

3. Press the slot eject button (1) to pop out the eject button (2); then press it again to eject the card (3).

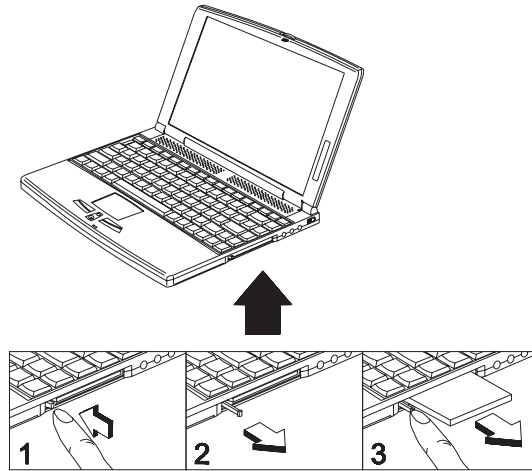





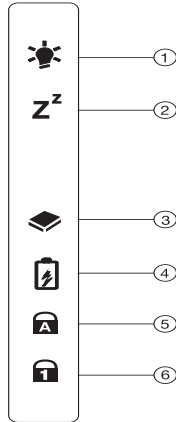

Indicators

The computer has six easy-to-read status icons on the right of the display screen.



The Power and Standby status icons are visible even when you close the display cover so you can see the status of the computer while the cover is closed.

#	Icon	Function	Description
1		Power	Lights when the computer is on.
2		Sleep	Lights when the computer enters Sleep mode.
3		Media Activity	Lights when the floppy drive, hard disk or EasyLink™ Combo Drive is active.
4		Battery Charge	Lights when the battery is being charged.
5		Caps Lock	Lights when Caps Lock is activated.
6		Num Lock	Lights when Num Lock is activated.

Keyboard

The keyboard has full-sized keys and an embedded keypad, separate cursor keys, two Windows keys and twelve function keys.



Hot Keys

The computer employs hot keys or key combinations to access most of the computer’s controls like screen contrast and brightness, volume output and the BIOS Utility.

To activate hot keys, press and hold the **Fn** key before pressing the other key in the hot key combination.



Hot Key	Icon	Function	Description
Fn-F1	?	Hot Key Help	Displays help on hot keys.
Fn-F2		Setup	Accesses the computer’s configuration utility.
Fn-F3		Power Management Scheme Toggle	Switches the power management scheme used by the computer (function available if supported by operating system).
Fn-F4	Zz	Sleep (ACPI) or Standby (APM)	Puts the computer in Sleep mode or Standby mode.
Fn-F5		Display Toggle	Switches display output between the display screen, external monitor (if connected) and both the display screen and external monitor.
Fn-F6		Screen Blank	Turns the display screen backlight off to save power. Press any key to return.
Fn-F7		Touchpad Toggle	Turns the internal touchpad on and off.
Fn-F8		Speaker Toggle	Turns the speakers on and off.
Fn-←		Brightness Down	Decreases the screen brightness.
Fn-→		Brightness Up	Increases the screen brightness.
Fn-↑		Volume Up	Increases the volume.

Hot Key	Icon	Function	Description
Fn-↓		Volume Down	Decreases the volume.
Alt Gr-Euro		Euro	Types the euro symbol.

The euro symbol

If your keyboard layout is set to United States-International or United Kingdom or if you have a keyboard with a European layout, you can type the Euro symbol on your keyboard.

NOTE: For US keyboard users: The keyboard layout is set when you first set up Windows. For the Euro symbol to work, the keyboard layout has to be set to United States-International.

To verify the keyboard type:

1. Click on **Start, Settings, Control Panel**.
2. Double-click on **Keyboard**.
3. Click on the **Language** tab.
4. Verify that the keyboard layout used for "English (United States)" is set to United States-International.

If not, select and click on **Properties**; then select **United States-International** and click on **OK**.

5. Click on **OK**.

To type the Euro symbol:

1. Locate the Euro symbol on your keyboard.
2. Open a text editor or word processor.
3. Hold **Alt Gr** and press the Euro symbol.

NOTE: Some fonts and software do not support the Euro symbol. Please refer to <http://www.microsoft.com/typography/faq/faq12.htm> for more information.

Hardware Configuration and Specification

System Board Major Chips

Item	Controller
System core logic	ALI M1621/M1533
Super I/O controller	NS PC97338VJG
Audio controller	KB 9525
Hard disk drive controller	M5229
Keyboard controller	M38867
RTC	BQ3285LD

Processor

Item	Specification
CPU type	Intel Pentium III 450/500 MHz processor with 256KB L2 on-die Cache
CPU package	BGA package
CPU core voltage	1.60V
CPU I/O voltage	1.50V

BIOS

Item	Specification
BIOS vendor	Acer
BIOS Version	V 3.0
BIOS ROM type	Flash ROM
BIOS ROM size	256KB
BIOS package	32-pin PLCC
Supported protocols	ACPI 1.0a, APM 1.2, PC Card 95, SM BIOS 2.1, EPP/IEEE 1284, ECP/IEEE 1284 1.7 & 1.9, IrDA, PCI 2.1, PnP 1.0a, PS/2 keyboard and mouse, USB, VESA VGA BIOS, DDC-2B, CD-ROM bootable, Windows keyboard Microsoft Simple Boot Flag
BIOS password control	Set by switch, see SW3 (switch 6) settings

Second Level Cache

Item	Specification
Cache controller	Build in ALI 1621
Cache size	256 KB
1st level cache control	Always enabled
2st level cache control	Always enabled
Cache scheme control	Fixed in write-back

System Memory

Item	Specification
Memory controller	ALI M1621
Onboard memory size	0MB
DIMM socket number	2 sockets (2 banks)
Supports memory size per socket	32/64/128 MB
Supports maximum memory size	256MB (128MB x 2)
Supports DIMM type	Synchronous DRAM

System Memory

Item	Specification
Supports DIMM Speed	100MHz
Supports DIMM voltage	3.3V
Supports DIMM package	144-pin DIMM
Memory module combinations	You can install memory modules in any combinations as long as they match the above specifications.

Memory Combinations

Slot 1	Slot 2	Total Memory
32MB	0	32MB
0	32MB	32MB
64MB	0	64MB
0	64MB	64MB
32MB	32MB	64MB
64MB	32MB	96MB
32MB	64MB	96MB
128MB	0	128MB
0	128MB	128MB
64MB	64MB	128MB
128MB	32MB	160MB
32MB	128MB	160MB
128MB	64MB	192MB
64MB	128MB	192MB
128MB	128MB	256MB

Above table lists some system memory configurations. You may combine DIMMs with various capacities to form other combinations.

NOTE: The shipping specification for DIMM combination is 64MB in slot 1.

LAN/Modem Combo Interface

Item	Specification
Chipset	Ambit T60.082.C.00
Fax modem data baud rate (bps)	14.4K
Data modem data baud rate (bps)	56K
Supports modem protocol	V.90 data modem 56K, V.90 fax modem 14.4K and digital line protection operation
Supports LAN protocol	10/100 Mbps
Modem/LAN connector type	RJ11/RJ45
Modem/LAN connector location	Rear side

Modem Interface

Item	Specification
Chipset	Ambit J07.M039.00
Fax modem data baud rate (bps)	14.4K
Data modem data baud rate (bps)	56K

Modem Interface

Item	Specification
Supports modem protocol	V.90 data modem 56K, V.90 fax modem 14.4K and digital line protection operation
Modem connector type	RJ11
Modem connector location	Rear side

Hard Disk Drive Interface

Item	Specification	
Vendor & Model Name	IBM DARA-206000	IBM DARA-209000
Drive Format		
Capacity (MB)	6000	9000
Bytes per sector	512	512
Logical heads	15	16
Logical sectors	63	63
Drive Format		
Logical cylinders	12416	16383
Physical read/write heads	2	3
Disks	1	2
Spindle speed (RPM)	4200	4200
Performance Specifications		
Buffer size	418	418
Interface	IDE(ATA-4)	IDE(ATA-4)
Data transfer rate (disk-buffer, Mbytes/s)	10.69~20.2	10.69~20.2
Data transfer, rate (host~buffer, Mbytes/s)	16.6 (PIO mode 4) 66.6 (Ultra DMA mode 4)	
DC Power Requirements		
Voltage tolerance	5+5%	5+5%

CD-ROM/Floppy Diskette Combo Drive Interface

Item	Specification
Vendor & model name	TEAC CF240500
CD-ROM	
Performance Specification	
Transfer rate (KB/sec)	1,545KB/sec ~ 3,600KB/sec. (FULL - CAV)
Access time (typ.)	130 ms
Rotation speed	5136 rpm (typ.)
Buffer memory	128 KB
Interface	ATAPI
Applicable disc format	CD-DA, CD-ROM (Mode-1, Mode-2), CD-ROM XA MODE-2 (FORM-1, FORM-2), Multi-Session Photo CD, CD-I, Video CD, Enhanced CD & CD PLUS Compatible, CD-R/W
Loading mechanism	Drawer with soft eject and emergency eject hole
Power Requirement	
Input Voltage	5 V
Diskette Drive	

CD-ROM/Floppy Diskette Combo Drive Interface

Item	Specification		
Floppy Disk Specifications			
Media recognition	2DD (720KB)	2HD (1.2MB, 3-mode)	2HD (1.44MB)
Sectors / track	9	15	18
Tracks	80	80	80
Data transfer rate (Kbit/s)	250	500	500
Rotational speed (RPM)	300	360	300
Read/write heads	2		
Encoding method	MFM		
Power Requirement			
Input Voltage (V)	+5V +-10%		

DVD-ROM/Floppy Diskette Combo Drive Interface

Item	Specification		
Vendor & model name	TEAC DF220500		
DVD-ROM			
Performance Specification	With CD Diskette		With DVD Diskette
Transfer rate (KB/sec)	1,290KB/sec ~ 3,000KB/sec. (FULL - CAV)		2,769 KB/sec. (FULL - CAV)
Access time (typ.)	130 ms		170 ms
Rotation speed	4280 rpm (typ.)		1148~2776 rpm (typ.)
Buffer memory	512 KB		512 KB
Interface	ATAPI		
Applicable disc format	DVD-ROM, DVD-Video, CD-DA, CD-ROM (Mode-1, Mode-2), CD-ROM XA MODE-2 (FORM-1, FORM-2), Multi-Session Photo CD, CD-I, Video CD, Enhanced CD & CD PLUS Compatible, CD-R/W		
Loading mechanism	Drawer with soft eject and emergency eject hole		
Power Requirement			
Input Voltage	5 V		
Diskette Drive			
Floppy Disk Specifications			
Media recognition	2DD (720KB)	2HD (1.2MB, 3-mode)	2HD (1.44MB)
Sectors / track	9	15	18
Tracks	80	80	80
Data transfer rate (Kbit/s)	250	500	500
Rotational speed (RPM)	300	360	300
Read/write heads	2		
Encoding method	MFM		
Power Requirement			
Input Voltage (V)	+5V +-10%		

Audio Interface

Item	Specification
Audio Controller	ESS ES1946 Solo-1E
Audio onboard or optional	Built-in
Mono or Stereo	Stereo

Audio Interface

Item	Specification
Resolution	16-bit
Compatibility	SB-Pro, Windows Sound System (WSS), MPU-401, OPL3, OPL3-SA3 Microsoft PC97/PC98/PC99, WHQL audio requirement
Mixed sound source	Voice, Synthesizer, Line-in, Microphone, CD
Voice channel	8/16-bit, mono/stereo
Sampling rate	44.1 KHz
Internal microphone	No
Internal speaker / Quantity	Yes / 1 piece
Supports PnP DMA channel	DMA channel 0 DMA channel 1
Supports PnP IRQ	IRQ3, IRQ5, IRQ7, IRQ9, IRQ10, IRQ11

Video Interface

Item	Specification
Chip vendor	Trident
Chip name	Cyber 9525 DVD
Chip voltage	3.3 Volts
Supports ZV (Zoomed Video) port	Yes
Graph interface	AGP 1X or 2X (Accelerated Graphics Port) bus
Maximum resolution (LCD)	1024x768 (16 bit colors)
Maximum resolution (CRT)	1600x1280 (256 colors)

Video Memory

Item	Specification
Fixed or upgradeable	Fixed, built-in video controller
Video memory size	2.5MB

Video Resolutions Mode

Resolution	Refresh Rate	
	CRT Only	LCD/CRT Simultaneous
640x480x256	85	60
640x480x64K	85	60
640x480x16M	85	60
800x600x256	85	60
800X600X64K	85	60
1024x768x256	60, 75	60

Parallel Port

Item	Specification
Parallel port controller	NS PC97338VJG
Number of parallel port	1
Location	Rear side
Connector type	25-pin D-type connector, in female type
Parallel port function control	Enable/Disable by BIOS Setup

Parallel Port

Item	Specification
Supports ECP/EPP	Yes (set by BIOS setup)
Optional ECP DMA channel (in BIOS Setup)	DMA channel 1 and 3
Optional parallel port I/O address (in BIOS Setup)	3BCh, 378h, 278h
Optional parallel port IRQ (in BIOS Setup)	IRQ5, IRQ7

Serial Port

Item	Specification
Serial port controller	NS PC97338VJG
Number of serial port	1
Supports 16550 UART	Yes
Connector type	9-pin D-type connector, in male type
Location	Rear side
Serial port function control	Enable/Disable by BIOS Setup
Optional serial port (in BIOS Setup)	3F8h, 3E8h, 2E8h
Optional serial port IRQ (in BIOS Setup)	IRQ4, IRQ11

USB Port

Item	Specification
OHCI	USB 1.0
Number of USB port	1
Location	Rear side
Serial port function control	Enable/Disable by BIOS Setup

IrDA Port

Item	Specification
IrDA FIR port controller	NS PC97338VJG
Number of IrDA FIR port	1
Location	Rear side
IrDA FIR port function control	Enable/disable by BIOS Setup
Optional IrDA FIR port (in BIOS Setup)	2F8h, 3F8h, 3E8h, 2E8h
Optional IrDA FIR port IRQ (in BIOS Setup)	IRQ3, IRQ4, IRQ10, IRQ11
Optional IrDA FIR port DRQ (in BIOS Setup)	DRQ3, DRQ1, DRQ0

PCMCIA Port

Item	Specification
PCMCIA controller	O2 OZ6812
Supports card type	Type-II/I
Number of slots	One type-II/I
Access location	Right side
Supports ZV (Zoomed Video) port	Yes
Supports 32 bit CardBus	Yes (IRQ9)

Keyboard

Item	Specification
Keyboard controller	Mitsubishi M38867
Keyboard vendor & model name	JME K9811
Total number of keypads	85/89-key
Windows 95 keys	Yes
Internal & external keyboard work simultaneously	Yes

Battery

Item	Specification
Vendor & model name	Panasonic CGP-E/618AE
Battery Type	Li-ion
Pack capacity	2800 mAh
Cell voltage	3.6V/cell
Number of battery cell	6
Package configuration	3 cells in series, 2 series in parallel
Package voltage	10.8 V

DC-AC LCD Inverter

Item	Specification				
Vendor & model name	Ambit T62.123.C.01 Sumida IV12149				
Input voltage (V)	7.3 (min.)	-	-	-	21 (max.)
Input current (mA)	-	-	-	-	900 (max.)
Output voltage (Vrms, no load)	-	-	565 (typ.)	-	-
Output voltage frequency (kHz)	40 (min.)	-	-	-	65 (max.)
Output Current/ Lamp	Iout(Min)	0.7mA	1.0mA	1.3mA	Vadj=0V
	Iout(Max)	5.4mA	6.0mA	6.6mA	Vadj=3.2V

NOTE: DC-AC inverter is used to generate very high AC voltage, then support to LCD CCFT backlight user, and is also responsible for the control of LCD brightness. Avoid touching the DC-AC inverter area while the system unit is turned on.

NOTE: There is an EEPROM in the inverter, which stores its supported LCD type and ID code. If you replace a new inverter or replace the LCD with a different brand, use Inverter ID utility to update the ID information.

LCD

Item	Specification
Vendor & model name	Torisan TM121SV-02L04
Mechanical Specifications	
LCD display area (diagonal, inch)	12.1
Display technology	TFT
Resolution	SVGA (800x600)

LCD

Item	Specification
Supports colors	262,144 colors
Optical Specification	
Brightness control	keyboard hotkey
Contrast control	keyboard hotkey
Electrical Specification	
Supply voltage for LCD display (V)	3.3 (typ.)
Supply voltage for LCD backlight (Vrms)	630(typ.)

AC Adapter

Item	Specification
Vendor & model name	Delta ADT-60XB D 3P
Input Requirements	
Maximum input current (A, @90Vac, full load)	1.5 A @ 90Vac 0.9 A @ 180Vac
Nominal frequency (Hz)	47 - 63
Frequency variation range (Hz)	47 - 63
Nominal voltages (Vrms)	90 - 270
Inrush current	The maximum inrush current will be less than 50A and 100A when the adapter is connected to 115Vac(60Hz) and 230Vac(50Hz) respectively.
Efficiency	It should provide an efficiency of 83% minimum, when measured at maximum load under 115V(60Hz).
Output Ratings (CV mode)	
DC output voltage	+19.0V~20.0V
Noise + Ripple	300mvp-pmax (20MHz bandwidth)
Load	0 A (min.) 2.4 A (max.)
Output Ratings (CC mode)	
DC output voltage	+12V ~ +19V
Constant output	2.75 ± 0.2 A
Dynamic Output Characteristics	
Turn-on delay time	2 sec. (@115Vac)
Hold up time	4 ms min. (@115 Vac input, full load)
Over Voltage Protection (OVP)	24 V
Short circuit protection	Output can be shorted without damage
Electrostatic discharge (ESD)	15kV (at air discharge) 8kV (at contact discharge)
Dielectric Withstand Voltage	
Primary to secondary	1500 Vac (or 2121 Vdc), 10 mA for 1 second
Leakage current	0.25 mA max. (@ 254 Vac, 60Hz)
Regulatory Requirements	Internal filter meets: 1. FCC class B requirements. (USA) 2. VDE 243/1991 class B requirements. (German) 3. CISPR 22 Class B requirements. (Scandinavia) 4. VCCI class II requirements. (Japan)

Power Management

Power Saving Mode	Phenomenon
<p>Standby Mode Waiting time specified by the System Standby value or the operating system elapses without any system activity. Or When the computer is about to enter Hibernation mode (e.g., during a battery-low condition), but the Hibernation file is invalid or not present.</p>	<input type="checkbox"/> The buzzer beeps <input type="checkbox"/> The Sleep indicator lights up
<p>Hibernation Mode When customized functions for power management are set to Hibernation and the corresponding action is taken.</p>	<input type="checkbox"/> All power shuts off
<p>Display Standby Mode Keyboard, built-in touchpad, and an external PS/2 pointing device are idle for a specified period.</p>	<input type="checkbox"/> The display shuts off
<p>Hard Disk Standby Mode Hard disk is idle within a specified period of time.</p>	<input type="checkbox"/> Hard disk drive is in standby mode. (spindle turned-off)

Environmental Requirements

Item	Specification
Temperature	
Operating	+5 ~ +35 Degree C
Non-Operating	-20 ~ + 60 Degree C
Humidity	
Operating	20% ~ 80% RH, Non-condensing
Non-Operating	20% ~ 90% RH, Non-condensing
Vibration	
Operating (Unpacked)	5 ~ 25.6 Hz, 0.38 mm (peak to peak)
	25.6 ~ 250Hz, 0.5G
Non-Operating	
Unpacked	5 ~ 27.1 Hz, 0.6G
	27.1 ~ 50 Hz, 0.4 mm (peak to peak)
	50 ~ 500 Hz, 2.0G
Packed	5 ~ 62.6 Hz, 0.51 mm (peak to peak)
	62.6 ~ 500 Hz, 4 G

Mechanical Specification

Item	Specification
Dimensions	289 mm (W) x 219 mm (D) x 23.5 mm (H)
Weight	41 lb (including battery)
I/O Ports	1 P/S2 Port, 1 Parallel Port, 1 Serial Port, 1 USB, 1 Modem Port, 1 LAN Port, 1 PCMCIA Slot, 1 VGA Port, 1 Microphone Port, 1 Line-in Port, 1 Line-out Port, 1 EasyLink™ Port, 1 DC-IN Port for AC adapter
Drive Bays	None

Mechanical Specification

Item	Specification
Material	Housing: MG-AL Panel : Plastic
Indications	Power LED, Sleep LED, Media Activity, Battery Charge, Caps Lock
Switch	Power

Memory Address Map

Memory Address	Size	Function
00000000-0009FFFF	640 KB	Base memory
000A0000-000BFFFF	128 KB	Video memory
000C0000-000C9FFF	40 KB	Video BIOS
000CA000-000CBFFF	8 KB	I/O ROM
000E0000-000FFFFF	128 KB	System BIOS
00100000-top limited	--	Extended (DIMM) memory
04301000-04301FFF	4 KB	PCMCIA controller (slot 1)
04302000-04302FFF	4 KB	PCMCIA controller (slot 2)
04300000-04300FFFF	64 KB	USB controller
FFFF0000-FFFFFFFF	64 KB	System board extension for PnP BIOS

I/O Address Map

I/O Address	Function
000-00F	DMA controller-1
020-021	Interrupt controller-1
040-043	Timer 1
060, 064	Keyboard controller 8742 chip select
061	System speaker out
040B	DMA controller-1
061	System speaker
070-071	Real-time clock and NMI mask
080-08F	DMA page register
0A0-0A1	Interrupt controller-2
0C0-0DF	DMA controller-2
0F0-0FF	Numeric data processor
120-13F 180-18F	Power management controller
170-177	2nd EIDE device (CD-ROM) select
1F0-1F7	1st EIDE device (hard drive) select
220-22F	Audio
240-24F	Audio (optional)
278-27F	Parallel port 3
2E8-2EF	COM4
2F8-2FF	COM2 or FIR (optional)
378, 37A	Parallel port 2
3BC-3BE	Parallel port 1
3B0-3BB 3C0-3DF	Video Controller

I/O Address Map

I/O Address	Function
3F0h-3F7	Standard Floppy Disk Controller
3E8-3EF	COM3 or LT Win modem (optional)
3F0-3F7	Floppy disk controller
3F8-3FF	COM1
480-48F, 4D6	DMA controller-1
4D0-4D1 CF8-CFF	PCI configuration register

IRQ Assignment Map

Interrupt Channel	Function
NMI	System errors
IRQ0	System timer
IRQ1	Keyboard
IRQ2	Cascade
IRQ3	R2 Card
IRQ4	COM1
IRQ5	Audio or LPT1 (optional)
IRQ6	Floppy
IRQ7	LPT1 or Audio (optional)
IRQ8	Real time clock
IRQ9	Card bus / ACPI / Modem
IRQ10	USB
IRQ11	FIR
IRQ12	PS2 pointing device
IRQ13	Numeric data processor
IRQ14	1st EIDE device (hard disk)
IRQ15	2nd EIDE device (CD-ROM drive)

DMA Channel Assignment

DMA Channel	Function
DRQ0	Audio or FIR (optional)
DRQ1	ECP or Audio or FIR (optional)
DRQ2	Floppy
DRQ3	ECP or FIR (optional)
DRQ4	Not Used
DRQ5	Not used
DRQ6	Not used
DRQ7	Not used

System Utilities

BIOS Setup Utility

The BIOS Setup Utility is a hardware configuration program built into your computer's BIOS (Basic Input/Output System).

Your computer is already properly configured and optimized, and you do not need to run this utility. However, if you encounter configuration problems, you may need to run Setup. Please also refer to Chapter 4 Troubleshooting when a problem arises.

To activate the BIOS Utility, press **F2** during POST (while the TravelMate logo is being displayed).

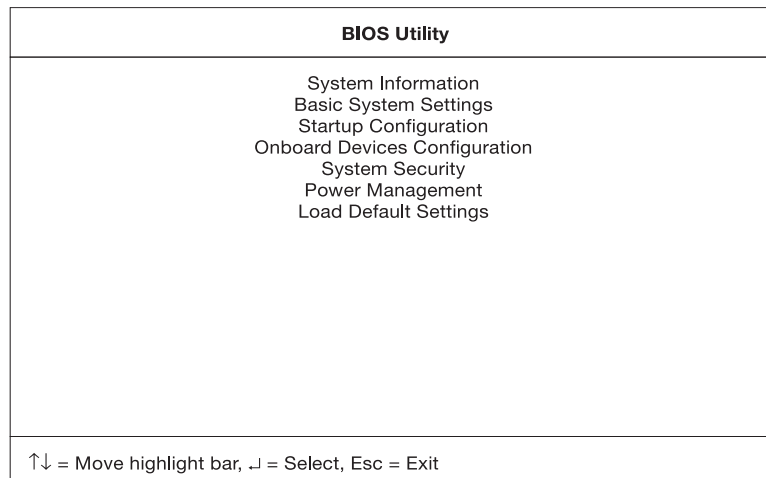

Navigating the BIOS Utility

There are seven menu options: System Information, Basic System Settings, Startup Configuration, Onboard Devices Configuration, System Security, Power Management and Load Default Settings.

Use the cursor **up/down** (↑↓) keys to select a menu item, then press **Enter**.

Within a menu, navigate through the BIOS Utility by following these instructions:

- Press the cursor **up/down** (↑↓) keys to move between parameters.
- Press the cursor **left/right** (→←) keys to change the value of a parameter.
- Press **Esc** while you are in any of the menu options to return to the main menu.

NOTE: You can change the value of a parameter if it is enclosed in square brackets.

NOTE: Navigation keys for a particular menu are shown on the bottom of the screen.

At the main menu, press **Esc** to exit the BIOS Utility. If you make any changes, the following dialog box displays:

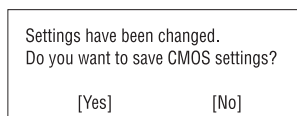

If you would like to keep the changes you made, use the cursor **left/right** (→←) keys to select **Yes**; then press **Enter**. Choose **No** if you want to discard the changes you made.

System Information

The System Information sub-menu displays basic and important information about your computer.

System Information		Page 1/1
CPU Type & Speed -----	Pentium III 450 Mhz	
Floppy Disk Drive -----	None	
Hard Disk Drive -----	5729 MB	
HDD Serial Number -----	AF0AFAL0692	
System with -----	None	
System BIOS Version -----	V3.0 R01-A00.t6	
VGA BIOS Version -----	MTTV15.04	
Serial Number -----	N/A	
Asset Tag Number -----	N/A	
Product Name -----	TravelMate 340 Series	
Manufacturer Name -----	N/A	
UUID -----	00000000000000000000000000000000	
Esc = Exit		

NOTE: The screen above is a sample and may not reflect the actual data on your computer.

The following table describes the information in this sub-menu.

NOTE: “x” may refer to a series of numbers and/or characters or a combination of both.

Parameter	Description	Format
CPU Type & Speed	Shows the type and speed in Megahertz (MHz) of the Central Processing Unit (CPU)	
Floppy Disk Drive	Shows the floppy disk drive type	
Hard Disk Drive	Shows the size or capacity of the hard disk	
HDD Serial Number	Shows the serial number of the hard disk	
System with	Shows the EasyLink Combo Drive type, CD-ROM or DVD-ROM.	
System BIOS Version	Shows the version number of the BIOS.	Vx Rx (version and release numbers)
VGA BIOS Version	Shows the version number of the VGA display BIOS.	Vx Rx (version and release numbers)
Serial Number	Shows the serial number of the system. It is the number identical to the system serial number labelled at the bottom of the system unit. The default serial number is scanned while manufacturing, and stored to the LCD inverter.	
Asset Tag Number	Shows the asset tag number of the computer. The default setting is empty. Customers can input it from the Notebook Manager. It will be stored in LCD inverter.	
Product Name	Shows the official name of the product “brand name + model name”. The default setting of TravelMate 340. Product name will be stored in LCD inverter.	
Manufacturer Name	Shows the name of the manufacturer and stored in LCD inverter. The default setting is Acer.	

Parameter	Description	Format
UUID	Shows the universally unique identifier number of the computer, also known as GUID (Globally Unique Identifier). It is the requirement specification of SMBIOS 2.1 (System Management BIOS). UUID are fixed-size 128-bit value and are unique across both space and time as well as stored in LCD inverter. UUID number can identify a person and even confidential documents user created.	

The items in this sub-menu are important and vital information about your computer. If you experience computer problems and need to contact technical support, this data helps our service personnel know more about your computer.

Basic System Settings

The Basic System Settings sub-menu allows you to set the system date and time.

Basic System Settings		Page 1/1
Date -----	[Fri Aug 27, 1999]	
Time -----	[10:06:35]	
↑↓ = Move highlight bar, ←→ = Change setting, F1 = Help		

The following table describes the parameters in this sub-menu.

Parameter	Description	Format
Date	Sets the system date.	DDD MMM DD, YYYY (day-of-the-week month day, year)
Time	Sets the system time.	HH:MM:SS (hour:minute:second)

Startup Configuration

The Startup Configuration sub-menu contains parameter values that define how your computer behaves on system startup.

Startup Configuration		Page 1/1
Boot Display -----	[Auto]	
Screen Expansion -----	[Enabled]	
USB Function Support -----	[Enabled]	
Hotkey Beep -----	[Enabled]	
Fast Boot -----	[Enabled]	
Boot Drive Sequence:		
1st. -----	[Floppy Disk]	
2nd. -----	[Hard Disk]	
3rd. -----	[CD-ROM]	
↑↓ = Move highlight bar, ←→ = Change setting, F1 = Help		

The following table describes the parameters in this sub-menu. Settings in **boldface** are the default and suggested parameter settings.

Parameter	Description	Options
Boot Display	Sets the display on boot-up. When set to Auto , the computer automatically determines the display device when the computer starts up. If an external display device (e.g., monitor) is connected, it becomes the boot display; otherwise, the computer LCD is the boot display. When set to Both , the computer outputs to both the computer LCD and an external display device if one is connected.	Auto or Both
Screen Expansion	Enables or disables the screen expansion feature. When enabled, DOS screens expand to fill the LCD.	Disabled or Enabled
USB Function Support	Enables or disables the Universal Serial Bus (USB) port.	Disabled or Enabled
Hotkey Beep	Enables or disables a system beep when a hotkey or key combination is pressed.	Enabled or Disabled
Fast Boot	Fast Boot allows your computer to boot up and resume from Sleep mode (including Standby and Hibernation modes) faster. When enabled, the operating system and BIOS communicate information about Plug-and-Play resources and previous boot-ups.	Enabled or Disabled
Boot Drive Sequence	Specifies the order in which the computer starts up from. See the section below.	1st: Floppy Disk, 2nd: Hard Disk, 3rd: CD-ROM

Setting the Boot Drive Sequence

The Boot Drive Sequence section lists boot priorities (1st, 2nd and 3rd) for bootable drives in your computer.

For example, the default value (1st:Floppy Disk, 2nd:Hard Disk, and 3rd:CD-ROM) tells the computer to first search for a bootable floppy disk in the floppy drive. If it finds one present, it boots up from that floppy disk. If not, the computer continues by booting up from the hard disk. If it cannot boot up from the hard disk, it continues to search for a bootable CD-ROM in the CD-ROM drive.

To set the boot drive sequence, use the cursor **up/down** (↑↓) keys to select a priority level (1st, 2nd, or 3rd); then use the cursor **left/right** (←→) keys to select the device for that priority level.

Onboard Devices Configuration

The parameters in this screen are for advanced users only. You do not need to change the values in this screen because these values are already optimized.

The Onboard Devices Configuration sub-menu assigns resources to basic computer communication hardware.

Onboard Devices Configuration		Page 1/1
Serial Port -----	[Enabled]	
Base Address -----	[3F8h]	
IRQ -----	[4]	
IrDA FIR -----	[Enabled]	
Base Address -----	[2F8h]	
IRQ -----	[11]	
DMA -----	[3]	
Parallel Port -----	[Enabled]	
Base Address -----	[378h]	
IRQ -----	[7]	
Operation Mode -----	[ECP]	
ECP DMA Channel -----	[1]	
↑↓ = Move highlight bar, ←→ = Change setting, F1 = Help		

The following table describes the parameters in this sub-menu. Settings in **boldface** are the default and suggested parameter settings.

Parameter	Description	Options
Serial Port	Enables or disabled the serial port. When enabled, you can set the base I/O address and interrupt request (IRQ) of the serial port.	Enabled or Disabled 3F8h , 3E8h, 2F8h or 2E8h 4 or 11
IrDA Port	Enables or disables the infrared port. When enabled, you can set the base I/O address, interrupt request (IRQ) and direct memory access (DMA) channel of the infrared port.	Enabled or Disabled 2F8h , 3E8h, 3F8h, or 2E8h 3 or 10
Parallel Port	Enables or disables the parallel port. When enabled, you can set the base I/O address, interrupt request (IRQ) and operation mode of the parallel port. If operation mode is set to ECP, the direct memory access (DMA) channel of the parallel port is set to 1.	Enabled or Disabled 378h , 278h, or 3BCh 7 or 5 ECP , EPP, Standard, or Bi-directional

System Security

The System Security sub-menu allows you to safeguard your computer and data with passwords and other security measures.

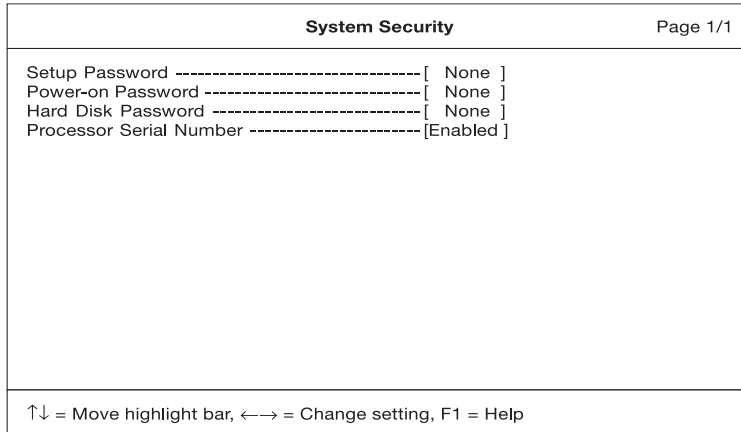

The following table describes the parameters in this screen. Settings in **boldface** are the default and suggested parameter settings.

Parameter	Description	Options
Setup Password	When set, this password protects the computer and this BIOS Utility from unauthorized entry. See the following section for instructions on how to set a password.	Disabled or Enabled
Power-on Password	When set, this password protects the computer from unauthorized entry. See the following section for instructions on how to set a password.	Disabled or Enabled
Hard Disk Password	When set, this password protects the hard disk from unauthorized access. See the following section for instructions on how to set a password.	Disabled or Enabled
Processor Serial Number	The Pentium III processor includes a unique serial number which allows individual CPUs to be identified. You can turn off this feature by setting this parameter to Disabled.	Enabled or Disabled

Setting a Password

Follow these steps:

- Use the cursor up/down keys to highlight a Password parameter (Setup, Power-on or Hard Disk) and press the **Enter** key. The password box appears:
- Type a password. The password may consist of up to seven characters (A-Z, a-z, 0-9).

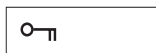

IMPORTANT: Be very careful when typing your password because the characters do not appear on the screen.

- Press **Enter**. Retype the password to verify your first entry and press **Enter**.

After setting the password, the computer automatically sets the chosen password parameter to Present.

Three password types protect your computer from unauthorized access. Setting these passwords creates several different levels of protection for your computer and data:

- ❑ Setup Password prevents unauthorized entry to the BIOS Utility. Once set, you must key-in this password to gain access to the BIOS Utility.
- ❑ Power-On Password secures your computer against unauthorized use. Combine the use of this password with password checkpoints on boot-up and resume from hibernation for maximum security.
- ❑ Hard Disk Password protects your data by preventing unauthorized access to your hard disk. Even if the hard disk is removed from the computer and moved to another computer, it cannot be accessed without the Hard Disk Password.

When a password is set, a password prompt appears on the left-hand corner of the display screen.

1. When the Setup Password is set, the following prompt appears when you press **F2** to enter the BIOS Utility at boot-up.

Setup Password

Type the Setup Password and press **Enter** to access the BIOS Utility.

2. When the Power-on Password is set, the following prompt appears at boot-up.



Type the Power-on Password (a symbol appears for each character you type) and press **Enter** to use the computer. If you enter the password incorrectly, an **x** symbol appears. Try again and press **Enter**.

3. When the Hard Disk Password is set, the following prompt appears at boot-up.



Type the Hard Disk Password (a symbol appears for each character you type) and press **Enter** to use the computer. If you enter the password incorrectly, an **x** symbol appears. Try again and press **Enter**.

IMPORTANT: You have three chances to enter a password. If you successfully entered the password, the following symbol appears.



If you fail to enter the password correctly after three tries, the following message or symbol appears.

Setup
 Incorrect password specified. System disabled.

Power-on/Hard Disk



Setting passwords

Removing a Password

Should you decide to remove a password, do the following:

- ❑ Use the cursor **up/down** (↑↓) keys to highlight a Password parameter (Setup, Power-on or Hard Disk).
- ❑ Use the cursor **left/right** (→←) key to remove the password.

NOTE: When you want to remove the Hard Disk password, you are prompted for the Hard Disk password before it is removed.

NOTE: The jumper setting **switch 6 of SW3** on the system main board, the default setting is “**OFF: check password**”, this means that the system will always check the password that the user set in. However, if users miss their own password, the servicers can switch the jumper to “**ON: Bypass password**” and then the Setup password and Power-on password will be unlock. Therefore, users can reset their new

password. (Refer to Chapter 5 Jumper and Connector Information for more information on setting the switches.)

IMPORTANT: If Setup password is forgot by users, service technician may need to update computer's BIOS or set up jumper SW3 switch 6 on mainboard to bypass.

IMPORTANT: If Power-on password is forgot by users, service technician may set the jumper SW3 to bypass password to remove the password.

IMPORTANT: If Hard Disk Password is missing, service technician can solve the lock of hard disk by using master HDD password utility. For the HDD password utility, service technician can contact with local service management level.

Changing a Password

To change a password, follow these steps:

- Remove the current password. See "Removing a Password" on page 31.
- Set a new password. See "Three password types protect your computer from unauthorized access. Setting these passwords creates several different levels of protection for your computer and data:" on page 30.

Power Management

The Power Management screen contains parameters that are related to power-saving and power management.

Power Management		Page 1/1
System Resume Timer -----	[Disabled]	
System Resume Date -----	[----:--]	
System Resume Time -----	[--:--]	
Battery-low Warning Beep -----	[Enabled]	
Sleep Upon Battery-low -----	[Enabled]	
↑↓ = Move highlight bar, ←→ = Change setting, F1 = Help		

The following table describes the parameters in this screen. Settings in **boldface** are the default and suggested parameter settings.

NOTE: If your system has ACPI, all power management functions are taken care of by Windows.

Parameter	Description	Options or Format
System Resume Timer	When enabled and the system resume date and time are valid, the computer resumes (wakes up) at the set time and date.	Disabled or Enabled MMM DD,YYYY (day/month/year) HH:MM:SS (hour:minute:second)
Battery-low Warning Beep	Enables or disables warning beeps during a battery-low condition.	Enabled or Disabled
Sleep Upon Battery-low	Enables or disables the Hibernation function during a battery-low condition When the computer is very low on battery power, the computer will enter Hibernation mode if Sleep Manager is installed, active and the Hibernation file is valid.	Enabled or Disabled

Load Default Settings

If you want to restore all parameter settings to their default values, select this menu item and press **Enter**. The following dialog box displays.

Do you want to load default settings?

[Yes] [No]

If you would like to load default settings for all parameters, use the cursor **left/right** (→←) keys to select **Yes**; then press **Enter**. Choose **No** if otherwise.

Flash Utility

The BIOS flash memory update is required for the following conditions:

- New versions of system programs
- New features or options

Use the AFlash utility to update the system BIOS flash ROM.

NOTE: Do not install memory-related drivers (XMS, EMS, DPMI) when you use AFlash.

NOTE: This program contains a readme.txt file. This readme.txt file will introduce how to use AFlash utility.

Executing Flash Program

IMPORTANT: If this diskette is not bootable, do the following actions before you use it:

1. Create a bootable disk.
2. Copy all AFlash files into this bootable diskette.
3. Put the bootable disk into TravelMate 340 series mobile, then re-boot.

IMPORTANT: Never turn off the system power while Flash BIOS is programming. This will damage your system.

4. After Flash BIOS is done, reboot the system.

NOTE: If there are any problems occurred during BIOS updated, "Index of PQA Diagnostic Error Code, Message" on page 64 for troubleshooting.

System Utility Diskette

This utility diskette is for the Acer TravelMate 340 notebook machine. It provides the following functions:

1. Panel ID Utility
2. Thermal & Fan Utility
3. Main Board Data Utility

To use this diskette, first boot from this diskette, then a "Microsoft Windows 98 Startup Menu" prompt you to choose the testing item. Follow the instructions on screen to proceed.

NOTE: This program contains a readme.txt file. This readme.txt file will introduce each test utility and its functions.

IMPORTANT: If this diskette is not bootable, do the following actions before you use it:

1. Do system transfers.
2. Copy HIMEM.SYS to A:\.
3. Copy EMM386.EXE to A:\.

Panel ID Utility

There is an EEPROM in the inverter which stores its supported LCD type ID code. If you replace an LCD with one of a different brand or use a new inverter, the ID information in the inverter EEPROM should be updated.

Follow the steps below to see the LCD Panel ID:

1. Follow the instruction on screen to read current or to set new LCD Panel ID code.

NOTE: When you set a new LCD Panel ID and the new LCD is not yet enabled (to function), so connect an external CRT to see the program execution process.

NOTE: Make sure the new ID code you choose corresponds with the LCD brand and type. If you write a wrong ID into inverter, just reboot and re-execute the program and input the correct ID code.

2. Restart computer - the new LCD should work normally.

NOTE: If LCD cannot display after change ID code, make sure you write the correct ID code, or try reconnecting the LCD FPC cable connectors.

Thermal and Fan Utility

The system is equipped with sensors to protect against system overheating. By setting System and processor thermal thresholds, the system can turn on the cooling fan or shut down automatically when temperatures reach the defined threshold parameters. This utility will test fan, processor thermal and system thermal.

Main Board Data Utility

This utility will display Main Board Data (MBD) which include header information, product name, manufacture name, UUID (Universally Unique Identifiers) and serial number. This function can display and create MBD data as well as store those information to LCD inverter EEPROM (not flash ROM).

System Diagnostic Diskette

IMPORTANT: ¹The diagnostics program here that we used is called PQA (Product Quality Assurance) and is provided by Acer Headquarters. You can utilize it as a basic diagnostic tool. To get this program, either download it from <http://csd.acer.com.tw> or find it in the TravelMate 340 service CD kit. To better fit local service requirements, your regional office MAY have other diagnostic program. Please contact your regional offices or the responsible personnel/channel to provide you with further technical details.

NOTE: This program contains a readme.txt file. This readme.txt file will introduce each test and its functions.

This diagnostic program divided into two diskettes is for the Acer TravelMate 340 notebook machine. It provides the following functions:

Disk 1:

1. PQA System Diagnostics
2. Audio Resource and Speaker Out Test
3. USB Register and Connect/Disconnect Test

NOTE: The USB setting in BIOS Setup must be set to enable and a USB device is required when executing USB Connection/Disconnection Test, or this test fails.

4. Exit

To use this diskette, first boot from this diskette, then a "Microsoft Windows 98 Startup Menu" prompts you to choose the testing item. Follow the instructions on screen to proceed.

IMPORTANT: If this diskette is not bootable, do the following actions before you use it:

1. Do system transfers.
2. Copy the following files to A:\
HIMEM.SYS
MSCDEX.EXE
LASTDRV.COM
RAMDRIVE.SYS

Disk 2:

1. Infrared Ray Test

NOTE: The Infrared Ray setting in BIOS Setup must be set to enable when executing the Infrared Ray Test.

2. Modem Test

NOTE: A phone line is required for the modem test.

To use this diskette, first boot from this diskette, then a "Microsoft Windows 98 Startup Menu" prompts you to choose the testing item. Follow the instructions on screen to proceed.

IMPORTANT: If this diskette is not bootable, do the following actions before you use it:

1. Do system transfers.
2. Copy the following files to A:\
HIMEM.SYS
EMM386.EXE
CHOICE.COM

NOTE: When executing a parallel or serial port test in System Test item, a loopback tool is needed. This loopback is Acer proprietary design. You may reach the computerhwdoctor@acer.com.tw for ordering information.

¹ New added description. Please pay attention to it.

Running PQA Diagnostics Program

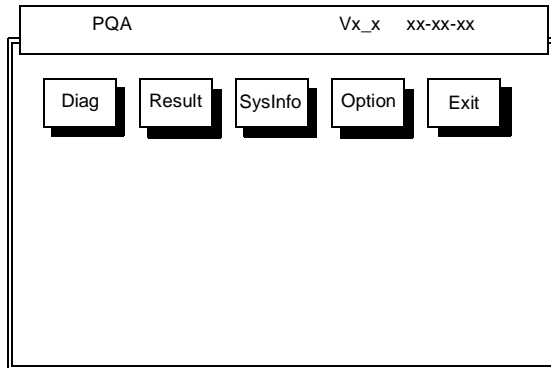

Press →← to move around the main menu. Press Enter to enable the selected option. The main options are Diag, Result, SysInfo, Option and Exit.

The Diag option lets you select testing items and times.

The following screen appears when you select Diag from the main menu.

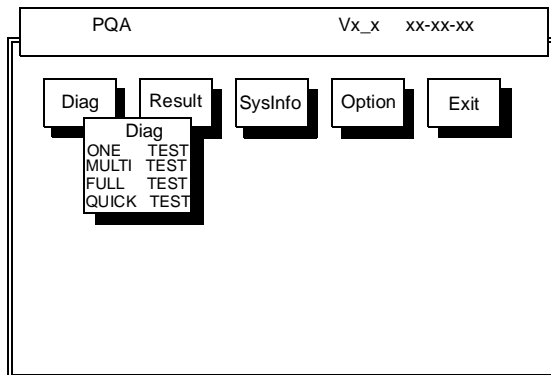

One Test performs a single test and Manual checks the selected test items in sequence.

Multi Test performs multiple tests of the selected items and check the select test items in sequence.

Full Test performs all test items detail for your system.

Quick Test performs all test items quickly for your system.

The screen below appears if you select Multi Test.

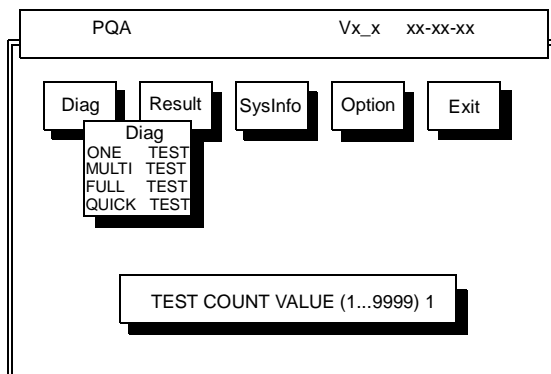

Specify the desired number of tests and press **Enter**.

After you specify the number of tests to perform, the screen shows a list of test items (see below).

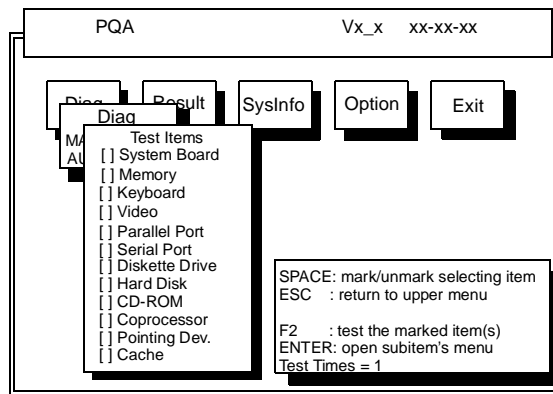

Move the highlight bar from one item to another. Press **Space** to enable or disable the item. Press **Enter** to view the available options of each selected item. Press **Esc** to close the submenu.

The right corner screen information gives you the available function keys and the specified test number.

- Space: Enables/disables the item
- ESC: Exits the program
- F1: Help
- F2: Tests the selected item(s)
- Enter: Opens the available options
- Test Times: Indicates the number of tests to perform.

NOTE: The F1 and F2 keys function only after you finish configuring the Test option.

NOTE: When any errors are detected by diagnostic program, refer to "Index of PQA Diagnostic Error Code, Message" on page 64 for troubleshooting.

Machine Disassembly and Replacement

This chapter contains step-by-step procedures on how to disassemble the notebook computer for maintenance and troubleshooting.

To disassemble the computer, you need the following tools:

- Wrist grounding strap and conductive mat for preventing electrostatic discharge
- Flat-bladed screwdriver
- Phillips screwdriver
- Tweezers
- Flat-bladed screwdriver or plastic stick

NOTE: The screws for the different components vary in size. During the disassembly process, group the screws with the corresponding components to avoid mismatch when putting back the components.

General Information

Before You Begin

Before proceeding with the disassembly procedure, make sure that you do the following:

1. Turn off the power to the system and all peripherals.
2. Unplug the AC adapter and all power and signal cables from the system.
3. Remove the battery pack.

Disassembly Procedure Flowchart

The flowchart on the succeeding page gives you a graphic representation on the entire disassembly sequence and instructs you on the components that need to be removed during servicing. For example, if you want to remove the system board, you must first remove the keyboard, then disassemble the inside assembly frame in that order.

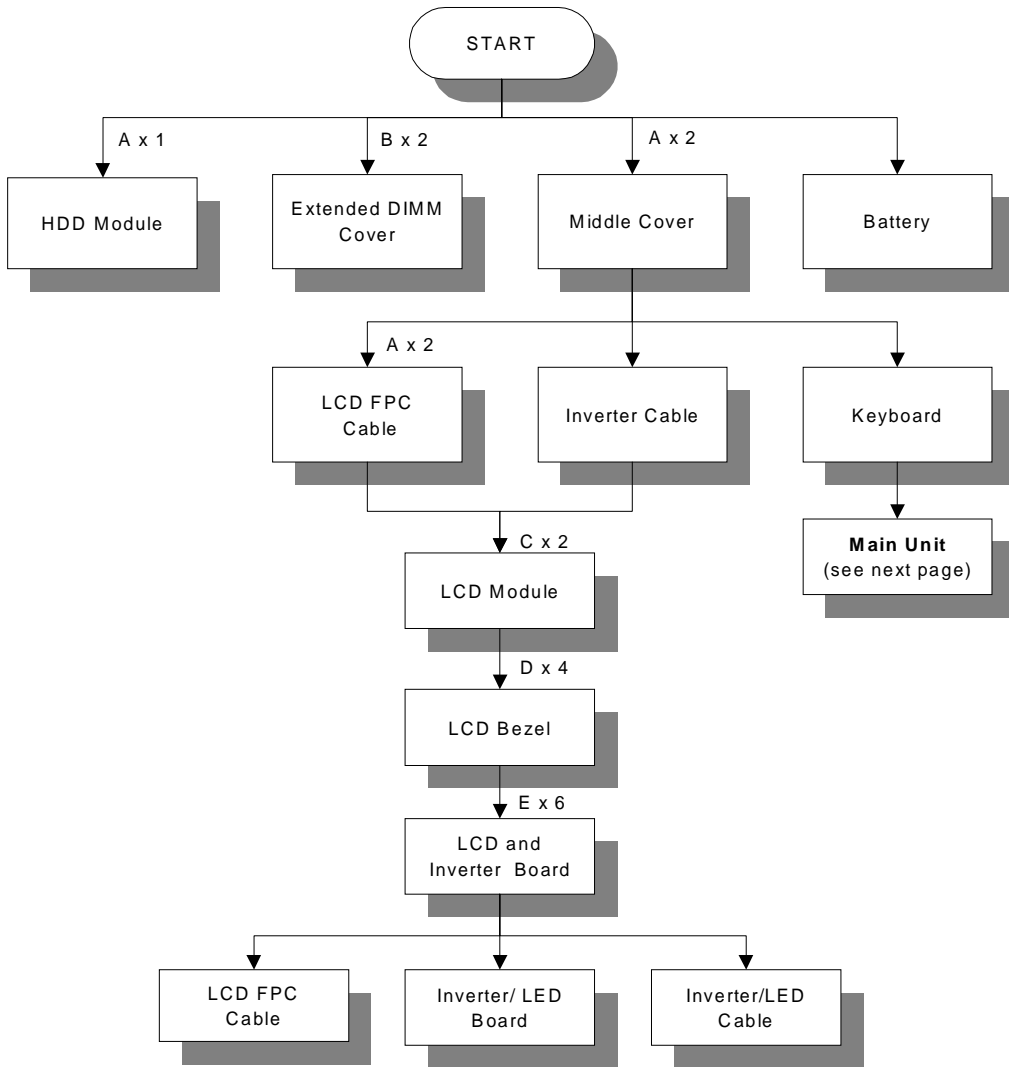

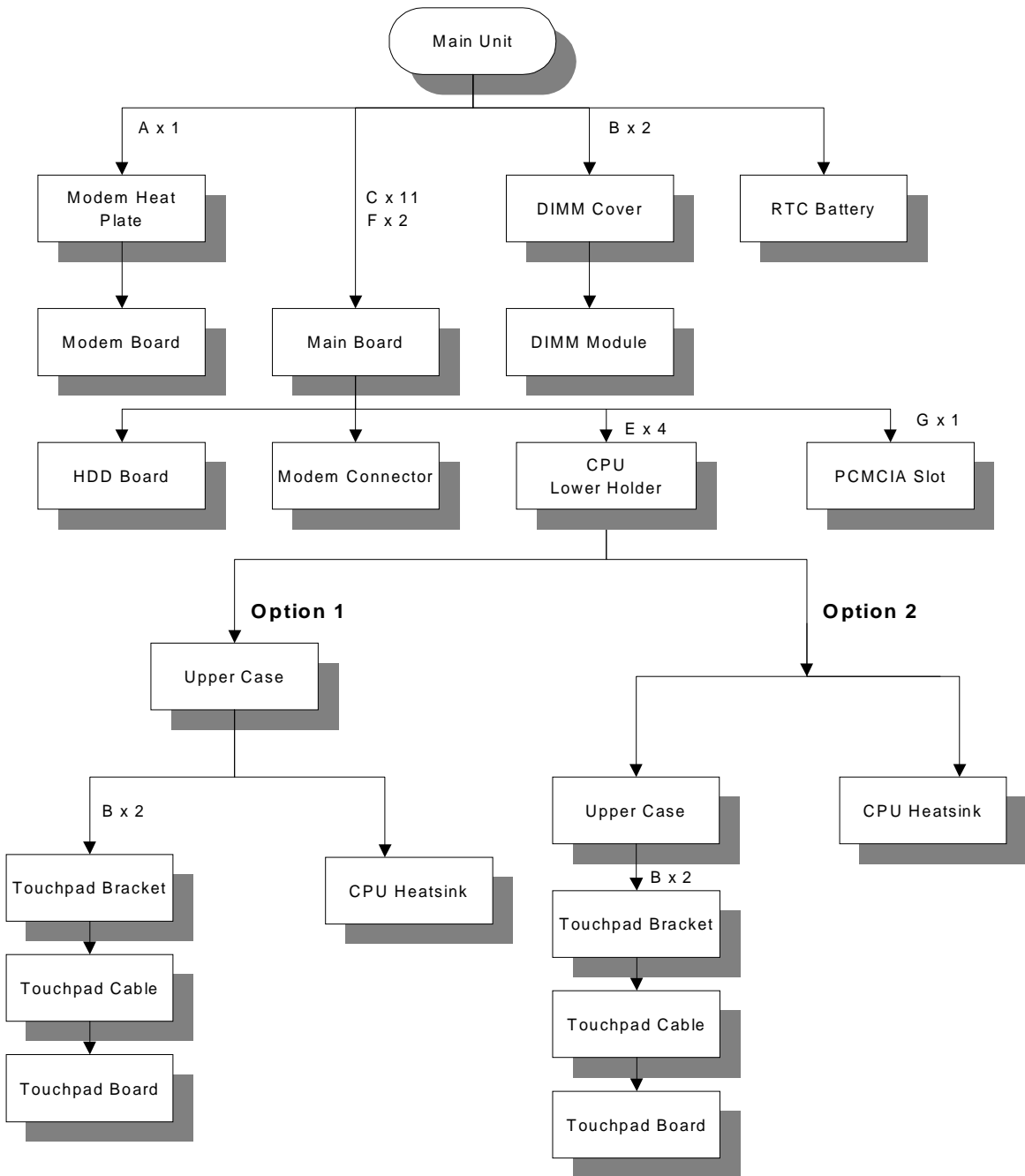

Screw List

Item	Part No.	Description
A	86.9A322.9R0	Screw M2.0X9 (Black)
B	86.9A322.4R0	Screw M2.0X4
C	86.9A353.6R0	Screw M2.5X6
D	86.9A553.5R0	Screw M2.5X5
E	86.9A323.4R0	Screw M2.5X4 (Black)
F	86.9A522.6R0	Screw M2.0X6
G	86.9A323.6R0	Screw M2.5X6 (Black)

Removing the Battery Pack

1. Push the battery release button inward.
2. Slide the battery pack out from the main unit.

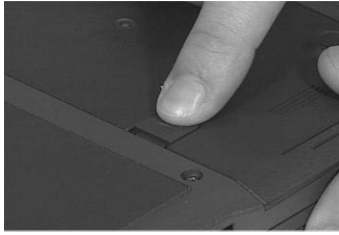

NOTE: To replace the battery pack into the main unit, be sure that the triangular point in the battery pack matches with the point in the lower case.

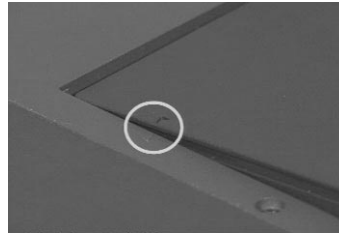

Removing the Hard Disk Drive Module

1. Remove the screw of the hard disk module.
2. Slide the hard disk module out from its bay.

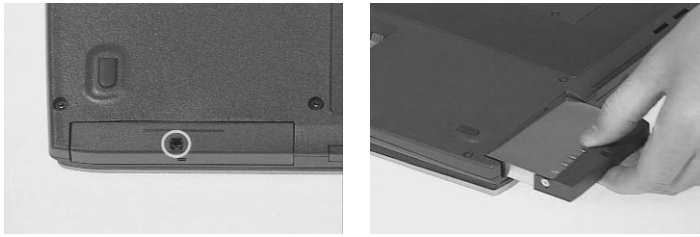

NOTE: ¹After loosening the hard disk drive screw, you must completely remove it so you can then slide out the hard disk drive. It may be a little difficult to completely remove the screw.

Disassembling the Hard Disk Drive Module

1. Gently, detach the connector from the hard disk module.

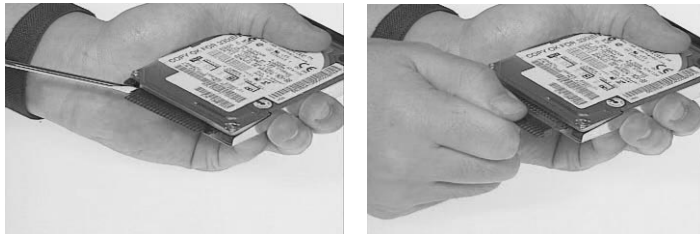

2. Remove the two screws on both sides of the hard disk module.
3. Remove the hard disk plate from the hard disk module.

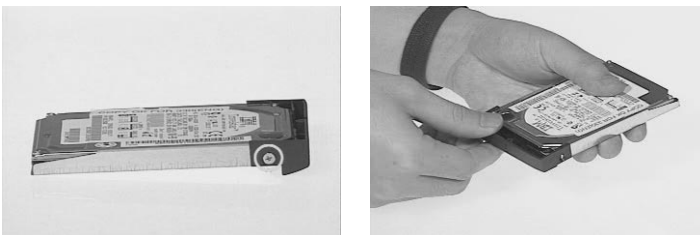

4. Slide the hard disk out from the hard disk drive bezel.
5. This completes the disassembly procedure of the hard disk drive.

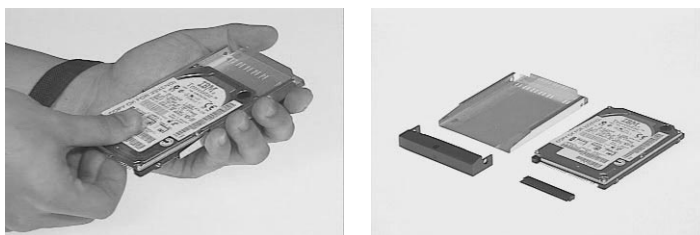

¹ New added description. Please pay attention to this note.

Removing the External DIMM Module

1. Remove the two screws holding the external DIMM cover.
2. Lift the cover out to remove the DIMM module.

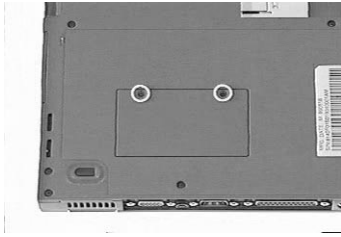

Removing the LCD Module

Removing the Middle Cover

1. First remove the two screws from the rear of the unit.
2. Push the release button to release the middle cover gently.
3. Pull the middle cover up.
4. Disconnect the speaker cable from the main board and lift the middle cover away.



Removing the Speaker

1. First, remove the screw.
2. Remove the speaker plate with the speaker from the middle cover
3. Separate the speaker plate from the speaker.

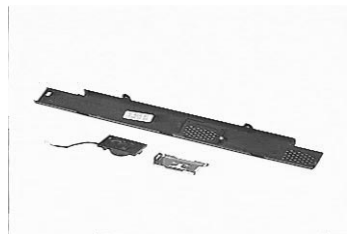
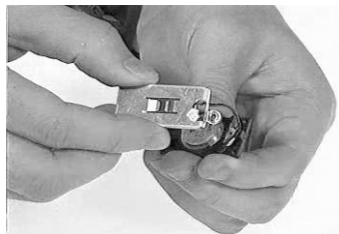
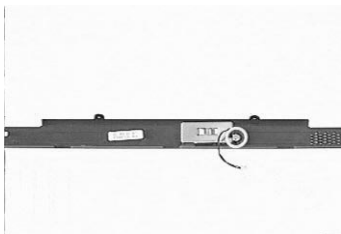

Disassembling the LCD module

1. Disconnect the inverter cable from the main board.
2. Remove the two screws from the LCD FPC cable.
3. Disconnect the LCD FPC cable from the main board.

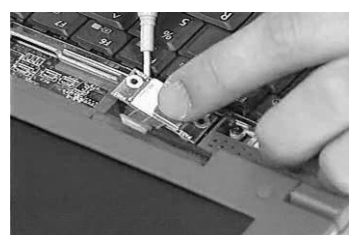
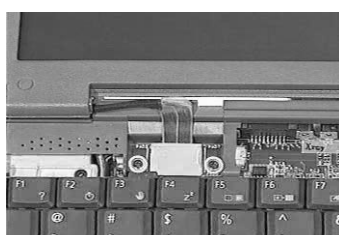

4. Close the LCD module.
5. Remove the two screws on the base of the unit
6. Open the LCD to remove the LCD module from the main unit.

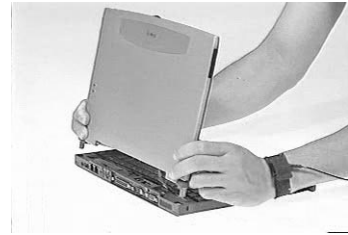
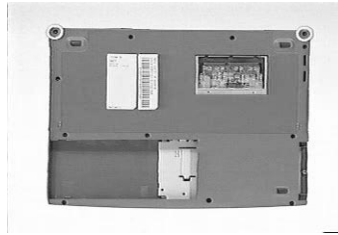
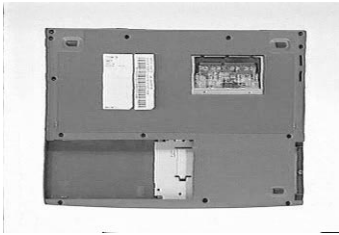

7. Remove the two camera rubbers from the LCD.
8. Remove the four cushions.
9. Remove the four screws from the LCD bezel.



10. Snap off the LCD bezel carefully and gently remove the LCD bezel from the LCD module.
11. Remove the two screws from the hinges.
12. Remove the hinges from the LCD module.

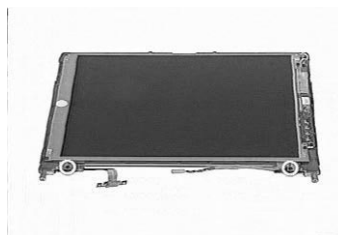

13. Detach the hinge caps from the hinges.
14. Remove the six screws from the LCD and the inverter.
15. Remove the LCD and the inverter from the LCD Panel.

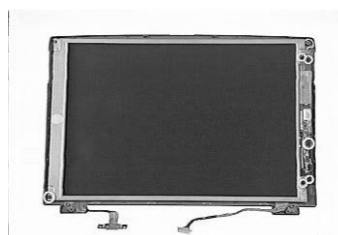
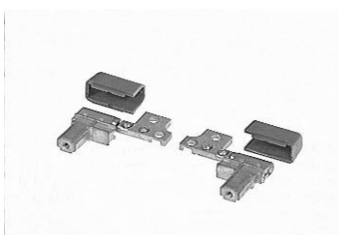

-
16. Turn the LCD over and disconnect the LCD power connector from the inverter.
 17. Disconnect the inverter cable from the inverter.
 18. Disconnect the LCD FPC cable from the LCD.

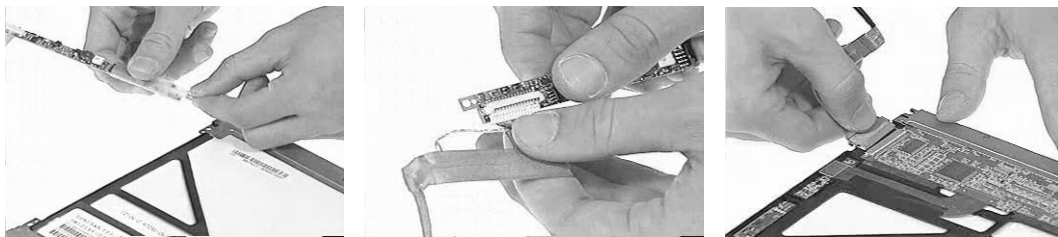

Disassembling the Main Unit

Removing the Keyboard

1. Pull out and upward to expose the keyboard.
2. Disconnect the keyboard cable from the main board.
3. Remove the keyboard from the main board.

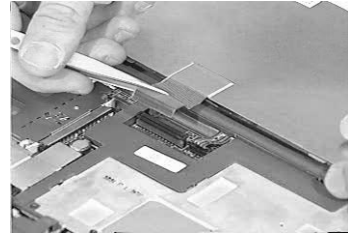
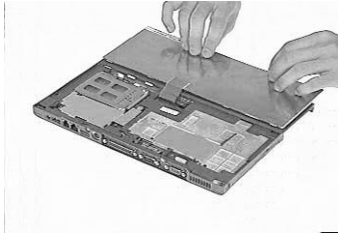

Removing the DIMM Module

1. Remove the two screws from the DIMM cover.
2. Remove the DIMM cover from the main unit.
3. Use two flat bladed screw drivers to push out the latches on both sides of the DIMM socket .
4. Remove the DIMM module from the main unit.

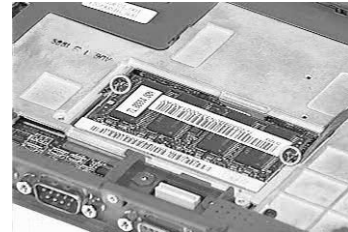
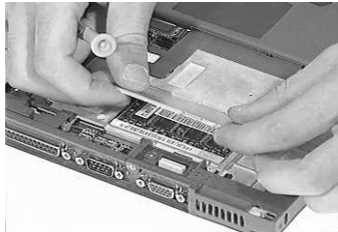
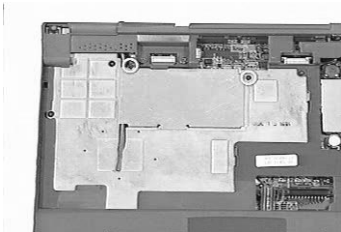

Removing the Modem Combo Board

1. Remove the screw from the modem heat sink and remove it from the main unit.
2. Use two flat bladed screw drivers to push out the latches on both sides of the modem socket.

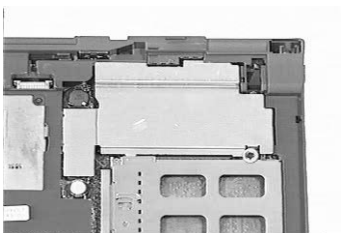

3. Pull the modem combo board out from its socket.
4. Disconnect the network cable from the modem combo board.

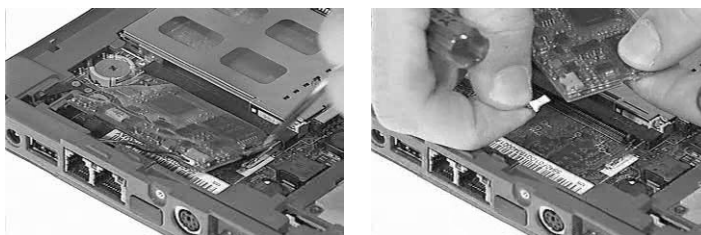

Removing the RTC

1. Use a plastic flat bladed screw driver to remove the RTC battery from its socket.



NOTE: To replace the RTC battery, press the RTC battery into the socket.

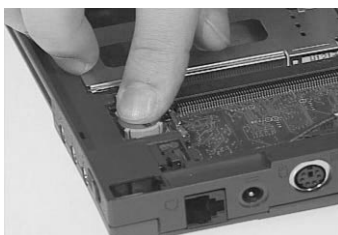

Removing the Lower Case

1. Remove the three screws, and the 11 screws on the base of the unit .
2. Remove the lower case from the main unit.

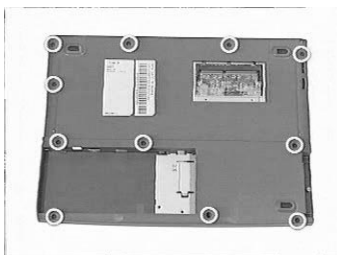
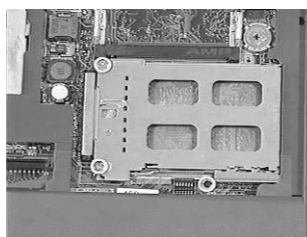

3. Disconnect the touch pad cable from the main board.
4. Turn the unit over to remove the 4 screws on the CPU lower holder.
5. Remove the CPU lower holder from the main board.

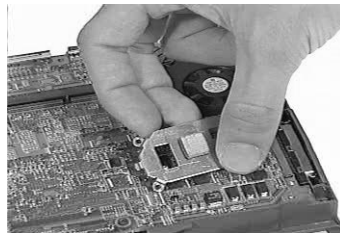
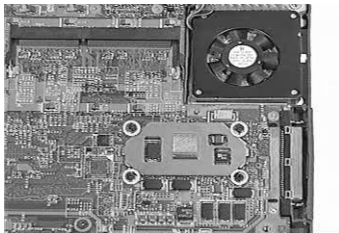
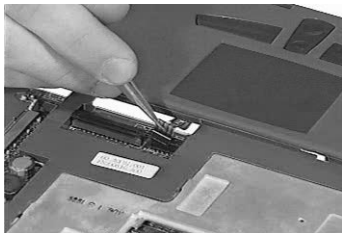

Removing the Main Board

1. Remove the 4 screws on the mother board as shown below.
2. Turn the main board over and put it on the side of the upper case.
3. Remove then fan cable from the main board.
4. Remove the main board from the upper case.

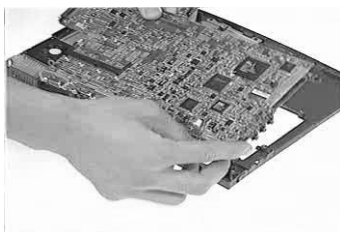
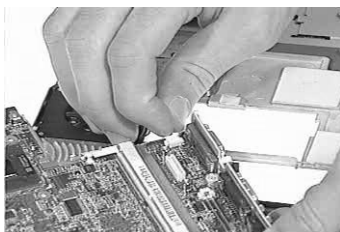
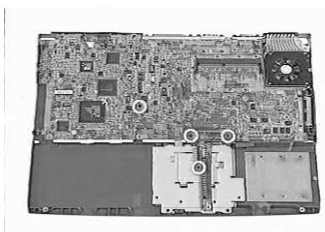

5. Remove the harddisk drive board from the main board.
6. Gently, remove the PCMCIA slot from the main board by hand.

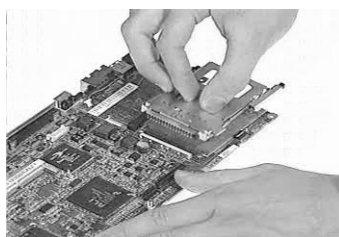
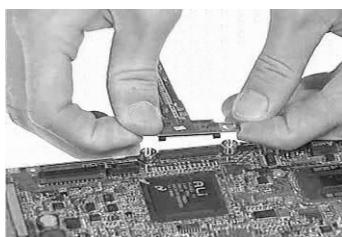

Removing the Touchpad Board

1. Remove the two screws from the touchpad bracket.
2. Remove the touchpad bracket from the upper case.
3. Disconnect the touchpad cable from the touchpad board.
4. Remove the touchpad board from the upper case.

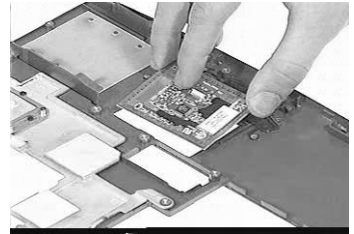
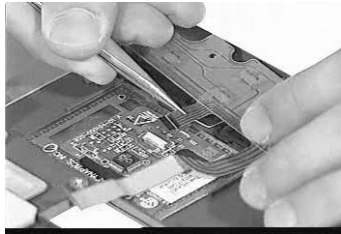
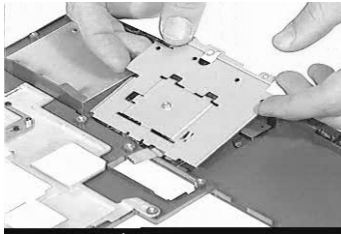

Troubleshooting

Use the following procedure as a guide for computer problems.

NOTE: The diagnostic tests are intended to test only Acer products. Non-Acer products, prototype cards, or modified options can give false errors and invalid system responses.

1. Obtain the failing symptoms in as much detail as possible.
2. Verify the symptoms by attempting to re-create the failure by running the diagnostic test or by repeating the same operation.
3. Use the following table with the verified symptom to determine which page to go to.

Symptoms (Verified)	Go To
Power failure. (The power indicator does not go on or stay on.)	"Power System Check" on page 55.
POST does not complete. No beep or error codes are indicated.	"Power-On Self-Test (POST) Error Message" on page 57 "Undetermined Problems" on page 63
POST detects an error and displayed messages on screen.	"Error Message List" on page 58
The diagnostic test detected an error and displayed a FRU code.	"Running PQA Diagnostics Program" on page 37
Other symptoms (i.e. LCD display problems or others).	"Power-On Self-Test (POST) Error Message" on page 57
Symptoms cannot be re-created (intermittent problems).	Use the customer-reported symptoms and go to "Power-On Self-Test (POST) Error Message" on page 57 "Intermittent Problems" on page 63 "Undetermined Problems" on page 63

System Check Procedures

External Diskette Drive Check

Do the following to isolate the problem to a controller, driver, or diskette. A write-enabled, diagnostic diskette is required.

NOTE: Make sure that the diskette does not have more than one label attached to it. Multiple labels can cause damage to the drive or cause the drive to fail.

Do the following to select the test device. See “Running PQA Diagnostics Program” on page 37 for details.

1. Boot from the diagnostics diskette and start the PQA program (see “Running PQA Diagnostics Program” on page 37).
2. Go to the diagnostic Diskette Drive in the test items.
3. Press F2 in the test items.
4. Follow the instructions in the message window.

If an error occurs with the internal diskette drive, reconnect the diskette connector on the system board.

If the error still remains:

1. Reconnect the external diskette drive/CD-ROM module.
2. Replace the external diskette drive/CD-ROM module.
3. Replace the system board.

External CD-ROM Drive Check

Do the following to isolate the problem to a controller, drive, or CD-ROM. Make sure that the CD-ROM does not have any label attached to it. The label can cause damage to the drive or can cause the drive to fail.

Do the following to select the test device:

1. Boot from the diagnostics diskette and start the PQA program (refer to “Running PQA Diagnostics Program” on page 37).
2. Go to the diagnostic CD-ROM in the test items.
3. Press F2 in the test items.
4. Follow the instructions in the message window.

If an error occurs, reconnect the connector on the System board. If the error still remains:

1. Reconnect the external diskette drive/CD-ROM module.
2. Replace the external diskette drive/CD-ROM module.
3. Replace the system board.

Keyboard or Auxiliary Input Device Check

Remove the external keyboard if the internal keyboard is to be tested.

If the internal keyboard does not work or an unexpected character appears, make sure that the flexible cable extending from the keyboard is correctly seated in the connector on the system board.

If the keyboard cable connection is correct, run the Keyboard Test. See “Running PQA Diagnostics Program” on page 37 for details.

If the tests detect a keyboard problem, do the following one at a time to correct the problem. Do not replace a non-defective FRU:

1. Reconnect the keyboard cables.
2. Replace the keyboard.
3. Replace the system board.

The following auxiliary input devices are supported by this computer:

- Numeric keypad
- External keyboard

If any of these devices do not work, reconnect the cable connector and repeat the failing operation.

Memory Check

Memory errors might stop system operations, show error messages on the screen, or hang the system.

1. Boot from the diagnostics diskette and start the PQA program (please refer to “Running PQA Diagnostics Program” on page 37).
2. Go to the diagnostic memory in the test items.
3. Press F2 in the test items.
4. Follow the instructions in the message window.

NOTE: Make sure that the DIMM is fully installed into the connector. A loose connection can cause an error.

Power System Check

To verify the symptom of the problem, power on the computer using each of the following power sources:

1. Remove the battery pack.
2. Connect the power adapter and check that power is supplied.
3. Disconnect the power adapter and install the charged battery pack; then check that power is supplied by the battery pack.

If you suspect a power problem, see the appropriate power supply check in the following list:

- “Check the Power Adapter” on page 55
- “Check the Battery Pack” on page 55

Check the Power Adapter

Unplug the power adapter cable from the computer and measure the output voltage at the plug of the power adapter cable. See the following figure

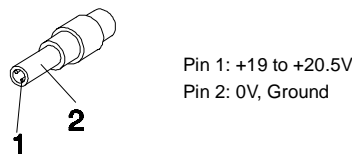

1. If the voltage is not correct, replace the power adapter.
2. If the voltage is within the range, do the following:
 - Replace the System board.
 - If the problem is not corrected, see “Undetermined Problems” on page 63.
 - If the voltage is not correct, go to the next step.

NOTE: An audible noise from the power adapter does not always indicate a defect.

3. If the power-on indicator does not light up, check the power cord of the power adapter for correct continuity and installation.
4. If the operational charge does not work, see “Check the Battery Pack” on page 55.

Check the Battery Pack

To check the battery pack, do the following:

1. Power off the computer.

2. Remove the battery pack and measure the voltage between battery terminals 1(+) and 6(ground). See the following figure

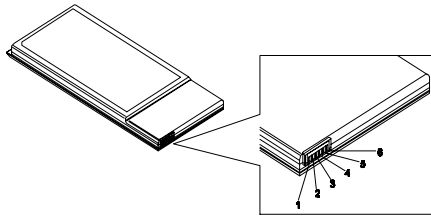

3. If the voltage is still less than 7.2 Vdc after recharging, replace the battery.

To check the battery charge operation, use a discharged battery pack or a battery pack that has less than 50% of the total power remaining when installed in the computer.

If the battery status indicator does not light up, remove the battery pack and let it return to room temperature. Re-install the battery pack.

If the charge indicator still does not light up, replace the battery pack. If the charge indicator still does not light up, replace the DC/DC charger board.

Touchpad Check

If the touchpad doesn't work, do the following actions one at a time to correct the problem. Do not replace a non-defective FRU:

1. Reconnect the touchpad cables.
2. Replace the touchpad.
3. Replace the system board.

After you use the touchpad, the pointer drifts on the screen for a short time. This self-acting pointer movement can occur when a slight, steady pressure is applied to the touchpad pointer. This symptom is not a hardware problem. No service actions are necessary if the pointer movement stops in a short period of time.

Power-On Self-Test (POST) Error Message

The POST error message index lists the error message and their possible causes. The most likely cause is listed first.

NOTE: Perform the FRU replacement or actions in the sequence shown in FRU/Action column, if the FRU replacement does not solve the problem, put the original part back in the computer. Do not replace a non-defective FRU.

This index can also help you determine the next possible FRU to be replaced when servicing a computer.

If the symptom is not listed, see “Undetermined Problems” on page 63.

The following lists the error messages that the BIOS displays on the screen and the error symptoms classified by function.

NOTE: Most of the error messages occur during POST. Some of them display information about a hardware device, e.g., the amount of memory installed. Others may indicate a problem with a device, such as the way it has been configured.

NOTE: If the system fails after you make changes in the BIOS Setup Utility menus, reset the computer, enter Setup and install Setup defaults or correct the error.

Index of Error Messages

Error Message List

Error Messages	FRU/Action in Sequence
Failure Fixed Disk	Reconnect hard disk drive connector. "Load Default Settings" in BIOS Setup Utility. Hard disk drive System board
Stuck Key	see "Keyboard or Auxiliary Input Device Check" on page 54 .
Keyboard error	see "Keyboard or Auxiliary Input Device Check" on page 54.
Keyboard Controller Failed	see "Keyboard or Auxiliary Input Device Check" on page 54.
Keyboard locked - Unlock key switch	Unlock external keyboard
Monitor type does not match CMOS - Run Setup	Run "Load Default Settings" in BIOS Setup Utility.
Shadow RAM Failed at offset: nnnn	BIOS ROM System board
System RAM Failed at offset: nnnn	DIMM System board
Extended RAM Failed at offset: nnnn	DIMM System board
System battery is dead - Replace and run Setup	Replace RTC battery and Run BIOS Setup Utility to reconfigure system time, then reboot system.
System CMOS checksum bad - Default configuration used	RTC battery Run BIOS Setup Utility to reconfigure system time, then reboot system.
System timer error	RTC battery Run BIOS Setup Utility to reconfigure system time, then reboot system. System board
Real time clock error	RTC battery Run BIOS Setup Utility to reconfigure system time, then reboot system. System board
Previous boot incomplete - Default configuration used	Run "Load Default Settings" in BIOS Setup Utility. RTC battery System board
Memory size found by POST differed from CMOS	Run "Load Default Settings" in BIOS Setup Utility. DIMM System board
Diskette drive A error	Check the drive is defined with the proper diskette type in BIOS Setup Utility See "External Diskette Drive Check" on page 54.
Incorrect Drive A type - run SETUP	Check the drive is defined with the proper diskette type in BIOS Setup Utility See "External Diskette Drive Check" on page 54.
System cache error - Cache disabled	System board
CPU ID:	System board
DMA Test Failed	DIMM System board
Software NMI Failed	DIMM System board
Fail-Safe Timer NMI Failed	DIMM System board

Error Message List

Error Messages	FRU/Action in Sequence
Device Address Conflict	Run "Load Default Settings" in BIOS Setup Utility. RTC battery System board
Allocation Error for device	Run "Load Default Settings" in BIOS Setup Utility. RTC battery System board
Failing Bits: nnnn	DIMM BIOS ROM System board
Fixed Disk n	None
Invalid System Configuration Data	BIOS ROM System board
I/O device IRQ conflict	Run "Load Default Settings" in BIOS Setup Utility. RTC battery System board
Operating system not found	Enter Setup and see if fixed disk and drive A: are properly identified. Diskette drive Hard disk drive System board

Error Message List

No beep Error Messages	FRU/Action in Sequence
No beep, power-on indicator turns off and LCD is blank.	Power source (battery pack and power adapter). See "Power System Check" on page 55. Ensure every connector is connected tightly and correctly. Reconnect the DIMM. LED board. System board.
No beep, power-on indicator turns on and LCD is blank.	Power source (battery pack and power adapter). See "Power System Check" on page 55. Reconnect the LCD connector Hard disk drive LCD inverter ID LCD cable LCD Inverter LCD System board
No beep, power-on indicator turns on and LCD is blank. But you can see POST on an external CRT.	Reconnect the LCD connectors. LCD inverter ID LCD cable LCD inverter LCD System board
No beep, power-on indicator turns on and a blinking cursor shown on LCD during POST.	Ensure every connector is connected tightly and correctly. System board
No beep during POST but system runs correctly.	Speaker System board

Index of Symptom-to-FRU Error Message

LCD-Related Symptoms

Symptom / Error	Action in Sequence
LCD backlight doesn't work LCD is too dark LCD brightness cannot be adjusted LCD contrast cannot be adjusted	Enter BIOS Utility to execute "Load Setup Default Settings", then reboot system. Reconnect the LCD connectors. Keyboard (if contrast and brightness function key doesn't work). LCD inverter ID LCD cable LCD inverter LCD System board
Unreadable LCD screen Missing pels in characters Abnormal screen Wrong color displayed	Reconnect the LCD connector LCD inverter ID LCD cable LCD inverter LCD System board
LCD has extra horizontal or vertical lines displayed.	LCD inverter ID LCD inverter LCD cable LCD System board

Indicator-Related Symptoms

Symptom / Error	Action in Sequence
Indicator incorrectly remains off or on, but system runs correctly	Reconnect the inverter board Inverter board System board

Power-Related Symptoms

Symptom / Error	Action in Sequence
Power shuts down during operation	Power source (battery pack and power adapter). See "Power System Check" on page 55. Battery pack Power adapter Hard drive & battery connection board System board
The system doesn't power-on.	Power source (battery pack and power adapter). See "Power System Check" on page 55. Battery pack Power adapter Hard drive & battery connection board System board
The system doesn't power-off.	Power source (battery pack and power adapter). See "Power System Check" on page 55. Hold and press the power switch for more than 4 seconds. System board
Battery can't be charged	See "Check the Battery Pack" on page 55. Battery pack System board

PCMCIA-Related Symptoms

Symptom / Error	Action in Sequence
System cannot detect the PC Card (PCMCIA)	PCMCIA slot assembly System board
PCMCIA slot pin is damaged.	PCMCIA slot assembly

Memory-Related Symptoms

Symptom / Error	Action in Sequence
Memory count (size) appears different from actual size.	Enter BIOS Setup Utility to execute "Load Default Settings, then reboot system. DIMM System board

Speaker-Related Symptoms

Symptom / Error	Action in Sequence
In Windows, multimedia programs, no sound comes from the computer.	Audio driver Speaker System board
Internal speakers make noise or emit no sound.	Speaker System board

Power Management-Related Symptoms

Symptom / Error	Action in Sequence
The system will not enter hibernation	Keyboard (if control is from the keyboard) Hard disk drive System board
The system doesn't enter hibernation mode and four short beeps every minute.	See "Hibernation Mode" on page 22. Press Fn+F4 and see if the computer enters hibernation mode. Touchpad Keyboard Hard disk connection board Hard disk drive System board
The system doesn't enter standby mode after closing the LCD	See "Standby Mode" on page 22. LCD cover switch System board
The system doesn't resume from hibernation mode.	See "Hibernation Mode" on page 22. Hard disk connection board Hard disk drive System board
The system doesn't resume from standby mode after opening the LCD.	See "Standby Mode" on page 22. LCD cover switch System board
Battery fuel gauge in Windows doesn't go higher than 90%.	Remove battery pack and let it cool for 2 hours. Refresh battery (continue use battery until power off, then charge battery). Battery pack System board

Power Management-Related Symptoms

Symptom / Error	Action in Sequence
System hangs intermittently.	See "Thermal and Fan Utility" on page 35. Reconnect hard disk/CD-ROM drives. Hard disk connection board System board

Peripheral-Related Symptoms

Symptom / Error	Action in Sequence
System configuration does not match the installed devices.	Enter BIOS Setup Utility to execute "Load Default Settings", then reboot system. Reconnect hard disk/CD-ROM/diskette drives.
External display does not work correctly.	Press Fn+F5, LCD/CRT/Both display switching See "Running PQA Diagnostics Program" on page 37. System board
USB does not work correctly	See "Running PQA Diagnostics Program" on page 37 System board
Print problems.	Ensure the "Parallel Port" in the "Onboard Devices Configuration" of BIOS Setup Utility is set to Enabled. Onboard Devices Configuration Run printer self-test. Printer driver Printer cable Printer System Board
Serial or parallel port device problems.	Ensure the "Serial Port" in the Devices Configuration" of BIOS Setup Utility is set to Enabled. Device driver Device cable Device System board

Keyboard/Touchpad-Related Symptoms

Symptom / Error	Action in Sequence
Keyboard (one or more keys) does not work.	Reconnect the keyboard cable. Keyboard System board
Touchpad does not work.	Reconnect touchpad cable. Touchpad board System board

Modem-Related Symptoms

Symptom / Error	Action in Sequence
Internal modem does not work correctly.	See "System Diagnostic Diskette" on page 36. Modem phone port modem combo board System board

NOTE: If you cannot find a symptom or an error in this list and the problem remains, see "Undetermined Problems" on page 63.

Intermittent Problems

Intermittent system hang problems can be caused by a variety of reasons that have nothing to do with a hardware defect, such as: cosmic radiation, electrostatic discharge, or software errors. FRU replacement should be considered only when a recurring problem exists.

When analyzing an intermittent problem, do the following:

1. Run the advanced diagnostic test for the system board in loop mode at least 10 times.
2. If no error is detected, do not replace any FRU.
3. If any error is detected, replace the FRU. Rerun the test to verify that there are no more errors.

Undetermined Problems

The diagnostic problems does not identify which adapter or device failed, which installed devices are incorrect, whether a short circuit is suspected, or whether the system is inoperative.

Follow these procedures to isolate the failing FRU (do not isolate non-defective FRU).

NOTE: Verify that all attached devices are supported by the computer.

NOTE: Verify that the power supply being used at the time of the failure is operating correctly. (See “Power System Check” on page 55):

1. Power-off the computer.
2. Visually check them for damage. If any problems are found, replace the FRU.
3. Remove or disconnect all of the following devices:
 - Non-Acer devices
 - Printer, mouse, and other external devices
 - Battery pack
 - Hard disk drive
 - DIMM
 - CD-ROM/Floppy diskette drive Module
 - PC Cards
4. Power-on the computer.
5. Determine if the problem has changed.
6. If the problem does not recur, reconnect the removed devices one at a time until you find the failing FRU.
7. If the problem remains, replace the following FRU one at a time. Do not replace a non-defective FRU:
 - System board
 - LCD assembly

Index of AFlash BIOS Error Message

Error Message	Action in Sequence
Hardware Error	See "System Diagnostic Diskette" on page 36
VPD Checksum Error	Reboot the system and then retest with this diskette.
BIOS Update Program Error	Turn off the power and restart the system.
System Error	Make sure this AFlash BIOS diskette for this model.
Without AC adapter	make sure to connect AC adapter
Battery Low	make sure to install a highly charged battery, and reboot system.

Index of PQA Diagnostic Error Code, Message

Error Code	Message	Action in Sequence
16XXX	Backup battery error	Backup battery
01XXX	CPU or main board error	Reload BIOS default setting. System board
02XXX	Memory error	DIMM System board
03XXX	Keyboard error	Reset Keyboard Keyboard System board
04XXX	Video error	System board
05XXX	Parallel Port error	System board
06XXX	Serial port or main board error	System board
07XXX	Diskette drive error	Diskette drive System board
08XXX	Hard disk error	Reload BIOS default setting Hard disk System board
09XXX	CD-ROM error	Reset CD-ROM cable CD-ROM drive System board
10XXX	Co-processor error	System board
11XXX	Pointing device error	Reset Keyboard Keyboard System board
12XXX	Cache test error	System board

Jumper and Connector Information

Top View

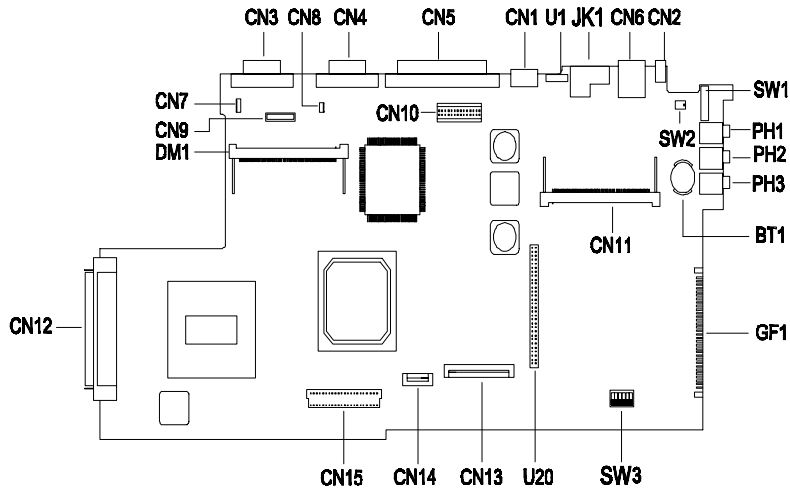

PCB 99203

CN1	PS/2 Port	CN15	HDD Board Connector
CN2	AC Adapter Connector	JK1	LAN/Modem Connector
CN3	Video Port	SW1	Power Switch
CN4	Serial Port	SW2	LCD Cover Switch Connector
CN5	Parallel Port	SW3	See SW3 Setting
CN6	USB Port	PH1	Line-out port
CN7	FAN Connector	PH2	Line-in port
CN8	Speaker	PH3	Microphone-in Port
CN9	LCD Connector	DM1	DIMM Socket 1
CN10	LED/Inverter Board Connector	U1	FIR Port
CN11	Mini PCI Card Connector	U20	PCMCIA Socket
CN12	External FDD, CD/DVD-ROM Module Connector	GF1	Golden Finger for Debug Board
CN13	Internal Keyboard Connector	BT1	RTC Battery
CN14	Touchpad Connector		

SW3 Settings

SW3	Setting
Switch 1, Switch 2, Switch 3	OFF, OFF, OFF: English keyboard ON, OFF, OFF: Japanese keyboard OFF, ON, OFF: European keyboard
Switch 4, Switch 5	OFF, OFF: Acer BIOS ON, OFF: OEM BIOS
Switch 6	ON: Bypass password OFF: Check password

Bottom View

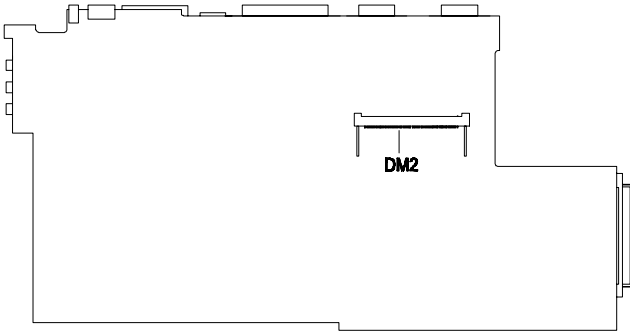

DM2

DIMM Socket 2

FRU (Field Replaceable Unit) List

This chapter gives you the FRU (Field Replaceable Unit) listing in global configurations of TravelMate 340. Refer to this chapter whenever ordering for parts to repair or for RMA (Return Merchandise Authorization).

Please note WHEN ORDERING FRU PARTS, that should check the most up-to-date information available on your regional web or channel. For whatever reasons a part number change is made, it will not be noted on the printed Service Guide. For ACER AUTHORIZED SERVICE PROVIDERS, your Acer office may have a DIFFERENT part number code to those given in the FRU list of this printed Service Guide. You MUST use the local FRU list provided by your regional Acer office to order FRU parts for repair and service of customer machines.

NOTE: To scrap or to return the defective parts, you should follow the local government ordinance or regulations on how to dispose it properly, or follow the rules set by your regional Acer office on how to return it.

NOTE: The number indicates the location shown on exploded diagrams or “NS” indicates “Not Shown” on it.

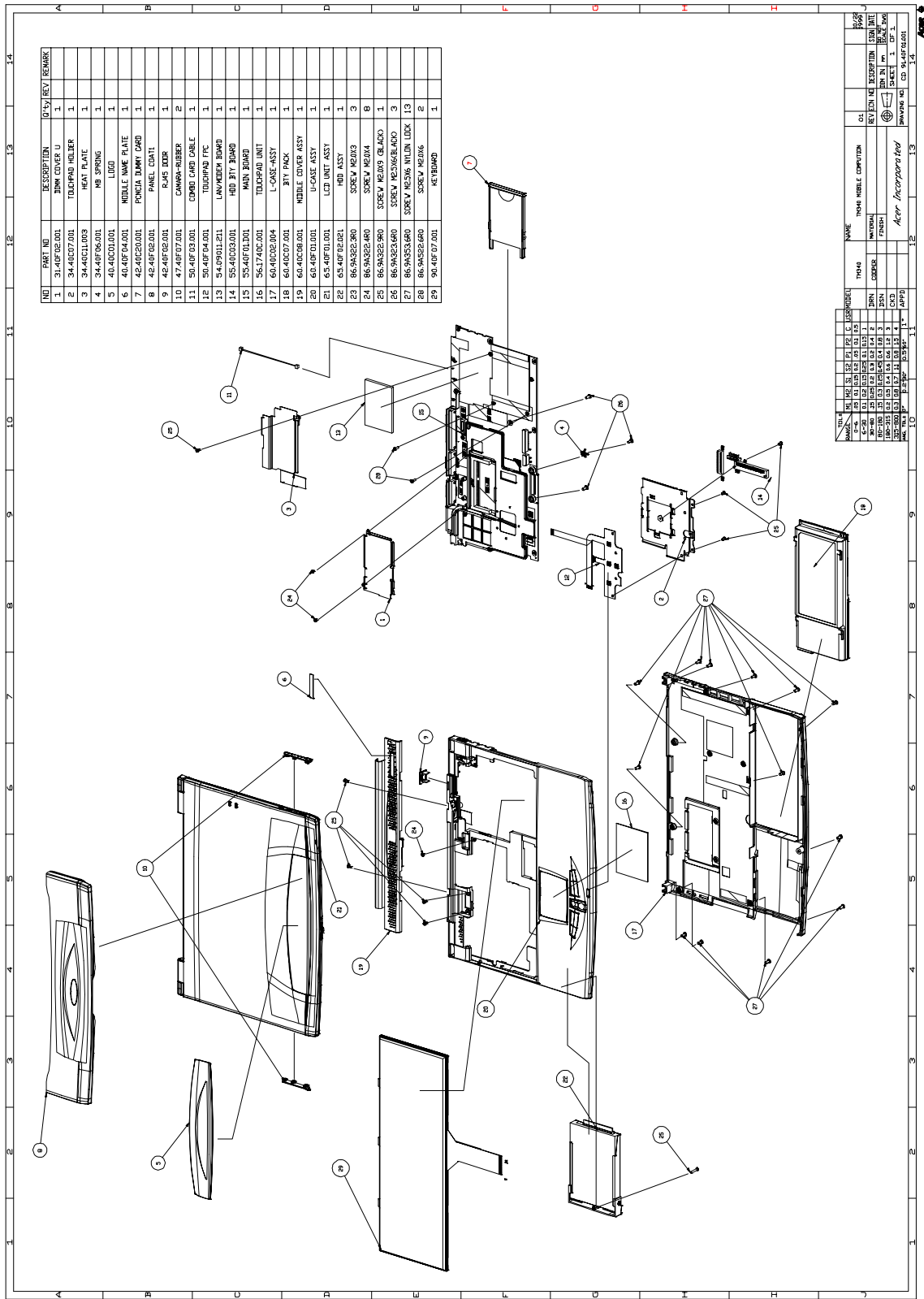

PNL	PART NO.	DESCRIPTION	QTY	REV	REMARK
1	31.40F02.001	BIWM COVER U	1		
2	34.4A007.001	TOUCHPAD HOLDER	1		
3	34.4A011.003	HEAT PLATE	1		
4	34.4A016.001	MB SPRING	1		
5	40.40001.001	LOGO	1		
6	40.40F04.001	MOBILE WARE PLATE	1		
7	42.4A023.001	PONCHA TUMMY CARD	1		
8	42.4A023.001	PANEL GRATE	1		
9	42.4A023.001	R.HAS COVER	1		
10	47.4A027.001	CAMERA RUBBER	2		
11	50.4A029.001	COMB CARD CABLE	1		
12	50.4A029.001	TOUCHPAD FPC	1		
13	54.09111.211	UNIVERSAL BOARD	1		
14	55.4A030.001	HDD BTT BOARD	1		
15	55.4A030.001	MAIN BOARD	1		
16	55.4A030.001	TOUCHPAD UNIT	1		
17	60.4A002.004	L-CASE ASSY	1		
18	60.4A007.001	BTT PACK	1		
19	60.4A008.001	MIDDLE COVER ASSY	1		
20	60.4A010.001	U-CASE ASSY	1		
21	63.4A012.001	LCD UNIT ASSY	1		
22	63.4A012.001	HDD ASSY	1		
23	86.9A022.900	SCREW M2.0X3	3		
24	86.9A022.900	SCREW M2.0X4	8		
25	86.9A022.900	SCREW M2.0X9 CLACKO	1		
26	86.9A023.600	SCREW M2.0X6/BLACKO	3		
27	86.9A033.600	SCREW M2.0X6 NYLON LOCK	13		
28	86.9A022.600	SCREW M2.0X6	2		
29	90.4A017.001	KEY BOARD	1		

DATE	TIME	BY	CHK	APP	REV	DESCRIPTION	REV	DATE	BY	CHK	APP
10/20/01	10:30	WJ	WJ	WJ	1	INITIAL					
10/20/01	10:30	WJ	WJ	WJ	2	CHANGE					
10/20/01	10:30	WJ	WJ	WJ	3	LOCK					
10/20/01	10:30	WJ	WJ	WJ	4	APPRO					

NAME	TH014	TH014	TH014
TH014	TH014	TH014	TH014
TH014	TH014	TH014	TH014
TH014	TH014	TH014	TH014

NAME	TH014	TH014	TH014
TH014	TH014	TH014	TH014
TH014	TH014	TH014	TH014
TH014	TH014	TH014	TH014

NAME	TH014	TH014	TH014
TH014	TH014	TH014	TH014
TH014	TH014	TH014	TH014
TH014	TH014	TH014	TH014

NAME	TH014	TH014	TH014
TH014	TH014	TH014	TH014
TH014	TH014	TH014	TH014
TH014	TH014	TH014	TH014

NAME	TH014	TH014	TH014
TH014	TH014	TH014	TH014
TH014	TH014	TH014	TH014
TH014	TH014	TH014	TH014

NAME	TH014	TH014	TH014
TH014	TH014	TH014	TH014
TH014	TH014	TH014	TH014
TH014	TH014	TH014	TH014

NAME	TH014	TH014	TH014
TH014	TH014	TH014	TH014
TH014	TH014	TH014	TH014
TH014	TH014	TH014	TH014



NAME	TH014	TH014	TH014
TH014	TH014	TH014	TH014
TH014	TH014	TH014	TH014
TH014	TH014	TH014	TH014

NAME	TH014	TH014	TH014
TH014	TH014	TH014	TH014
TH014	TH014	TH014	TH014
TH014	TH014	TH014	TH014

NAME	TH014	TH014	TH014
TH014	TH014	TH014	TH014
TH014	TH014	TH014	TH014
TH014	TH014	TH014	TH014







NAME	TH014	TH014	TH014
TH014	TH014	TH014	TH014
TH014	TH014	TH014	TH014
TH014	TH014	TH014	TH014





Picture	No.	Part Name	Description	Part No.
LCD				
	NS	LCD ASSEMBLY MODULE (12.1") TORISAN	ASSY LCD MODULE 12.1" TFT TM340 TORISAN	6M.40F01.001
	NS	LCD 12.1" TFT TORISAN	LCD-LVDS 12.1" TFT TORISAN	56.0740C.011
	NS	INVERTER/AMBIT	INVERTER T62.123.C.01 V.2A 330	19.21030.901
	NS	INVERTER/SUMITA	INVERTER IV12149/T TM340	19.21042.001
	NS	INVERTER CABLE/Hua-Chen	C.A INV 20/15P 175MM TM330	50.40C02.002
	NS	LCD FPC CABLE/Hua-Chen	C.A LCD COAXIAL (SANYO) TM340	50.40F02.001
	NS	LCD FPC CABLE	C.A LCD COAXIAL (SANYO) FAV TM340	50.40F02.011
	NS	HINGE PACK	ASSY HINGE PACK TM340	6K.40C01.001
	NS	HINGE	HINGE LCD L STEEL 330	34.40C06.002
	NS	HINGE	HINGE LCD R STEEL 330	34.40C05.002
	NS	LCD PANEL TFT	ASSY LCD PANEL TM340	60.40F08.001

Picture	No.	Part Name	Description	Part No.
	NS	LCD BEZEL TFT	ASSY LCD BEZEL 12.1" TM340	60.40F09.001
DIMM				
	NS	DIMM 32MB SDRAM/ Mitsubishi	SDIMM 32M MH4S64BBKG-8 PC100 (MITSUBISHI)	72.00464.00N
	NS	DIMM 32MB SDRAM/ Siemens	SDIMM 32M HYS64V4200GDL-8 (SIEMENS)	72.64420.A0N
	NS	DIMM 64MB SDRAM/ Winbond	SODIMM 64M W9864CASB-75 (WINBOND)	72.W9864.00N
	NS	DIMM 64MB SDRAM/ Mitsubishi	SODIMM 64M 8*16 MH8S64VS-8TA (MITSUBISHI)	72.08S64.B0N
	NS	DIMM 64MB SDRAM/ Mitsubishi	SDIMM 64M MH8S64AW-10WA (MITSUBISHI)	72.00864.00N
	NS	DIMM 64MB SDRAM/ Siemens	SDIMM 64M HYS64V8220GCDL-8 (SIEMENS)	72.64820.B0N
	NS	DIMM 128MB SDRAM/ Winbond	SODIMM 128M W9812CASB-75 (WINBOND)	72.W9812.00N
	NS	DIMM 128MB SDRAM/ Mitsubishi	SODIMM 128M MH16S64VS-8TA (MITSUBISHI)	72.16S64.A0N
	NS	DIMM 128MB SDRAM/NEC	SODIMM 128M W17128IHNC86220 (NEC)	72.17128.00N
Storage Device				
	NS	HDD ASSEMBLY 6G IBM	ASSY HDD MODULE 6G TM340	6M.40F02.001
	NS	6G HDD DARA206000 IBM	HDD SM 9.5"6G IBM/DARA206000	56.02A02.041
	NS	HDD ASSEMBLY 9G IBM	ASSY HDD MODULE 9G TM340	6M.40F02.002

Picture	No.	Part Name	Description	Part No.
	NS	9G HDD DARA-209000 IBM	HDD SM 9.5" 9G IBM/DARA-209000	56.02962.161
	NS	HDD HOUSING ASSEMBLY TM330	ASSY HDD PLT TM330	60.40C15.001
	NS	HDD PLATE	PLT HDD METAL TM330	34.40C12.001
	NS	HDD BEZEL	BZL HDD PC M010 330	41.40C01.002
PCB				
	13	PCI MODEM/LAN BOARD/ AMBIT	MDM/LAN 56K AMBIT/T60.082.C.00	54.09051.001
	NS	PCI MODEM BOARD/ AMBIT	MODEM INT 56K AMB/J07M039.00	54.09011.261
	16	TOUCH PAD BOARD/ SYNAPTICS	TOUCHPAD MULTI-SWITCH SYNAPTIC	56.1740C.001

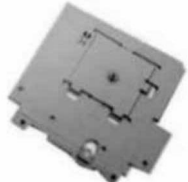
Picture	No.	Part Name	Description	Part No.
	NS	HDD BOARD	PCB 98409-1 HDD BOARD 4L TM330	48.40C03.011
	NS	TM340 MAINBOARD PIII 500	340 PIII500 MAINBOARD	55.40F01.D02
	15	TM340 MAINBOARD PIII 450	340 PIII-450 MAINBOARD	55.40F01.D01
Keyboard				
	NS	KEYBOARD/US VERSION/ Darfon	KB US NSK-85N11 340	90.40F07.031
	29	KEYBOARD/US VERSION/ JME	KB (US) JME/K9811 TM340	90.40F07.001
Power				
	NS	ADAPTER 60W/ DELTA	ADT 60W ADP-60XB D 3P 730/340	25.10064.041
	18	BATTERY PACK LI-ON/ PANASONIC	ASSY BTY PACK CGP-E/618AE 330	60.40C07.001
	NS	POWER CORD	CORD 125V UL 3P K01081B1183WP	27.01618.051

Picture	No.	Part Name	Description	Part No.
External Module				
	NS	24X CD-ROM&FDD MODULE TEAC	CD ROM/FDD MODUL TEAC/ DF240500	90.40C28.001
	NS	2X DVD-ROM&FDD MODULE TEAC	DVD/FDD MODULE TEAC/DF220500	90.40C28.002
Mechanical Parts				
	NS	LOWER CASE	ASSY L CASE 330	60.40C02.002
	20	UPPER CASE	ASSY U-CASE PC+10%CF TM340	60.40F01.001
	NS	UPPER DIMM COVER	PLT L DIMM METAL TM330	34.40C18.002
	NS	LOWER DIMM COVER	ASSY DIMM-CVR	60.40C09.001
	NS	MIDDLE COVER & SPEAKER ASSY	ASSY MIDDLE CVR TM330	60.40C08.003
	NS	LCD PANEL COAT	ASSY PNL COAT TM340	60.40F10.001
	NS	PCMCIA SOCKET	SKT PCMCIA 68P WZ2131-G2 SMD	62.10024.061
	NS	CPU HEATSINK TM340	ASSY CPU HEAT SINK TM340	60.40F05.001
	NS	CPU HOLDER TM340	ASSY CPU HOLDER TM340	60.40F03.001

Picture	No.	Part Name	Description	Part No.
	3	MODEM HEAT PLATE	PLT HEAT AL TM330	34.40C11.003
	2	TOUCH PAD BRACKET	HLD TOUCH-PAD METAL TM330	34.40C07.001
	NS	HINGE CAP PACK	ASSY HINGE CAP PACK TM330	6K.40C01.002
Cable				
	12	TOUCH PAD FPC CABLE	C.A FPC TOUCH PAD 340	50.40F04.001
	11	NETWORK CABLE	W.A 2P/2P 80MM TM340	50.40F03.001
Digital Camera				
	NS	USB DIGITAL CAMERA KIT	USB VIDEO CAPTURE KIT (V6+)	81.16848.503
Screws				
	25	SCREWS	SCRW KAM MS+SBZ M2*L9 BLACK	86.9A322.9R0
	26	SCREWS	SCRW WH MS+CBZ M2.5*L6 BLACK	86.9A323.6R0
	27	SCREWS	SCRW WAFER NYLO M2.5*6L B-ZN	86.9A353.6R0
	NS	SCREWS	SCRW WH MS+CBZ M2.5*L4 BLACK	86.9A323.4R0
	24	SCREWS	SCRW WCH FLT M2*L4 B-ZN	86.9A322.4R0
	28	SCREWS	SCRW KAH MS+CN M2*L6 NI	86.9A522.6R0
Miscellaneous				
	5	340 LOGO	PLT LOGO (TOOLING) PMMA TM330	40.40C01.001
	NS	LCD RUBBER TM330	CSN LCD RUBBER 330	47.40C01.001
	NS	FOOT RUBBER TM330	FOOT RUBBER RUBBER BT	42.43B29.001

Picture	No.	Part Name	Description	Part No.
	10	CAMERA RUBBER TM340	RUBBER CAMERA TM340	47.40F07.001
	NS	LCD LATCH TM330	LATCH LCD NYLON 050 330	42.40C06.003
	NS	LCD SPRING CATCH TM330	SPRING CATCH STEEL TM330	34.40C13.001
Others				
	NS	RTC BATTERY	IC RTC BQ3285LD SSOP 24P	71.03285.B01

Model Number and Configurations

This appendix provides the BASIC model number and the configuration to TravelMate 340 decided for Acer's "global" product offering. Contact your regional offices or the responsible personnel/channel to provide you with further extension model numbers and configurations.

- Trade Mark: Acer
- Brand Name: Acer
- Product Name: TravelMate 340
- Description: Notebook Personal Computer

Model Number Definitions

Model No.	LCD	CPU	Memory	HDD	Ext. Module	BTY
340T	12.1" TFT	Pentium III 450 (BGA on board)	64MB	6.4GB	FDD/24X CD-ROM	Li-Ion
341T	12.1" TFT	Pentium III 500 (BGA on board)	64 MB	10GB	FDD/24X CD-ROM	Li-Ion
342T	12.1" TFT	Pentium III 550 (BGA on board)	64MB	10GB	FDD/24X CD-ROM	Li-Ion

Test Compatible Components

This computer's compatibility is tested and verified by Acer's internal testing department. All of its system functions are tested under Windows 98 environment.

Refer to the following lists for components, adapter cards, and peripherals which have passed these tests. Regarding configuration, combination and test procedures, please refer to the TravelMate 340 Compatibility Test Report released by the Acer Mobile System Testing Department.

Windows 95 Environment Test

Item	Specifications
Processor	Intel Pentium III 450 Intel Pentium III 500
Hard Disk Drive	IBM 6 GB IBM 9 GB
Floppy Disk Drive	TEAC 3.5" FDD (support 3 mode)
CD-ROM Drive	TEAC 24X CD-ROM Drive
DVD-ROM Drive	TEAC 2X DVD-ROM
Memory	64 MB SDRAM 96 MB SDRAM 128 MB SDRAM 192 MB SDRAM
Power	Panasonic Li-Ion battery / 3 hours life Delta 45 Watts adapter
I/O Adapter	
Display	IBM G42 IBM 9514-B04 TFT monitor AcerView 76i AcerView 98i Color monitor V70 20" color Monitor Torisan 12.1" TFT LCD
PCMCIA - SCSI	Adaptec SlimSCSI APA-1480AB
PCMCIA - CDROM	Panasonic 20X Portable CD-ROM Player
PCMCIA - ATA	SunDisk ATA 15MB
Network Adapter	
LAN Ethernet/10baseT/100baseT	3Com EtherLink III 3Com 10/100 16bits Fast EtherLink Accton Ethernet D-Link Ethernet Xircom CreditCard Ethernet Adapter Xircom CreditCard Ethernet Adapter IIps Xircom CreditCard Ethernet Adapter 10/100 IBM EtherJet PC Card
LAN Token Ring	3Com TokenLink III 16/4 IBM Turbo 16/4 TokenRing PC Card
Multi-Function Card	3Com Ethernet III LAN + 33.6 Modem Global PC Card Combo 3Com 10/100 Fast EtherLink LAN + 56K Dlink Winconnect 33.6 LAN/Fax Modem Combo Megahertz PC Card 33.6 Ethernet-Modem with XJACK Xircom CreditCard Ethernet + Modem 33.6
CardBus	3Com Fast EtherLink XL CardBus 3Com 10/100 LAN CardBus Intel EtherExpress PRO/100 Mobile Adapter TDK Cardbus Ethernet 10/100 Base TX D-Link Fast Ethernet CardBus 10/100 mbps IBM 10/100 EtherJet CardBus Adapter (32-bit) Xircom RealPort CardBus Ethernet 10/100 Xircom CardBus Ethernet II 10/100 Xircom CardBus Ethernet 10/100 Intel Built-in LAN
Modem Adapter	
Modem (up to 28.8K)	TDK V34 28.8/14.4 Data/Fax PCMCIA Xircom PCMCIA Fax/Modem 28.8m

Item	Specifications
Modem (up to 33.6K)	Dlink Winconnect 33.6 Fax Modem Hayes Optima 336 V34 + Fax for PCMCIA W/EZjack PCMCIA Data/Fax Modem International 33.6/14.4
Modem (up to 56K)	ActionTec DataLink 56Kbps Fax/Modem TDK K56Kflex Data/Fax Modem USR Megahertz 56K Modem IBM 56K Double Jack Modem

Windows 98 Environment Test

Item	Specifications
Processor	Intel Pentium III 450 Intel Pentium III 500
Hard Disk Drive	IBM 6 GB IBM 9 GB
Floppy Disk Drive	TEAC 3.5" FDD (support 3 mode)
CD-ROM Drive	TEAC 24X CD-ROM Drive
DVD-ROM Drive	TEAC 2X DVD-ROM
Memory	64 MB SDRAM 96 MB SDRAM 128 MB SDRAM 192 MB SDRAM
Power	Panasonic Li-Ion battery / 3 hours life Delta 45 Watts adapter
I/O Adapter	
Display	IBM G42 IBM 9514-B04 TFT monitor AcerView 76i AcerView 98i Color monitor V70 20" color Monitor Flex Scan E35F Torisan 12.1" TFT LCD
PCMCIA - CDRom	Panasonic 20X Portable CD-ROM Player IBM Portable 20X CD-ROM Drive w/ sound (JP)
PCMCIA - ATA	SunDisk ATA 15MB
Network Adapter	
LAN Ethernet/10baseT/100baseT	3Com EtherLink III 3Com 10/100 16bits Fast EtherLink Accton Ethernet D-Link Ethernet Xircom CreditCard Ethernet Adapter Xircom CreditCard Ethernet Adapter IIps Xircom CreditCard Ethernet Adapter 10/100 IBM EtherJet PC Card
LAN Token Ring	3Com TokenLink III 16/4 IBM Turbo 16/4 TokenRing PC Card
Multi-Function Card	3Com Ethernet III LAN + 33.6 Modem Global PC Card Combo 3Com 10/100 Fast EtherLink LAN + 56K Dlink Winconnect 33.6 LAN/Fax Modem Combo Megahertz PC Card 33.6 Ethernet-Modem with XJACK Xircom CreditCard Ethernet 10/100 + Modem 56 Xircom CreditCard Ethernet + Modem 33.6
CardBus	3Com Fast EtherLink XL CardBus Intel EtherExpress PRO/100 Mobile Adapter TDK Cardbus Ethernet 10/100 Base TX D-Link Fast Ethernet CardBus 10/100 mbps IBM 10/100 EtherJet CardBus Adapter (32-bit) Xircom RealPort CardBus Ethernet 10/100 Xircom CardBus Ethernet II 10/100 Xircom CardBus Ethernet 10/100 Intel Built-in LAN
Modem Adapter	
Modem (up to 28.8K)	TDK V34 28.8/14.4 Data/Fax PCMCIA Xircom PCMCIA Fax/Modem 28.8m

Item	Specifications
Modem (up to 33.6K)	Dlink Winconnect 33.6 Fax Modem Hayes Optima 336 V34 + Fax for PCMCIA W/EZjack PCMCIA Data/Fax Modem International 33.6/14.4
Modem (up to 56K)	Pretec Modem 56K ActionTec DataLink 56Kbps Fax/Modem TDK K56Kflex Data/Fax Modem USR Megahertz 56K Modem IBM 56K Double Jack Modem

Windows 2000 Environment Test

Item	Specifications
Multi-Function Card Adapter	Xircom CreditCard Ethernet 10/100 + Modem 56
CardBus	3Com 10/100 LAN CardBus TDK Cardbus Ethernet 10/100 Base TX Xircom CardBus Ethernet 10/100 Built-in LAN
Network Adapters	
Ethernet/10baseT/100baseT	3Com EtherLink III 3Com 10/100 16bits Fast EtherLink D-Link Ethernet Xircom CreditCard Ethernet Adapter 10/100 IBM EtherJet PC Card
TokenRing	IBM Turbo 16/4 TokenRing PC card
Modem Adapters	
Modem (up to 28.8K)	TDK V34 28.8/14.4 Data/Fax PCMCIA Xicom PCMCIA Fax/Modem 28.8m
Modem (up to 33.6K)	Megahertz 33.6 PC Card Modem Hayes Optima 336 V34+Fax for PCMCIA W/EZjack IBM PCMCIA Data/Fax Modem International 33.6/14.4
Modem (up to 56K)	IBM 56K Double Jack Modem
I/O Adapters	
PCMCIA - SCSI	Adaptec SlimSCSI APA-1480AB
PCMCIA - CD-ROM	IBM Portable 20x Speed CD-ROM Drive w/ SOUND (JP) Panasonic 4x Portable CD-ROM Sound Player Panasonic 20x Portable CD-ROM Player

Windows NT 4.0 Environment Test

Item	Specifications
Processor	Intel Pentium III 450 MHz Intel Pentium III 500 MHz
Hard disk	IBM 9.0 GB IBM 6.0 GB
CD-ROM	TEAC 24X CD ROM Drive
DVD-ROM (optional)	TEAC 2X DVD-ROM
FDD	TEAC 3.5" FDD (supports 3-mde)
Memory	32/ 64/ 128 MB SDRAM
Power	Panasonic Li-ion battery / 3 hours life
Power Adapter	Delta 45 watts adapter
Internal Fax Modem (optional)	V.90 56K Internal Fax modem
LCD	Torisan 12.1" TFT LCD
Multi-Function Card Adapter	3COM 10/100 Fast EtherLink Lan + 56K Megahertz PC Card 33.6 Ethernet-Modem with XJACK Xircom CreditCard Ethernet 10/100 + Modem 56 Xircom CreditCard Ethernet+Modem 33.6
CardBus	3Com Fast EtherLink XL cardbus 3Com 10/100 Lan CardBus Intel EtherExpress PRO/100 Mobile Adapter TDK Cardbus Ethernet 10/100 Base TX IBM 10/100 EtherJet Cardbus Adapter(32-bit) Xircom CardBus Ethernet II 10/100 Xircom CardBus Ethernet 10/100 Intel Built-in LAN
Network Adapters	
Ethernet/10baseT/100baseT	3Com EtherLink III 3Com 10/100 16bits Fast EtherLink D-Link Ethernet Xircom CreditCard Ethernet adapter Xircom CreditCard Ethernet Adapter IIps Xircom CreditCard Ethernet Adapter 10/100 IBM EtherJet PC Card
TokenRing	3Com TokenLink III 16/4 IBM Turbo 16/4 TokenRing PC card
Modem Adapters	
Modem (up to 28.8K)	TDK V34 28.8/14.4 Data/Fax PCMCIA Xicom PCMCIA Fax/Modem 28.8m
Modem (up to 33.6K)	Dlink Winconnet 33.6 Fax modem Hayes Optima 336 V34+Fax for PCMCIA W/EZjack IBM PCMCIA Data/Fax Modem International 33.6/14.4
Modem (up to 56K)	Pretec Modem 56K ActionTec DataLink 56Kbps Fax/Modem USR Megahertz 56K modem IBM 56K Double Jack Modem

Item	Specifications
I/O Adapters	
Display	IBM G42 IBM 9514-B04 TFT monitor Acer AcerView 76i Acer AcerView 98i Compaq Color mionitor V70 NEC 20" color Monitor NANA0 Flex Scan E35F
PCMCIA - SCSI	Adaptec SlimSCSI APA-1480AB
PCMCIA - CD-ROM	IBM Portable 20x Speed CD-ROM Drive w/ SOUND (JP) Panasonic 4x Portable CD-ROM Sound Player Panasonic 20x Portable CD-ROM Player
PCMCIA - ATA	SunDisk ATA 15MB

Online Support Information

This section describes online technical support services available to help you repair your Acer Systems.

If you are a distributor, dealer, ASP or TPM, please refer your technical queries to your local Acer branch office. Acer Branch Offices and Regional Business Units may access our website. However some information sources will require a user i.d. and password. These can be obtained directly from Acer CSD Taiwan.

Acer's Website offers you convenient and valuable support resources whenever you need them.

In the Technical Information section you can download information on all of Acer's Notebook, Desktop and Server models including:

- Service guides for all models
- User's manuals
- Training materials
- Main manuals
- Bios updates
- Software utilities
- Schematics
- Spare parts lists
- Chips
- TABs (Technical Announcement Bulletin)

The service repair section provides you with downloadable information on:

- Troubleshooting guides
- Tooling box information
- Repair instructions for specific models
- Basic repair guidelines
- Debug cards for Acer's latest models

For these purposes, we have included an Acrobat File to facilitate the problem-free downloading of our technical material.

Also contained on this website are:

- Detailed information on Acer's International Traveler's Warranty (ITW)
- Returned material authorization procedures
- An overview of all the support services we offer, accompanied by a list of telephone, fax and email contacts for all your technical queries.

We are always looking for ways to optimize and improve our services, so if you have any suggestions or comments, please do not hesitate to communicate these to us.

A

AC Adapter 21
 AC adapter 6
 ACPI 1
 ACPI 1.0a 14
 Adapters 84
 CardBus 84, 85
 Display 86
 I/O 84, 86
 Modem 84, 85
 Multi-Function Card 85
 Multi-function card 84
 Network/LAN 84, 85
 Power 85
 AFLASH Utility 34
 ALI M1533 5, 14
 ALI M1621 4, 14
 Ambit 15
 APM 1
 APM 1.2 14
 Audio 1, 14, 17
 Auxiliary Input Device Check 54

B

Battery 1, 20
 Battery Pack 43
 charging indicator 11
 BIOS 5, 14
 package 14
 password control 14
 ROM size 14
 ROM type 14
 Setup Utility 25
 vendor 14
 Version 14
 BIOS setup 25
 BIOS Supports protocol 14
 BIOS Utility 25
 Basic System Settings 27
 Date, setting 27
 Load Default Settings 33
 navigating 25
 Navigating the 25
 Onboard Devices Configuration 29
 Power Management 32
 Startup Configuration 27

System Information 26
 System Security 30

Board Layout 4
 BQ3285LD 14
 brightness
 hot keys 12

C

Cache
 controller 14
 size 14
 caps lock
 on indicator 11
 CardBus 1, 19, 85
 Check Procedures 54
 Battery 55
 Diskette Drive 54
 External CD-ROM Drive 54
 Keyboard 54
 Memory 55
 Power Adapter 55
 Power System Checkout 55
 Touchpad 56
 Chipsets 14
 CMOS setup 25
 Combo Drive 1, 6
 CD-ROM/ Floppy Drive 16
 DVD-ROM/Floppy Diskette 17
 Compatibility Test 79
 Computer
 display 2
 keyboards 12
 on indicator 11
 Connectors 65
 Controllers 14
 Core logic 14
 Cover
 middle 46
 removing 46
 CPU
 core voltage 14
 I/O voltage 14
 package 14
 type 14
 CRT 2
 Cyber 9525 4

D

- Date
 - setting in Setup Utility 27
- Design 1
- Diagnostics
 - PQA 37
- DIMM 4, 5, 14
 - Combinations 15
 - external 45
 - internal 49
 - package 15
 - removing 45, 49
 - Speed 15
 - voltage 15
- Disassembly
 - Battery Pack 43
 - Hard Disk Drive 44
 - Machine 39
 - Procedure Flowchart 41
- Diskette
 - System Diagnostics 36
 - System Utility 35
- Display 2
 - computer 2
- Dual Display 2
 - hot keys 12
 - opening and closing 2
 - performance 2
 - power management 2
 - simultaneous 2
- Display Standby Mode 22
- DMA Channel Assignment 24
- DVD 1

E

- Easy Link Combo Drive 1
- Environmental Requirements 22
- Error Messages 58
- Error Symptoms 60
 - Indicator 60
 - LCD 60
 - Memory 61
 - PCMCIA 61
 - Power 60
 - Power Management 61
 - Speaker 61
- Error Symptom-to-Spare Part Index 57
- ESS ES1946 5
- Ethernet/10baseT/100baseT 1, 84, 85
- Euro 13
- External Diskette Drive Check 54

F

- Fan Utility 35
- FIR 1, 7, 8, 19
- Flash ROM 5
- Flash Utility 34
- FRU (Field Replaceable Unit) List 67
 - External Module 74
 - Keyboard 73
 - Mechanical Parts 74
 - Power 73
 - Screws 75
 - Storage Device 71

H

- Hard disk 1, 14, 16, 85, 80
 - disassembling the 44
 - removing the 44
- Hard Disk Standby Mode 22
- Hardware Configuration and Specification 14
- HDD 1, 14, 16
- Hibernation Mode 22
- Hibernation mode
- hot key 12
- Hotkeys. See Heuristic Power Management
- Humidity 22

I

- I/O Address Map 23
- I/O Adapter
 - Display 82
 - PCMCIA - ATA 80
 - PCMCIA - CDROM 80
 - PCMCIA - SCSI 80
- Indicators 11
- Infrared
 - setting in BIOS Utility 29
 - Intermittent Problems 63
- IrDA 19
- IRQ Assignment Map 24

J

- Jumpers 65
 - Bottom View 66
 - Top View 65

K

- KB 9525 14
- Keyboard 14, 20
 - removing the 49

hot keys 12
Special Keys 12
Keyboard Device Check 54

L

L2 cache 14
L2 cahe 14
LAN 1, 7
LAN/Modem Combo 15
LCD 1, 2, 20
 DC-AC LCD Inverter 20
 disassembling the 46
 removing 46
Li-Ion 1
Load Default Settings 33
Lower Case
 removing 50

M

M38867 5, 14
M5229 14
Machine Disassembly 39
Main Board
 removing the 51
Main Board Data Utility 35
Main Unit
 disassembling the 49
Mechanical Specification 22
media access
 on indicator 11
Memory 1, 80
 Address Map 23
Memory Address Map 23
Memory Check 55
Model Number and Configurations 77
Model Number Definitions 77
Modem 1, 7, 15, 84, 85
 removing 49
Modem Adapter 80

N

Network 1, 7
Network Adapter
 Ethernet/10baseT/100baseT 80
 Token Ring 80
NS PC97338 5
NS PC97338VJG 14
num lock

on indicator 11

O

Onboard Devices Configuration 29
Online Support Information 81
OZ6812 5

P

Panel 6
 left 6
 rear 6
 right 8
Panel ID Utility 35
Parallel Port 7, 18
Parallel port
 setting in BIOS Utility 29
Password
 Changing a 32
 removing a 31
 Setting a 30
PC Card 8, 9, 14, 19
PC Card, PCMCIA 1
PCB 99203 65
PCMCIA 4, 19, 84
 ATA 86
 CD-ROM 86
 SCSI 86
Pentium III 14
Pentium® III 1
Ports
 FIR 4
 Line-in/ Line-out 4
 Mic-in 4
 Parallel/ Serial 4
 PS/2 4
 Speaker 4
 USB 4
 Video 4
POST 57
Power 80
 managing in BIOS Utility 32
Power Management 2, 22, 32
Power System Check 55
 Battery Pack 55
 Power Adapter 55
Power System Checkout 55
PQA
 diagnostics 37
PQA Diagnostics Program 37
Processor 14, 80, 85
PS/2 7

R

RTC 4, 14
removing 50

S

Screw List 42
Second Level Cache 14
Serial Port 7, 19
Serial port
setting in BIOS Utility 29
Solo-1E 5
Speaker 1
removing 46
hot key 12
Standby Mode 22
Standby mode
hot key 12
status indicator 11
Startup Configuration 27
Super I/O 14
SVGA 2
System
Basic Settings 27
Block Diagram 3
Diagnostic Diskette 36
Layout 4
Utilities 25
Utility Diskette 35
System Check Procedures 54
System Information 26
System Memory 14
System Security 30

T

Temperature 22
TokenRing 84, 85

Test Compatible Components 79
TFT SVGA 1
Thermal Utility 35
TIME
setting in Setup Utility 27

Touchpad
removing 52
touchpad
hot key 12
Touchpad Check 56
Troubleshooting 53

U

Undetermined Problems 63
USB 1, 6, 7, 19
Utilities 25

W

Windows 2000 Environment Test 82
Windows 95 Environment Test 80
Windows 98 Environment Test 81
Windows NT 4.0 Environment Test 83

V

Vibration 22
Video 1, 2, 18
Resolutions 18
Video Port 7
volume
hot keys 12

Z

Zoomed Video 1
ZV 1