

Acer TravelMate 430 Series

Service Guide

Service guide files and updates are available on the ACER/CSD web; for more information, please refer to <http://csd.acer.com.tw>

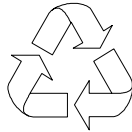

100% Recycled Paper

PART NO.: VD.T26V5.001

PRINTED IN TAIWAN

Revision History

Please refer to the table below for the updates made on TravelMate 430 service guide.

Date	Chapter	Updates

Copyright

Copyright © 2003 by Acer Incorporated. All rights reserved. No part of this publication may be reproduced, transmitted, transcribed, stored in a retrieval system, or translated into any language or computer language, in any form or by any means, electronic, mechanical, magnetic, optical, chemical, manual or otherwise, without the prior written permission of Acer Incorporated.

Disclaimer

The information in this guide is subject to change without notice.

Acer Incorporated makes no representations or warranties, either expressed or implied, with respect to the contents hereof and specifically disclaims any warranties of merchantability or fitness for any particular purpose. Any Acer Incorporated software described in this manual is sold or licensed "as is". Should the programs prove defective following their purchase, the buyer (and not Acer Incorporated, its distributor, or its dealer) assumes the entire cost of all necessary servicing, repair, and any incidental or consequential damages resulting from any defect in the software.

Acer is a registered trademark of Acer Corporation.

Intel is a registered trademark of Intel Corporation.

Pentium and Pentium II/III are trademarks of Intel Corporation.

Other brand and product names are trademarks and/or registered trademarks of their respective holders.

Conventions

The following conventions are used in this manual:

SCREEN MESSAGES	Denotes actual messages that appear on screen.
NOTE	Gives bits and pieces of additional information related to the current topic.
WARNING	Alerts you to any damage that might result from doing or not doing specific actions.
CAUTION	Gives precautionary measures to avoid possible hardware or software problems.
IMPORTANT	Reminds you to do specific actions relevant to the accomplishment of procedures.

Preface

Before using this information and the product it supports, please read the following general information.

1. This Service Guide provides you with all technical information relating to the BASIC CONFIGURATION decided for Acer's "global" product offering. To better fit local market requirements and enhance product competitiveness, your regional office MAY have decided to extend the functionality of a machine (e.g. add-on card, modem, or extra memory capability). These LOCALIZED FEATURES will NOT be covered in this generic service guide. In such cases, please contact your regional offices or the responsible personnel/channel to provide you with further technical details.
2. Please note WHEN ORDERING FRU PARTS, that you should check the most up-to-date information available on your regional web or channel. If, for whatever reason, a part number change is made, it will not be noted in the printed Service Guide. For ACER-AUTHORIZED SERVICE PROVIDERS, your Acer office may have a DIFFERENT part number code to those given in the FRU list of this printed Service Guide. You MUST use the list provided by your regional Acer office to order FRU parts for repair and service of customer machines.

Chapter 1	System Specifications	1
	Features	1
	System Block Diagram	3
	Board Layout	4
	Top View	4
	Bottom View	5
	Outlook View	6
	Front View	6
	Left Panel	8
	Right Panel	9
	Rear Panel	10
	Bottom Panel	11
	Indicators	12
	Lock Keys	13
	Embedded Numeric Keypad	14
	Windows Keys	15
	Hot Keys	16
	The Euro Symbol	18
	Launch Keys	19
	E-Mail Detection	20
	Touchpad	21
	Touchpad Basics	21
	Hardware Specifications and Configurations	23
Chapter 2	System Utilities	37
	BIOS Setup Utility	37
	Navigating the BIOS Utility	37
	Info.	39
	Main	41
	Advanced	43
	Security	44
	Boot	48
	Exit	49
	BIOS Flash Utility	50
	System Diagnostic Diskette	50
	Running Diagnostics Program	52
Chapter 3	Machine Disassembly and Replacement	59
	General Information	60
	Before You Begin	60
	Disassembly Procedure Flowchart	61
	Removing the Optical Module/HDD Module and Memory	64
	Removing the Optical Module	64
	Removing the HDD module	64
	Removing the Memory	64
	Removing the Keyboard/ LCD Module and VGA Board	65
	Removing the Keyboard	65
	Removing the LCD module and VGA Board	65
	Disassembling the Main Unit	67
	Disassembling the LCD Module	72
	Disassembling the External Modules	73
	Disassembling the HDD Module	73
	Disassembling the Optical Disk Drive Module/Combo Drive Module	73

Table of Contents

Chapter 4	Troubleshooting	75
	System Check Procedures	76
	External Diskette Drive Check	76
	External CD-ROM/DVD-ROM Drive Check	76
	Keyboard or Auxiliary Input Device Check	77
	Memory Check	77
	Power System Check	77
	Touchpad Check	79
	Display Check	79
	Sound Check	80
	Power-On Self-Test (POST) Error Message	81
	Index of Error Messages	82
	Index of Symptom-to-FRU Error Message	84
	Intermittent Problems	87
	Undetermined Problems	88
	POST Task Routines	89
	Index of Flash BIOS Error Message	93
Chapter 5	Jumper and Connector Locations	95
	Top View	95
	SW1 Settings (Lid switch)	96
	SW2 Settings	96
	Bottom View	97
Chapter 6	FRU (Field Replaceable Unit) List	99
Appendix A	Model Definition and Configuration	118
	TravelMate 420 Series	118
	Main Features	119
Appendix B	Test Compatible Components	121
	Microsoft® Windows® XP Home Environment Test	122
	Microsoft® Windows® XP Pro Environment Test	125
	Microsoft® Windows® 2000 Environment Test	127
Appendix C	Online Support Information	129
Index		131

System Specifications

Features

This computer was designed with the user in mind. Here are just a few of its many features:

Performance

- Intel® Desktop P4P CPU with packing mPGA 478 package
- PC2100 DDR SDRAM, Maximum memory up to 2GB (with two 1024MB SODIMM when available)
- Internal optical drive (swappable with optional drive)
- Removable PCI Bus Master Enhanced IDE hard disk
- Li-Ion main battery pack
- Power management system with ACPI (Advanced Configuration Power Interface)

Display

- Thin-Film Transistor (TFT) liquid-crystal display (LCD) displaying 32-bit high true colour up to 16.7 million colours at 1024X768 eXtended Graphics Array (XGA) resolution for 14.1"/15.0" or 1400x1050 Super eXtended Graphics Array+ (SXGA+) for resolution for some 15.0" models (specification varies depending on models)
- 3D capabilities
- Simultaneous LCD and CRT display support
- S-video for output to a television or display device that supports S-video input
- "Automatic LCD dim" feature that automatically decides the best settings for your display and conserves power
- Dual display capability

Multimedia

- Realtek ALC202 AC'97 Codec audio
- Built-in dual speakers
- Built-in microphone
- High-speed optical drive
- Direct CD Player

Connectivity

- High-speed fax/data modem port
- Ethernet/Fast Ethernet port
- 3 USB 2.0 (Universal Serial Bus) ports
- IEEE 1394 port
- SD/MMC memory slot
- Memory stick slot
- Acer EasyPort port replicator
- Wireless LAN ready (specification varies depending on models)
- Bluetooth ready (specification varies depending on models)

Human-centric design and ergonomics

- 4-way scroll button
- Sleek, smooth and stylish design
- Acer FinTouch full-sized curved keyboard
- Ergonomically-centered touchpad pointing device

Expansion

- One type II CardBus PC Card slots
- Upgradeable memory

Keyboard and Pointing Device

- Acer FineTouch keyboard: with 5° curve
- 84/85/88-key windows keyboard, inverted “T” cursor layout, 18mm spacing, 2.5mm (min) key travel
- Built-in touchpad with ergonomic buttons and 4-way integrated scroll key
- 12 function keys; 4 cursor keys; two Windows keys; hotkey controls; 4 launch keys, including Internet browser, email (with LED for received mail), and 2 user-programmable keys
- Embedded numeric keypad
- International language support

I/O Ports

- One type II CardBus slots
- One RJ-11 modem jack
- One RJ-45 network jack
- One DC-in jack for AC adapter
- One ECP/EPP-compliant parallel port
- One external monitor port
- One headphone/speaker/line-out jack (3.5mm mini jack)
- One microphone/line-in jack (3.5mm mini jack)
- One S-video-out (NTSC/PAL) port
- Three Universal Serial Bus (USB) ports
- One IEEE 1394 port
- 100-pin port replicator connector for Acer EasyPort
- One SD/MMC slots
- One memory stick slot

System Block Diagram

File Name : LA-1761

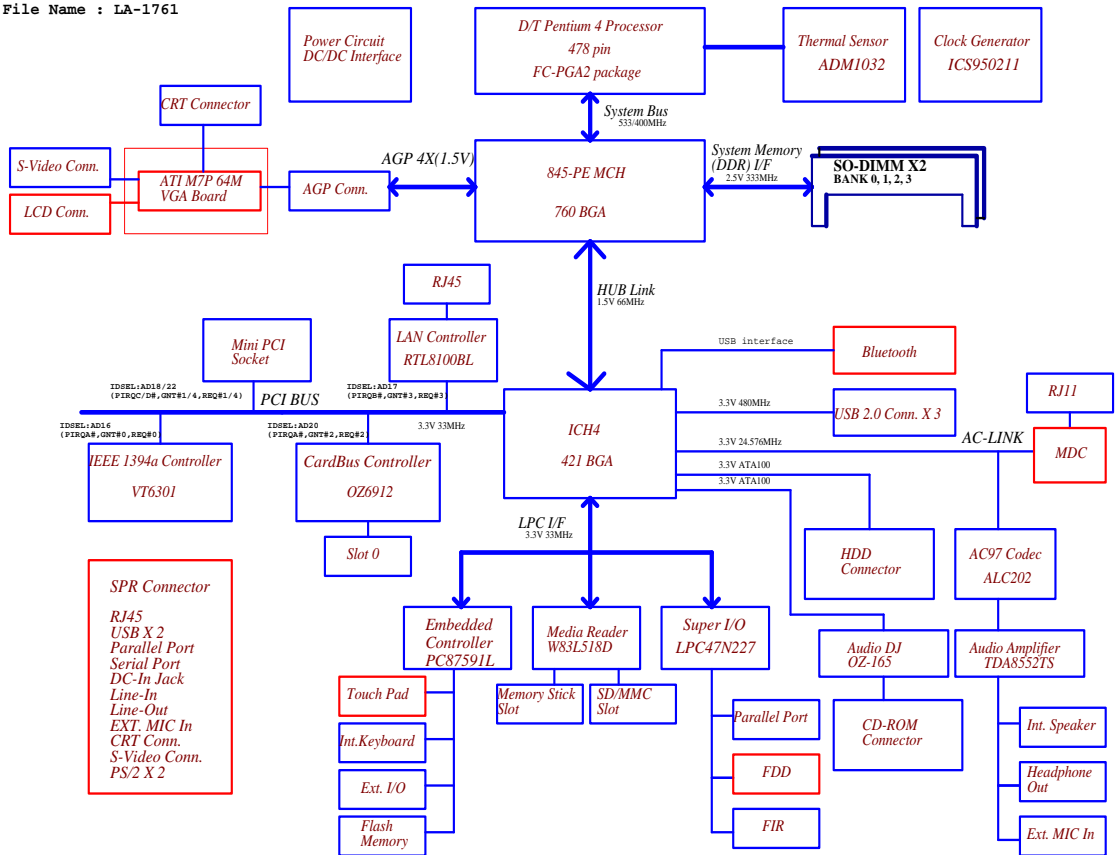

Board Layout

Top View

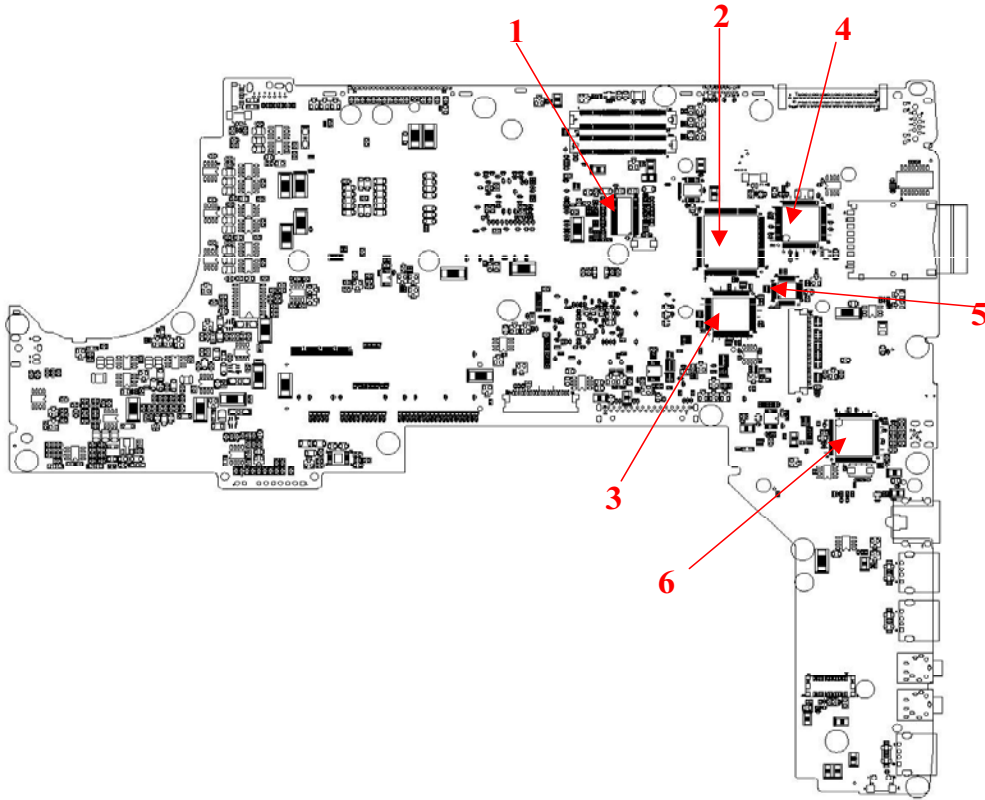

1-U5	Clock Generator	4-U6	LAN Controller
2-U9	CardBus Controller	5-U11	Media Reader
3-U16	Super I/O	6-U23	IEEE 1394a Controller

Bottom View

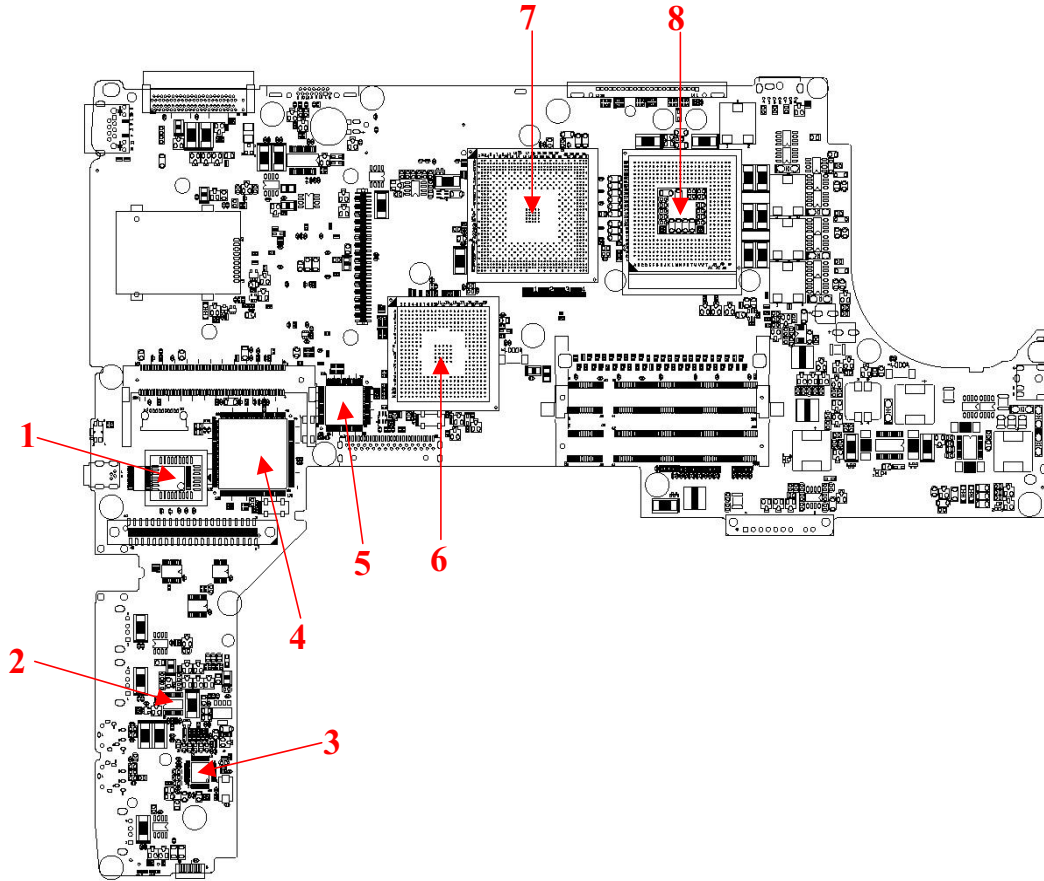

1-U41	Flash Memory	5-U37	Audio DJ
2-U52	Audio Amplifier	6-U35	Southbridge
3-U54	Audio CODEC	7-U31	Northbridge
4-U42	Embedded Controller	8-U32	CPU

Outlook View

A general introduction of ports allow you to connect peripheral devices, as you would with a desktop PC.

Front View

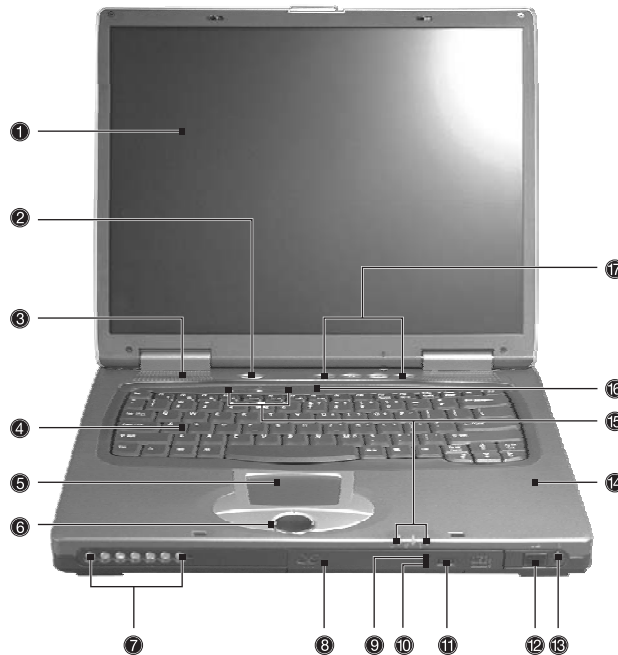



#	Icon	Item	Description
1		Display screen	Also called LCD (liquid-crystal display), displays computer output.
2		Power Button	Turns on the computer power.
3		Speakers	Outputs sound.
4		Keyboard	Inputs data into your computer
5		Touchpad	Touch-sensitive pointing device which functions like a computer mouse.
6		Click buttons (left, center and right)	The left and right buttons function like the left and right mouse buttons; the center button serves as a 4-way scroll button.
7		Audio DJ controls	Button and indicators for the Audio DJ function.
8		Optical drive	Houses an optical drive module (CD-ROM, DVD-ROM or DVD/CD-RW combo drive).
9		Optical drive indicator	Lights up when the optical drive is active.
10		Emergency eject slot	Ejects the drive tray when the computer is turned off.
11		Eject button	Eject the drive tray.
12		Infrared port	Interfaces with infrared devices (e.g., infrared PDA, IR-aware computer).
13		Wireless networking/Bluetooth button	Enables or disables the wireless networking/ Bluetooth feature.

14		Palmrest	Comfortable support area for your hands when you use the computer. Outputs sound.
15		Status indicators	LEDs (light-emitting diode) that turn on and off to show the status of the computer, its functions and components.
16		Microphone	Inputs sounds and voice into your computer.
17		Launch keys	Special keys for launching Internet browser, E-mail program and frequently used programs. Located at the top of the keyboard are five buttons. They are designated as P1, P2, E-mail button and Web browser button. P1 and P2 launch user-programmable applications; E-mail and Web browser launch E-mail and Internet browser applications.

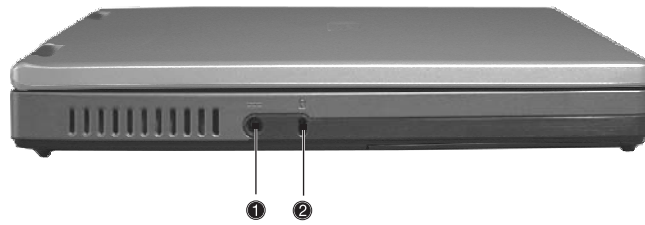





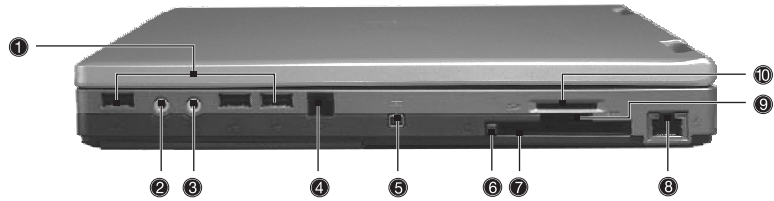

Left Panel



#	Icon	Item	Description
1		Power jack	Connects to an AC adapter.
2		Security keylock	Connects to a Kensington-compatible computer security lock.





Right Panel

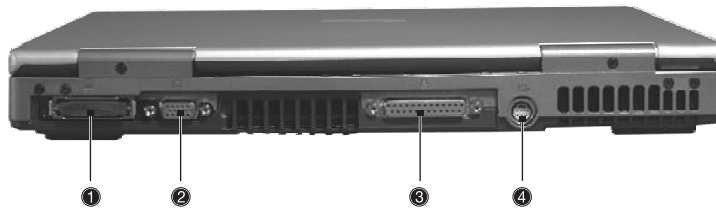

#	Icon	Item	Description
1		USB port	Connects to Universal Serial Bus devices (e.g., USB mouse, USB camera).
2		Line-in/Mic-in jack	Accepts audio line-in devices (e.g., audio CD player, stereo walkman). Selection is through the OS Windows mixer.
3		Speaker/Headphone-out jack	Connects to audio line-out devices (e.g., speakers, headphones)
4		Modem jack	Connects to a phone line
5		IEEE 1394 port	Connects to an IEEE 1394 device.
6		PC card eject buttons	Eject the PC Card from the slot.
7		PC card slots	Accepts all Type II PC cards.
8		Network jack	Connects to an Ethernet 10/100-based network.
9		Memory stick slot	Accepts memory sticks.
10		SD/MMC slot	Accepts SD or MMC cards.

Rear Panel



#	Icon	Item	Description
1		Expansion port	I/O replicator or EasyPort expansion devices.
2		External display port	Connects to a display device (e.g., external monitor, LCD projector).
3		Parallel port	Connects to a parallel device (e.g., parallel printer).
4		S-video	Connects to a television or display device with S-video input.

Bottom Panel

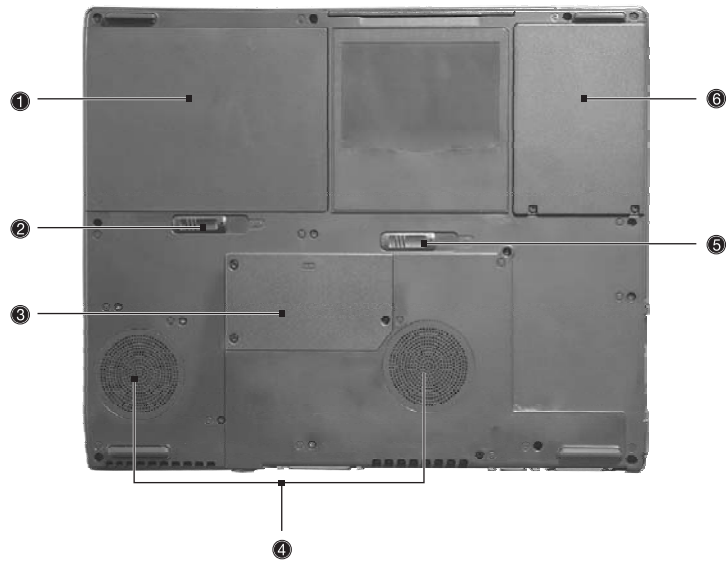







#	Icon	Item	Description
1		Battery bay	Houses the computer's battery pack.
2		Battery release latches	Unlatches the battery to remove the battery pack.
3		Memory compartment	Houses the computer's main memory.
4		Cooling fan	Helps keep the computer cool. Note: Don't cover or obstruct the opening of the fan.
5		AcerMedia drive bay release latch	latches the AcerMedia bay to remove the optical diskette drive.
6		Hard disk bay	Houses the computer's hard disk.

Indicators

The computer has seven easy-to-read status icons below the display screen.





The status LCD displays icons that show the status of the computer and its components.

Icon	Function	Description
	Power	Lights green when the computer is on. Flashes when the computer is in low power.
	Sleep	Flashes when the computer enters Sleep mode. Lights when the computer is in Sleep mode.
	Battery charge	Lights green when the battery is being charged.
	Wireless communication	Lights when the Wireless LAN or Bluetooth capabilities are enabled.
	Caps lock	Lights when Caps Lock is activated.
	Num lock	Lights when Num Lock is activated.
	Media activity	Lights when the hard disk or AcerMedia drive is active.

Lock Keys

The keyboard has three lock keys which you can toggle on and off.



Lock Key	Description
Caps Lock	When Caps Lock is on, all alphabetic characters typed are in uppercase.
Num lock (Fn-F11)	When Num Lock is on, the embedded keypad is in numeric mode. The keys function as a calculator (complete with the arithmetic operators +, -, *, and /). Use this mode when you need to do a lot of numeric data entry. A better solution would be to connect an external keypad.
Scroll lock (Fn-F12)	When Scroll Lock is on, the screen moves one line up or down when you press  and  respectively. Scroll Lock does not work with some applications.

Embedded Numeric Keypad

The embedded numeric keypad functions like a desktop numeric keypad. It is indicated by small characters located on the upper right corner of the keycaps. To simplify the keyboard legend, cursor-control key symbols are not printed on the keys.











Desired Access	Num Lock On	Num Lock Off
Number keys on embedded keypad	Type numbers in a normal manner.	
Cursor-control keys on embedded keypad	Hold SHIFT while using cursor-control keys.	Hold Fn while using cursor-control keys.
Main keyboard keys	Hold Fn while typing letters on embedded keypad.	Type the letters in a normal manner.

Windows Keys

The keyboard has two keys that perform Windows-specific functions.



Key	Icon	Description
Windows logo key 		Start button. Combinations with this key perform special functions. Below are a few examples:  + Tab (Activates next taskbar button)  + E (Explores My Computer)  + F (Finds Document)  + M (Minimizes All)  +  + M (Undoes Minimize All)  + R (Displays the Run... dialog box)
Application key 		Opens a context menu (same as a right-click).







Hot Keys

The computer uses hotkey or key combinations to access most of the computer's controls like screen brightness, volume output.

To activate hot keys, press and hold the **Fn** key before pressing the other key in the hot key combination.



Hot Key	Icon	Function	Description
Fn-F1	?	Hot key help	Displays help on hot keys.
Fn-F2		System Property	Displays the System Property.
Fn-F3		Power Options	Display the Power Options Properties used by the computer (function available if supported by operating system).
Fn-F4	Zz	Sleep	Puts the computer in Sleep mode.
Fn-F5		Display toggle	Switches display output between the display screen, external monitor (if connected) and both the display screen and external monitor.
Fn-F6		Screen blank	Turns the display screen backlight off to save power. Press any key to return.
Fn-F7		Touchpad toggle	Turns the internal touchpad on and off.
Fn-F8		Speaker toggle	Turns the speakers on and off.
Fn-		Volume up	Increases the speaker volume.

Hot Key	Icon	Function	Description
Fn- 		Volume down	Decreases the speaker volume.
Fn- 		Brightness up	Increases the screen brightness.
Fn- 		Brightness down	Decreases the screen brightness

The Euro Symbol

If your keyboard layout is set to United States-International or United Kingdom or if you have a keyboard with a European layout, you can type the Euro symbol on your keyboard.



NOTE: For US keyboard users: The keyboard layout is set when you first set up Windows. For the Euro symbol to work, the keyboard layout has to be set to United States-International.

To verify the keyboard type in Windows 2000, follow the steps below:

1. Click on **Start, Settings, Control Panel**.
2. Double-click on **Keyboard**.
3. Click on the **Language** tab.
4. Verify that keyboard layout used for "En English (United States)" is set to United States-International. If not, select and click on **Properties**; then select **United States-International** and click on **OK**.
5. Click on **OK**.

To verify the keyboard type in Windows XP, follow the steps below:

1. Click on **Start, Control Panel**.
2. Double-click on **Regional and Language Options**.
3. Click on the **Language** tab and click on **Details**.
4. Verify that the keyboard layout used for "En English (United States)" is set to United States-International. If not, select and click on **ADD**; then select **United States-International** and click on **OK**.
5. Click on **OK**.

To type the Euro symbol:

1. Locate the Euro symbol on your keyboard.
2. Open a text editor or word processor.
3. Hold **Alt Gr** and press the Euro symbol.

NOTE: Some fonts and software do not support the Euro symbol. Please refer to www.microsoft.com/typography/faq/faq12.htm for more information.

Launch Keys

Located at the top of keyboard are five buttons. These buttons are called launch keys. They are designated as P1, P2, Email button and Web browser button.



NOTE: To the left of these five launch keys is the wireless communication button. This wireless communication button works for model with 802.11b wireless LAN only.

Launch Key	Default application
P1	User-programmable
P2	User-programmable
Email	Email application
Web browser	Internet browser application

E-Mail Detection

Click right button at the Launch Manager icon on the taskbar and click on E-Mail Detection. In this dialog box, you have the option to enable/disable mail checking, set the time interval for mail checking, etc. If you already have an email account, you can fill in User Name, Password and POP3 Server in the dialog box. The POP3 Server is the mail server where you get your email.

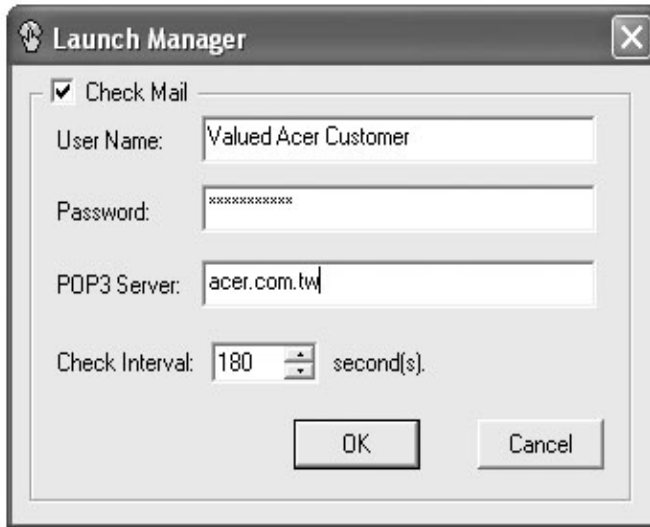

Aside from the email checking function, there is a mail button that is used to launch the email application. It is located above the keyboard right below the LCD.

Touchpad

The built-in touchpad is a pointing device that senses movement on its surface. This means the cursor responds as you move your finger on the surface of the touchpad. The central location on the palmrest provides optimal comfort and support.



NOTE: If you are using an external USB mouse, you can press **Fn-F7** to disable the touchpad.

Touchpad Basics

The following teaches you how to use the touchpad:



- Move your finger across the touchpad to move the cursor.
- Press the left (1) and right (3) buttons located on the edge of the touchpad to do selection and execution functions. These two buttons are similar to the left and right buttons on a mouse. Tapping on the touchpad produces similar results.
- Use the 4-way scroll (2) button (top/bottom/left/and right) to scroll a page up, down, left or right. This button mimics your cursor pressing on the vertical and horizontal scroll bars of Windows applications.

Function	Left Button	Right Button	Scroll Button	Tap
Execute	Click twice quickly			Tap twice (at the same speed as double-clicking the mouse button)
Select	Click once			Tap once
Drag	Click and hold, then use finger to drag the cursor on the touchpad			Tap twice (at the same speed as double-clicking a mouse button) then hold finger to the touchpad on the second tap to drag the cursor

Function	Left Button	Right Button	Scroll Button	Tap
Access context menu		Click once		
Scroll			Click and hold the button in the desired direction (up/down/left/right)	

NOTE: Keep your fingers dry and clean when using the touchpad. Also keep the touchpad dry and clean. The touchpad is sensitive to finger movements. Hence, the lighter the touch, the better the response. Tapping harder will not increase the touchpad's responsiveness.

Hardware Specifications and Configurations

Processor

Item	Specification
CPU type	Intel desktop Pentium 4 processor at 2.26GHz~3.06GHz or higher
CPU package	mPGA478 package
CPU core voltage	Depend on CPU VID
CPU I/O voltage	1.2V

BIOS

Item	Specification
BIOS vendor	Phoenix
BIOS Version	PhoenixBIOS 4.0 Release 6.0
BIOS ROM type	Flash ROM
BIOS ROM size	512KB
BIOS package	TSOP
Supported protocols	ACPI 1.0b, PC Card 95, SM BIOS 2.3, EPP/IEEE 1284, ECP/IEEE 1284 1.7 & 1.9, PCI 2.2, PnP 1.0a, DMI 2.0, PS/2 keyboard and mouse, USB, VGA BIOS, CD-ROM bootable,
BIOS password control	Set by setup manual

Second Level Cache

Item	Specification
Cache controller	Built-in CPU
Cache size	512KB
1st level cache control	Always enabled
2nd level cache control	Always enabled
Cache scheme control	Fixed in write-through

System Memory

Item	Specification
Memory controller	
Memory size	256/512MB
DIMM socket number	2 sockets
Supports memory size per socket	1024MB
Supports maximum memory size	2G (by two 1024MB SO-DIMM module)
Supports DIMM type	DDR Synchronous DRAM
Supports DIMM Speed	133 MHz
Supports DIMM voltage	2.5V/1.25V
Supports DIMM package	200-pin soDIMM
Memory module combinations	You can install memory modules in any combinations as long as they match the above specifications.

Memory Combinations

Slot 1	Slot 2	Total Memory
256/512MB	0 MB	256MB/512MB
256/512MB	128MB	384MB/640MB
256/512MB	256MB	512MB/768MB
256/512MB	512MB	768MB/1024MB

NOTE: Above table lists some system memory configurations. You may combine DIMMs with various capacities to form other combinations. .

LAN Interface

Item	Specification
Supports LAN protocol	10/100 Mbps
LAN connector type	RJ45
LAN connector location	Right side

Modem Interface

Item	Specification
Data modem data baud rate (bps)	56K
Supports modem protocol	V.90 MDC or Billionton
Modem connector type	RJ11
Modem connector location	Right side

Hard Disk Drive Interface

Item	Specification						
Vendor & Model Name	IBM 20G	IBM 30G	IBM 40G	Toshiba 40G (MK4018)	Hitachi 20G DK23DA-20F	Hitachi 30G DK23DA-30F	Hitachi 40G DK23DA-40F
Capacity (MB)	20000	30000	40000	40000	20000	30000	40000
Bytes per sector	512	512	512	512	512	512	512
Data heads	2	3	4	4	2	3	4
Drive Format							
Disks	1	2	2	2	1	2	2
Spindle speed (RPM)	4200 RPM	4200 RPM	4200 RPM	4200 RPM	4200 RPM	4200 RPM	4200 RPM
Performance Specifications							
Buffer size	2048KB	2048KB	2048KB	2048	512KB	2048KB	2048KB
Interface	ATA-5	ATA-5	ATA-5	ATA-5	ATA-5	ATA-5	ATA-5
Max. media transfer rate (disk-buffer, Mbytes/s)	130~245	125~241	130~245	156.9~290.4	149.6~277.6	149.6~277.6	149.6~277.6
Data transfer rate (host-buffer, Mbytes/s)	100 MB/Sec. Ultra DMA mode-5	100 MB/Sec. Ultra DMA mode-5	100 MB/Sec. Ultra DMA mode-5	100 MB/Sec. Ultra DMA mode-5	100 MB/Sec. Ultra DMA mode-5	100 MB/Sec. Ultra DMA mode-5	100 MB/Sec. Ultra DMA mode-5
DC Power Requirements							
Voltage tolerance	5V(DC) +/- 5%	5V(DC) +/- 5%	5V(DC) +/- 5%	5V(DC) +/- 5%	5V(DC) +/- 5%	5V(DC) +/- 5%	5V(DC) +/- 5%

DVD-ROM Interface

Item	Specification	
Vendor & model name	Toshiba (SR-C2612)	
Performance Specification	With CD Diskette	With DVD Diskette
Transfer rate (KB/sec)	(Mode1) 4X-5.7X PCAV 600-855KByte/s 10.3X-24X CAV 1552-3600KByte/s (Mode2) 4X-5.7X PACV 684.4-975.3KBytes/s 10.3X-24X CAV 1769-4104KByte/s	3.3X-8X CAV 4463-10820KByte/s
Data Buffer Capacity	192 KBytes	
Interface	IDE/ATAPI	
Applicable disc format	DVD: DVD-ROM (DVD-5, DVD-9, DVD-10, DVD-18), DVD-R (read, single border), DVD-RW(read) DVD-RAM (read, Version2.1), DVD-RAM (read, Version 1.0) CD: CD-Audio, CD+(E)G, CD-MIDI, CD-TEXT, CD-ROM, CD-ROM XA, CD-I, CD-I Bridge (Photo-CD, Video-CD) Multisession CD (Photo-CD, CD-EXTRA, CD-R, CD-RW), CD-R (read), CD-RW (read)	
Loading mechanism	Load: Manual Release: (a) Electrical Release (Release Button) (b) Release by ATAPI command (c) Emergency Release	
Power Requirement		
Input Voltage	+5 V +/- 5 % (Operating) +/- 8 % (Start up)	
Input Voltage	+5 V +/- 0.25V	

Audio Interface

Item	Specification
Audio Controller	Realtek ALC202 AC97 Codec
Audio onboard or optional	Built-in
Mono or Stereo	Stereo
Resolution	20 bit stereo Digital to analog converter 18 bit stereo Analog to Digital converter
Compatibility	Microsoft PC98/PC99, AC97 2.2 & WHQL
Mixed sound source	Line-in, CD
Sampling rate	48 KHz
Internal microphone	Yes
Internal speaker / Quantity	Yes/2
Supports PnP DMA channel	DMA channel 00
Supports PnP IRQ	IRQ3, IRQ5, IRQ7, IRQ9, IRQ10, IRQ11

Video Interface

Item	Specification
Chip vendor	ATI
Chip name	ATI M7P
Chip voltage	Core/1.25V
Supports ZV (Zoomed Video) port	No

Video Resolutions Mode (for both LCD and CRT)

Resolution	16 bits (High color)	32 bits (True color)
1024x768	Yes	Yes

Video Resolutions Mode (for both LCD and CRT)

Resolution	16 bits (High color)	32 bits (True color)
1400x1050 (SXGA)	Yes	Yes
1600x1200 (UXGA)	Yes	Yes
1280x1024 (Monitor)	Yes	Yes

Parallel Port

Item	Specification
Parallel port controller	SMSC LPC47N227
Number of parallel port	one
Location	Rear side
Connector type	25-pin D-type connector, in female type
Parallel port function control	Enable/Disable/Auto (BIOS or operating system chooses configuration) by BIOS Setup Note: Depending on your operating system, disabling an unused device may help free system resources for other devices.
Supports ECP/EPP/Bi-directional (PS/2 compatible)	Yes (set by BIOS setup) Note: When Mode is selected as EPP mode, "3BCh" will not be available.
Optional ECP DMA channel (in BIOS Setup)	DMA channel 1
Optional parallel port I/O address (in BIOS Setup)	378h, 278h
Optional parallel port IRQ (in BIOS Setup)	IRQ7, IRQ5

USB Port

Item	Specification
USB Compliancy Level	1.1
OHCI	USB 1.1
Number of USB port	2
Location	Right side
Serial port function control	Enable/Disable by BIOS Setup

PCMCIA Port

Item	Specification
PCMCIA controller	O2 OZ6912 CardBus controller
Supports card type	Type II
Number of slots	One type-II
Access location	Right panel
Supports ZV (Zoomed Video) port	No ZV support
Supports 32 bit CardBus	Yes (IRQ11)

System Board Major Chips

Item	Controller
System core logic	Intel 845-PE and ICH4
Super I/O controller	SMsC 47N227, LPC interface
Audio controller	Realtek ALC202 Codec
Video controller	ATI M7P
Hard disk drive controller	ICH4

System Board Major Chips

Item	Controller
Keyboard controller	NS 87591L
RTC	ICH3-M

Keyboard

Item	Specification
Keyboard controller	NS 87591L
Keyboard vendor & model name	Acer proprietary keyboard w/o launch button embedded
Total number of keypads	87/88/90 keys with 101/102 key emulation
Windows logo key	Yes
Internal & external keyboard work simultaneously	Yes

Battery

Item	Specification
Vendor & model name	Sanyo/Sony
Battery Type	Li-ion
Pack capacity	69.93Wh
Cell voltage	3.7V/cell
Number of battery cell	9
Package configuration	Pin 1,2: BATT+: Battery positive power pin
	Pin 3: Floating pin (3S3P)
	Pin 4: B/I: Enable LI-ion battery output, connect to 1k Ω resistor to GND in system.
	Pin 5: TS: connect 10K Ω ohm Thermistor to GND
	Pin 6: EC_SMD1: SMbus DATA
	Pin 7: EC_SMC1: SMbus CLOCK
	Pin 8, 9: GND: battery ground power pin
Package voltage	11.1V

LCD Inverter Specification

This inverter is designed to light up the CCFL of LCD for TravelMate 430 series notebook. It should be supported the following LCD panels.

No.	Supplier	Model	Type
1	CPT	CLAA141XF01	TFT, 14.1" XGA
2	AU	B141XN04	TFT, 14.1" XGA
3	CPT	CLAA150XH01	TFT, 15.0" XGA
4	AU	B150XG01	TFT, 15.0" XGA
5	Hannstar	HDS150PX14-A	TFT 15.0" XGA
6	AU	B150PG01	TFT, 15.0 SXGA+
7	IBM	ITSX95C	TFT 15.0" SXGA+
8	Hitachi	TX38D91VC1FAC	TFT, 15.0" SXGA+

There are two control signals that come from system to control lamp brightness. One signal is named DAC_BRIG, which limits current to meet LCD lamp current specification. Another one is named PWM, which adjusts lamp brightness. This inverter brightness is adjusted by PWM burst

mode. The PWM burst mode is that turning on and off the lamp at rate of 150Hz. The effective brightness is a function of the duty cycle.

Features

1. Wide range 9V to 21V input voltage.
2. Brightness adjustment by PWM duty mode.
3. Close loop controls lamp current.

Electrical Characteristics

No.	Parameter	Symbol	Min.	Typ.	Max.	Unit	Comment
1	Input voltage	NV_PWR	9	14.8	21	V	7.5V (continuous) can work *Note 1
2	Input current	Iin	--	0.33	--	A	
3	Lamp current	IL	3.0	--	6.8	mA	DAC=0V *Note 2
4	Lamp current	IL	2.7	--	6.3	mA	DAC=1V
4	Frequency	F	45	55	65	KHz	* Note 3
5	Output power	Pout	--	--	4.5	W	
6	Efficiency	η	80%	--	--	--	
7	Starting voltage	Vs	1600	--	---	V	At 0°C
8	Starting time	Tvs	1	--	1.5	Sec	
9	Dispoff#		2.8	3.3	3.6	V	Backlight on/off signal
			0	0.5	0.8	V	Low level
10	Limited lamp maximum current	DAC-BRIG	0		3.3	V	*Note 2
11	PWM signal *Note 4	INV_PWM	142	150	158	Hz	PWM signal frequency
			3.0	3.3	3.6	V	PWM signal amplitude
			30	--	100	%	Duty = $\frac{T_{on}}{Period}$
12	Lamp current over-shoot	I zero-PK	--	--	10	%	Line transient (10.8V to 21V/100us) and turn on transient
13	Current Waveform factor	$\frac{I_p}{I_{rms}}$	1.27	$\sqrt{2}$	1.56	Multiple	$\frac{I_{-p}}{I_{rms}}$ or $I_{rms} * 10$
14	Unbalance Rate	$\frac{I_p - I_{-p} }{I_{rms}}$	-10%	0	+10%	Multiple	
15	Turn off current (High side)	IHI	--	--	0	A	PWM=30%
15	Turn off voltage (Low side)	Voff	--	--	150Vp-p	V	PWM=30%

No	Parameter	Symbol	Min.	Typ.	Max.	Unit	Comment
16	Voltage Rise time (Low side)	Trise	--	--	300us	us	PWM=30%
17	Voltage fall time (Low side)	Tfall	--	--	300us	us	PWM=30%

NOTE:

*1. The inverter can work in 7.5V input voltage (continuous), but 7.5V electronic characteristic will not be care.

*2. Limited lamp maximum current by DAC_BRIG signal:

When DAC_BRIG voltage is 0V and INV_PWM enables (100%), lamp has max. current.

When DAC_BRIG voltage is 3.3V and INV_PWM enables (100%), lamp has min. current.

When add 1V DAC, the 100% Lamp current will decrease 0.5mA.

DAC_BRIG signal comes from system chipset with internal resistance of 3K Ω

*3. Inverter operating frequency should be within specification (45~65kHz) at max. and min. brightness load.

*4. INV_PWM enable implies INV_PWM signal is High level (On duty cycle is 100%). It is a square wave of 150Hz to adjust backlight brightness that is a function of PWM duty cycle. Backlight brightness is maximum value under INV_PWM at 100% and brightness is minimum under INV_PWM at 30%.

*5. The system interface signals belong to 3.3V.

*6. Please make sure open lamp output voltage should be within starting voltage specification.

*7. Inverter should pass human body safety test.

*8. Inverter should be no smoking by any component open/short test.

*9. Transformer voltage stress should not be over 85% under any condition.

(turn on overshoot transient and line transient.)

*10. Audio noise should be less than 36dB at 10cm distance.

Electrical specification

No	Symbol	Min.	Typ.	Max.	Unit	Comment
1	V oper*	--	650	--	Vrms	Lamp operating voltage (650+/-50)
	II	6.2	6.5	6.8	mArms	DAC_BRIG: 0 V, PWM: 100%
	II	3.0	3.3	3.6	mArms	DAC_BRIG: 0 V, PWM:30%
	II	5.7	6.0	6.3	mArms	DAC_BRIG: 0V, PWM:100%
	II	2.7	3.0	3.3	mArms	DAC_BRIG: 1V, PWM:30%
	F	45	55	65	kHz	
	η	80%	--	--	--	

Thermal

All components on inverter board should follow below rules:

1. Component using conditions (component stress) must be within component specification including voltage rating, current rating, temperature etc.

2. Component temperature should follow below:

- $\Delta T \leq 30$ degree C, at 25, 35 degree C.
- Component temperature should be less than 70 degree C inside system at 35 degree C.

LCD

Item	Specification					
Vendor & model name	CPT CLAA141 XF01/ CLAA150 XH01	AU B141XN04 UB141X01 B150XG0 1 B150PG0 1	HANNSTAR HSD150P X14-A	IBM ITSX95C	HITACHI TX38D91 VC1FAC	Hannstar HSD150P U13-A
Mechanical Specifications						
LCD display area (diagonal, inch)	14.1	14.1/15.0	15.0	15.0	15.0	15.0
Display technology	TFT	TFT	TFT	TFT	TFT	TFT
Resolution	XGA (1024X 768)	XGA (1024X 768) SXGA+ (1400X 1050)	XGA (1024X 768)	SXGA+ (1400X 1050)	SXGA+ (1400X 1050)	UXGA (1600X 1200)
Supports colors	262K	262K	262K	262K	262K	262K
Optical Specification						
Brightness control	keyboard hotkey	keyboard hotkey	keyboard hotkey	keyboard hotkey	keyboard hotkey	keyboard hotkey
Contrast control	No	No	No	No	No	No
Suspend/Standby control	Yes	Yes	Yes	Yes	Yes	Yes
Electrical Specification						
Supply voltage for LCD display (V)	3.3	3.3	3.3	3.3	3.3	3.3
Supply voltage for LCD backlight (Vrms)	690	690	690	690	690	690

AC Adapter

Item	Specification
Vendor & model name	API API 2AD02-381 90W
Input Requirements	
Maximum input current (A, @100Vac, full load)	1.4Amax@100Vac 0.7Amax@ 240Vac
Nominal frequency (Hz)	47 - 63
Frequency variation range (Hz)	47 - 63
Nominal voltages (Vrms)	90 - 264
Inrush current	The maximum inrush current will be less than 50A and 100A when the adapter is connected to 115Vac(60Hz) and 240Vac(50Hz) respectively.
Efficiency	High efficiency 86% minimum, at 100~240Vac AC input, full load, warm-up condition.

AC Adapter

Item	Specification
Output Ratings (CV mode)	
DC output voltage	Offers constant voltage 19.0V output source with 90W max output power capacity.
Noise + Ripple	300mvp-pmax (20MHz bandwidth) for resistor load
Output current	0 A (min.) 4.74A (max.)
Output Ratings (CC mode)	
DC output voltage	19.0
Constant output	3.5A
Dynamic Output Characteristics	
Start-up time	3 sec. (@115 Vac and 230Vac full load)
Hold up time	10ms min. (@115 Vac input, full load)
Over Voltage Protection (OVP)	26 V
Short circuit protection	Output can be shorted without damage, and auto recovery
Electrostatic discharge (ESD)	15kV (at air discharge) 8kV (at contact discharge)
Dielectric Withstand Voltage	
Primary to secondary	4242 Vdc for 1 second
Leakage current	60uA at 254Vac
Regulatory Requirements	1. FCC class B requirements (USA) 2. VDE class B requirements (German) 3. VCCI classII requirements (Japan)

Power Management

ACPI Mode	Power Management
Mech. Off (G3)	All devices in the system are turned off completely.
Soft Off (G2/S5)	OS initiated shutdown. All devices in the system are turned off completely.
Working (G0/S0)	Individual devices such as the CPU and hard disk may be power managed in this state.
Sleeping State (S3)	CPU in Stop Clock state VGA Suspend PCMCIA Suspend Audio Power Down Hard Disk Power Down Super I/O Low Power mode
Sleeping State (S4)	Also called Hibernate state. System saves all system states and data onto the disk prior to power off the whole system.

Environmental Requirements

Item	Specification
Temperature	
Operating	+0~+40°C
Non-operating	-20~+65°C
Non-operating	-20~+60°C (storage package)
Humidity	
Operating	10% to 90% without condensation at +0~+40°C

Environmental Requirements

Item	Specification
Non-operating	10% to 90% RH, non-condensing (unpacked)
Non-operating	10% to 90% RH, non-condensing (storage package)
Vibration	
Operating (unpacked)	5~500Hz: 0.9G
Non-operating (unpacked)	5~500Hz: 1.3G

Mechanical Specification

Item	Specification
Dimensions	327mm (W) x 269mm (D) x 35.9mm (H) for 14.1/15.0 inch model
Weight	6.6lb (2.99kg) for 14.1 inch model 6.87b (3.117kg) for 15.0 inch model
I/O Ports	One type II CardBus slots, One RJ-11 modem jack, One RJ-45 network jack, One DC-in jack for AC adapter, One ECP/EPP-compliant parallel port, One external monitor port, One headphone/speaker/line-out jack (3.5mm mini jack), One microphone/line-in jack (3.5mm mini jack), One S-video-out (NTSC/PAL) port, Three Universal Serial Bus (USB) ports, One IEEE 1394 port, 100-pin port replicator connector for Acer EasyPort, One SD/MMC slots, One memory stick slot
Drive Bays	two
Material	Recycle plastic PC+ABS 94V0
Indicators	Power, Media activity, Battery charge, Wireless communication, Caps lock, Num lock and Sleep indicators
Switch	Power switch Lid switch Internet switch Wireless ON/OFF switch E-mail switch

Memory Address Map

Memory Address	Size	Function
000E0000h-000FFFFFh	128KB	System BIOS
000C0000h-000CFFFFh	64KB	VGA BIOS
000A0000h-000BFFFFh	128KB	Video memory (VRAM)
00000000h-0009FFFFh	640KB	Conventional memory

I/O Address Map

I/O Address	Function
0000-001F	Direct memory access controller
0000-0CF7	PCI bus
0020-0021	Programmable interrupt controller
0024-0025	Programmable interrupt controller
0028-0029	Programmable interrupt controller
002C-002D	Programmable interrupt controller
002E-002F	Motherboard resources
0030-0031	Programmable interrupt controller
0034-0035	Programmable interrupt controller
0038-0039	Programmable interrupt controller
003C-003D	Programmable interrupt controller

I/O Address Map

I/O Address	Function
0040-0043	System timer
004E-004F	Motherboard resources
0050-0053	System timer
0060-0060	Standard 101/102-Key or Microsoft Natural PS/2 Keyboard
0061-0061	Motherboard resources
0062-0062	Microsoft ACPI-Compliant Embedded Controller
0063-0063	Motherboard resources
0064-0064	Standard 101/102-Key or Microsoft Natural PS/2 Keyboard
0065-0065	Motherboard resources
0066-0066	Microsoft ACPI-Compliant Embedded Controller
0067-0067	Motherboard resources
0070-0077	System CMOS/real time clock
0080-0080	Motherboard resources
0081-008F	Direct memory access controller
0090-0091	Direct memory access controller
0092-0092	Motherboard resources
0093-009F	Direct memory access controller
00A0-00A1	Programmable interrupt controller
00A4-00A5	Programmable interrupt controller
00A8-00A9	Programmable interrupt controller
00AC-00AD	Programmable interrupt controller
00B0-00B1	Programmable interrupt controller
00B4-00B5	Programmable interrupt controller
00B8-00B9	Programmable interrupt controller
00BC-00BD	Programmable interrupt controller
00C0-00DF	Direct memory access controller
00F0-00F0	Numeric data processor
0170-0177	Secondary IDE Channel
01F0-01F7	Primary IDE Channel
0240-0247	Winbond Memory Stick Storage Device Driver(MS)
0248-024F	Winbond Secure Digital Storage (SD/MMC) Device Driver
0274-0277	ISAPNP Read Data Port
0279-0279	ISAPNP Read Data Port
0376-0376	Secondary IDE Channel
0378-037B	ECP Printer Port (LTP1)
03B0-03BB	Intel (R) 82845 Processor to AGP Controller-1A31
03B0-03BB	MOBILITY RADEON 7500
03C0-03DF	Intel (R) 82845 Processor to AGP Controller-1A31
03C0-03DF	MOBILITY RADEON 7500
03F0-03F5	Standard floppy disk controller
03F6-03F6	Primary IDE Channel
03F7-03F7	Standard floppy disk controller
03F8-03FF	Communications Port (COM1)
04D0-04D1	Programmable interrupt controller
0600-060F	Motherboard resources

I/O Address Map

I/O Address	Function
0700-070F	Motherboard resources
0778-077B	ECP Printer Port (LPT1)
0A79-0A79	ISAPNP Read Data Port
0D00-FFFF	PCI Bus
1000-107F	Motherboard resources
1180-11BF	Motherboard resources
1200-120F	Motherboard resources
1800-181F	Intel (R) 82801 CA/CAM USB Universal Host Controller-2487
1820-182F	Intel (r) 82801 CAM Ultra ATA Storage Controller-248A
1840-185F	Intel (R) 82801 CA/CAM SMBus Controller-2483
1860-187F	Intel (R) 82801 CA/CAM USB Universal Host Controller-2482
1880-18BF	Intel (R) 82801 CA/CAM AC'97 Audio Controller
18C0-18DF	Intel (R) 82801 CA/CAM USB Universal Host Controller-2484
1C00-1CFF	Intel (R) 82801 CA/CAM AC'97 Audio Controller
2000-207F	Conexant SoftK56 Data Fax Modem
2400-24FF	Conexant SoftK56 Data Fax Modem
3000-30FF	MOBILITY RADEON 7500
3000-3FFF	Intel (R) 82845 Processor to AGP Controller -1A31
4000-403F	Intel (R) PRO/100 VE Network Connection #2
FC00-FCFF	O2Micro OZ6912 CardBus Controller
FD00-FDFF	O2Micro OZ6912 CardBus Controller
FE00-FE01	Motherboard resources

IRQ Assignment Map

Interrupt Channel	Function(Hardware)
IRQ00	SystemTimer
IRQ01	Keyboard
IRQ02	Programmable Interrupt Controller
IRQ03	Free
IRQ04	Communications Port (COM1)
IRQ05	Winbond Memory Stick Storage (MS) Device Driver
IRQ06	Standard Floppy Disk Controller
IRQ07	ECP Printer Port (LPT1)
IRQ08	System CMOS/real time clock
IRQ09	Conexant SoftK56 Data Fax Modem
	Intel (r) 82801 CA/CAM AC'97 Audio Controller
	Intel (R) 82801 CA/CAM SMBus Controller-2483
	Intel (R) 82801 CA/CAM USB Universal Host Controller-2482
	Intel (R) 82801 CA/CAM USB Universal Host Controller-2484
	Intel (R) 82801 CA/CAM USB Universal Host Controller-2487
	Intel (R) PRO/100 VE Network Connection # 2
	Intersil PRISM Wireless LAN PCI Card
	MOBILITY RADEON 7500
	O2Micro Oz6912 CardBus Controller
	Texas Instruments OHCI Compliant IEEE 1394 Host Controller
IRQ10	Winbond Secure Digital Storage (SD/MMC) Device Driver

IRQ Assignment Map

Interrupt Channel	Function(Hardware)
IRQ11	Free
IRQ12	Alps Pointing-device
IRQ13	Numeric data processor
IRQ14	Primary IDE controller
IRQ15	Secondary IDE controller

DMA Channel Assignment

DMA Channel	Function(Hardware)
1	ECP Printer Port (LPT1)
2	Standard Floppy Disk Controller
4	Direct Memory Access Controller

System Utilities

BIOS Setup Utility

The BIOS Setup Utility is a hardware configuration program built into your computer's BIOS (Basic Input/Output System).

Your computer is already properly configured and optimized, and you do not need to run this utility. However, if you encounter configuration problems, you may need to run Setup. Please also refer to Chapter 4 Troubleshooting when problem arises.

To activate the BIOS Utility, press **F2** during POST (when "Press <F2> to enter Setup" message is prompted on the bottom of screen).

Press F12 to change boot order.

PhoenixBIOS Setup Utility					
Info.	Main	Advanced	Security	Boot	Exit
Item specific Help					
CPU Type	Intel® Pentium® 4				
CPU Speed	3.06 GHz				
Floppy Drive:	1.44/1.25 MB 3 1/2 "				
IDE1 Model Name	TOSHIBA 4K3018GAP-(PM)				
IDE1 Serial Number	Y2554027T				
IDE2 Model Name	Slimtype DVD-ROM SD-081-(SM)				
IDE2 Serial Number					
System BIOS Ver:	TM430_V1.00				
VGA BIOS Ver:	ATI M7-P V0.2				
KBC Ver:	V1.00				
Serial Num:	xxxxxxxxxxxxxxxxxxxx			22 Byte	
Asset Tag Number:	N/A			32 Byte	
Product Name:	TravelMate 430			16 Byte	
Manufacturer Name:	Acer			16 Byte	
UUID:	xxxxxxxxxxxxxxxx			16 Byte	
F1 Help ↑↓ Select Item F5/F6 Change Values F9 Setup defaults Esc Exit ←→ Select Menu Enter Select ▶ Sub-Menu F10 Save and Exit					

Navigating the BIOS Utility

There are six menu options: Info, Main, System Devices, Security, Boot and Exit.

Follow these instructions:

- To choose a menu, use the cursor left/right keys (**←** **→**).
- To choose a parameter, use the cursor up/down keys (**↑** **↓**).

-
- ❑ To change the value of a parameter, press **F5** or **F6**.
 - ❑ Press **ESC** while you are in any of the menu options to go to the Exit menu.
 - ❑ In any menu, you can load default settings by pressing **F9**. You can also press **F10** to save any changes made and exit the BIOS Setup Utility.

NOTE: You can change the value of a parameter if it is enclosed in square brackets. Navigation keys for a particular menu are shown on the bottom of the screen. Help for parameters are found in the Item Specific Help part of the screen. Read this carefully when making changes to parameter values.

Info.

This menu provides you the information of the system.

PhoenixBIOS Setup Utility					
Info.	Main	Advanced	Security	Boot	Exit
Item specific Help					
CPU Type	Intel®Pentium® 4				
CPU Speed	3.06 GHz				
Floppy Drive:	1.44/1.25 MB 3 1/2 "				
IDE1 Model Name	TOSHIBA 4K3018GAP-(PM)				
IDE1 Serial Number	Y2554027T				
IDE2 Model Name	Slimtype DVD-ROM SD-081-(SM)				
IDE2 Serial Number					
System BIOS Ver:	TM430_V1.00				
VGA BIOS Ver:	ATI M7-P V0.2				
KBC Ver:	V1.00				
Serial Num:	xxxxxxxxxxxxxxxxxxxx	22	Byte		
Asset Tag Number:	N/A	32	Byte		
Product Name:	TravelMate 430	16	Byte		
Manufacturer Name:	Acer	16	Byte		
UUID:	xxxxxxxxxxxxxxxx	16	Byte		
F1 Help ↑↓ Select Item F5/F6 Change Values F9 Setup defaults Esc Exit ←→ Select Menu Enter Select ▶ Sub-Menu F10 Save and Exit					

Parameter	Description
Floppy Drive	The Floppy Drive status is auto detected by the system. The information page would display "1.44MB, 3 1/2" if floppy drive exists; it would display "Not installed" if floppy drive does not exist.
IDE1 Model Name	Shows the Model name of HDD installed on Primary IDE master. The system will auto detect the hard disk model name. "None" means the hard disk drive is not existing or unknown type.
IDE1 Serial Number	This item displays the Model Name of HDD installed on Primary IDE master. If no hard disk or other devices are installed on Primary IDE master, this item will display a blank line.
IDE2 Model Name	Displays the Model Name of Device installed on Secondary IDE master. The hard disk or CD-ROM model is automatically detected by the system. If the hard disk drive or CD-ROM is not existing or unknown type, this field would display "None".
IDE2 Serial Number	This field shows the Serial Number of HDD installed on Secondary IDE master. If no hard disk drive or other devices are installed on Primary IDE master, it will display a blank line.
System BIOS Version	Displays system BIOS version
VGA BIOS Version	Displays VGA BIOS version
Serial Number	Displays the serial number of the unit.

Parameter	Description
UUID Number	UUID=16bytes. This will be visible only when there is an internal LAN device present.
System Memory	This field reports the memory size of system base memory. The size is fixed to 640KB.

Main

The Main screen displays a summary of your computer hardware information, and also includes basic setup parameters. It allows the user to specify standard IBM PC AT system parameters.

PhoenixBIOS Setup Utility					
Info.	Main	Advanced	Security	Boot	Exit
					Item specific Help
System Time:		[09:00:00]			
System Date:		[01/01/2003]		<Tab>, <Shift-Tab>, or	
System Memory:		640 KB		Show System Memory Size	
Extended Memory:		127 MB		Show Extended Memory Size	
VGA Memory:		32MB		VGA Memory Size	
Quiet Boot:		[Enabled]			
Power on display:		[Auto]			
LCD Auto Dim:		[Enabled]			
PXE Boot From LAN		[Enabled]			
F12 Boot Menu		[Disabled]			
F1 Help	↑↓ Select Item	F5/F6 Change Values	F9 Setup defaults		
Esc Exit	←→ Select Menu	Enter Select ▶ Sub-Menu	F10 Save and Exit		

NOTE: The screen above is for reference only. Actual values may differ.

The table below describes the parameters in this screen. Settings in **boldface** are the default and suggested parameter settings.

Parameter	Description	Format/Option
System Time	Sets the system time.	Format: HH:MM:SS (hour:minute:second) System Time
System Date	Sets the system date.	Format MM/DD/YYYY (month/day/year) System Date
System Memory	This field reports the memory size of system base memory.	The size is fixed to 640KB.
Extended Memory	This field reports the memory size of the extended memory in the system. Extended Memory size=Total memory size-1MB	
VGA Memory	VGA Memory size=16MB	
Quiet Boot	Control whether Customer Logo and Summary Screen are displayed or not.	Option: Enabled or Disabled
Power on Display	Auto: During power on process, the system will detect if any display device is connected on external video port. If any external display device is connected, the power on display will be in CRT (or projector) only mode. Otherwise the system will be in LCD only mode. Both: Simultaneously enable both the integrated LCD screen and the system's external video port (for an external CRT or projector).	Option: Auto or Both
LCD Auto Dim	Enabled: LCD brightness will automatically lower to save more power when AC is not present. Disabled: LCD brightness will NOT automatically lower to save more power when AC is not present.	Option: Enabled or Disabled
F12 Boot Menu	This field decides whether the OEM POST screen will have the following message: "Press <F12> Change Boot Device" or not during user's quiet boot.	Option: Enabled or Disabled

NOTE: The sub-items under each device will not be shown if the device control is set to disable or auto. This is because the user is not allowed to control the settings in these cases.

Advanced

The System Devices screen contains parameters involving your hardware devices. It also provides advanced settings of the system.

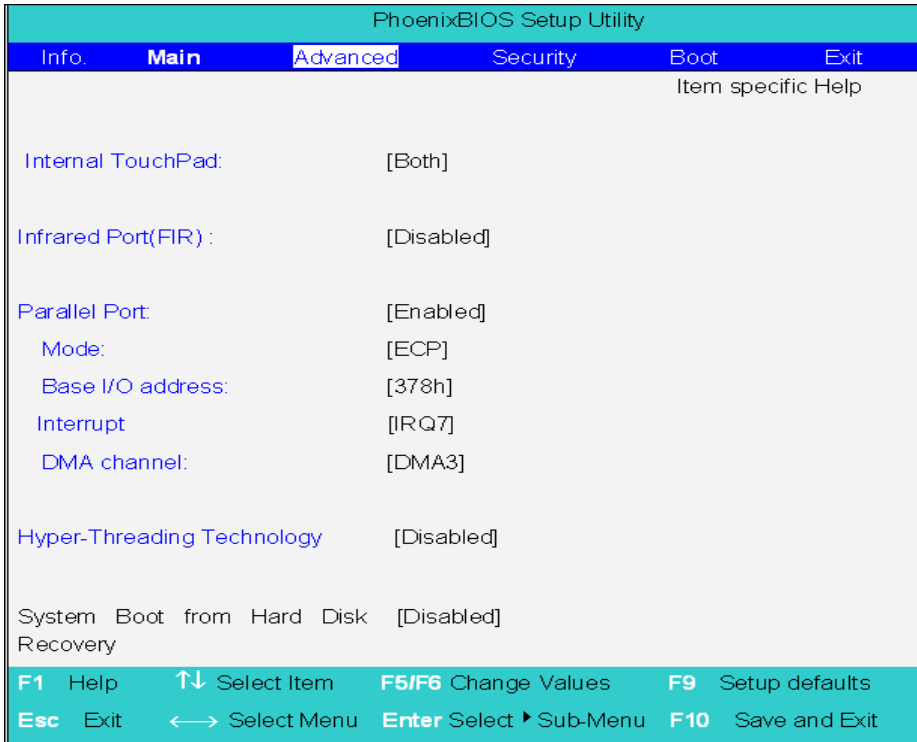

The table below describes the parameters in the screen. Settings in **boldface** are the default and suggested parameter settings.

Parameter	Description	Options
Internal TouchPad	Determines whether or not to disable the internal touchpad of a PS/2 pointing device is connected.	Both or Auto
Infrared Port (FIR)	Sets the interrupt request of the serial port. Please set the parameter to "Enabled" if you need to use FIR under Windows operation system.	Disabled/ Enabled/ Auto
Base I/O address/IRQ	Sets the I/O address of the Infrared port.	3F8h/IRQ4; 2F8h/IRQ3; 2E8h/IRQ3
DMA	Sets a DMA channel for the printer to operate in disabled mode.	DMA1/ DMA3
Parallel Port	Enables, disables or auto detects the parallel port.	Enabled/ Disabled/Auto
Mode	Sets the operation mode of the parallel port.	ECP, EPP, Normal or Bi-directional
Base I/O address/	Sets the I/O address of the parallel port. This parameter is enabled only if Mode is set to ECP or Bi-directional.	378h, 278h or 3BCb
Interrupt	Sets the interrupt request of the parallel port.	IRQ 7 or IRQ5
DMA Channel	Sets a DMA channel for the printer to operate in ECP mode. This parameter is enabled only if Mode is set to ECP.	DMA3 or DMA1

Security

The Security screen contains parameters that help safeguard and protect your computer from unauthorized use.

PhoenixBIOS Setup Utility					
Info.	Main	Advanced	Security	Boot	Exit
				Item specific Help	
User Password is		Clear			
Supervisor Password is		Clear			
Set User Password		[Enter]			
Set Supervisor Password		[Enter]		Supervisor Password controls access to the setup utility	
Primary HardDisk Security:		[Disabled]			
Password on Boot:		[Disabled]			
F1 Help	↑↓ Select Item	F5/F6 Change Values	F9 Setup defaults		
Esc Exit	←→ Select Menu	Enter Select	▶ Sub-Menu	F10 Save and Exit	

The table below describes the parameters in this screen. Settings in **boldface** are the default and suggested parameter settings.

Parameter	Description	Option
User Password is	Shows the setting of the user password.	Clear or Set
Supervisor Password is	Shows the setting of the Supervisor password	Clear or Set
Set User Password	Press Enter to set the user password. When set, this password protects the BIOS Setup Utility from unauthorized access.	
Set Supervisor Password	Press Enter to set the administrator password. When set, this password protects the BIOS Setup Utility from unauthorized access.	
Primary Harddisk Security	This feature is available to user when Supervisor password is set. Password can be written on HDD only when Supervisor password or user password is set and password on HDD is set to enabled. Supervisor Password is written to HDD only when Supervisor password is being set. User password is written to HDD when both passwords are set. When both Supervisor and user password are present, both passwords can unlock the HDD.	Disabled or Enabled
Password on Boot	Defines whether a password is required or not while the events defined in this group happened. The following sub-options are all requires the Supervisor password for changes and should be grayed out if the user password was used to enter setup.	Disabled or Enabled

NOTE: When you are prompted to enter a password, you have three tries before the system halts. Don't forget your password. If you forget your password, you may have to return your notebook computer to your dealer to reset it.

Setting a Password

Follow these steps as you set the user or the administrator password:

1. Use the **↑** and **↓** keys to highlight the Set Administrator Password parameter and press the **ENTER** key. The Set Administrator Password box appears:

Set SupervisorPassword

Enter New Password
[]

Confirm New Password
[]

2. Type a password in the Enter new password field. The password length can not exceeds 8 alphanumeric characters (A-Z, a-z, 0-9, not case sensitive). Retype the password in the Confirm new password field.

IMPORTANT: Be very careful when typing your password because the characters do not appear on the screen.

3. Press **ENTER**.
After setting the password, the computer sets the User Password parameter to "Set".
4. If desired, you can opt to enable the Password on boot parameter.
5. When you are done, press **F10** to save the changes and exit the BIOS Setup Utility.

Removing a Password

Follow these steps:

1. Use the **↑** and **↓** keys to highlight the Set User Password parameter and press the **ENTER** key. The Set Password box appears:

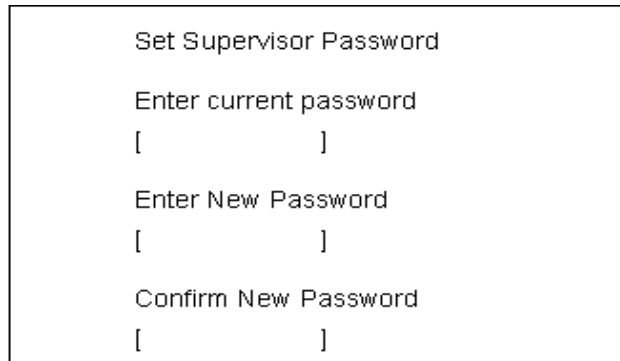

```
Set Supervisor Password

Enter current password
[           ]

Enter New Password
[           ]

Confirm New Password
[           ]
```

2. Type the current password in the Enter Current Password field and press **ENTER**.
3. Press **ENTER** twice **without** typing anything in the Enter New Password and Confirm New Password fields. The computer then sets the Administrator Password parameter to "Clear".
4. When you have changed the settings, press **F10** to save the changes and exit the BIOS Setup Utility.

Changing a Password

1. Use the **↑** and **↓** keys to highlight the Set User Password parameter and press the **ENTER** key. The Set Password box appears:

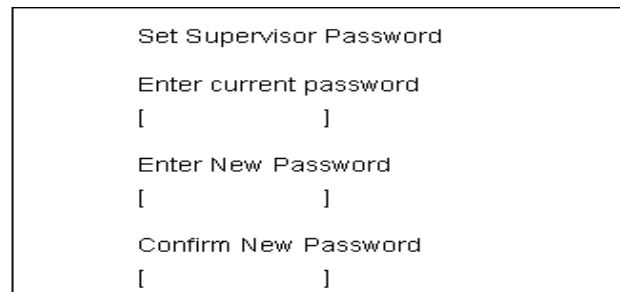

```
Set Supervisor Password

Enter current password
[           ]

Enter New Password
[           ]

Confirm New Password
[           ]
```

2. Type the current password in the Enter Current Password field and press **ENTER**.
3. Type a password in the Enter New Password field. Retype the password in the Confirm New Password field.
4. Press **ENTER**. After setting the password, the computer sets the User Password parameter to "Set".
5. If desired, you can enable the Password on boot parameter.
6. When you are done, press **F10** to save the changes and exit the BIOS Setup Utility.

If the verification is OK, the screen will display as following.

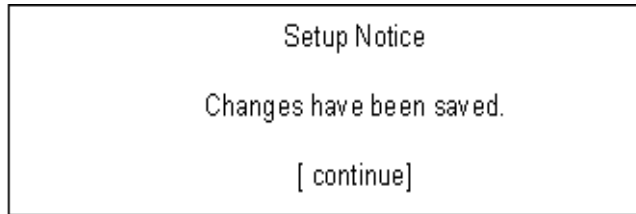

The password setting is complete after the user presses .

If the current password entered does not match the actual current password, the screen will show you the Setup Warning.

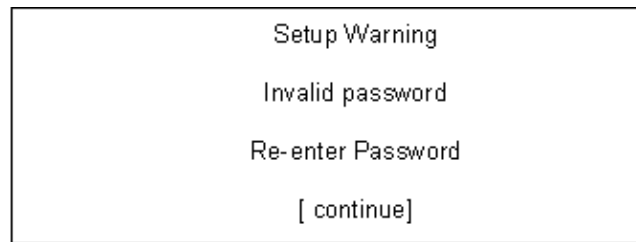

If the new password and confirm new password strings do not match, the screen will display the following message.

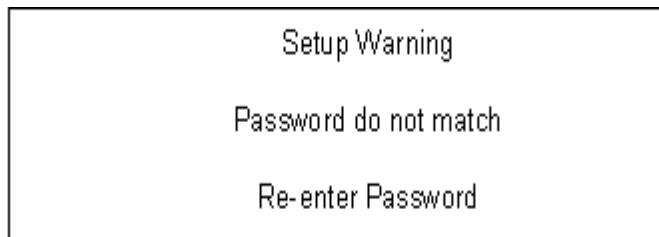

Boot

This menu allows the user to decide the order of boot devices to load the operating system. Bootable devices includes the distette drive in module bay, the onboard hard disk drive and the CD-ROM in module bay.

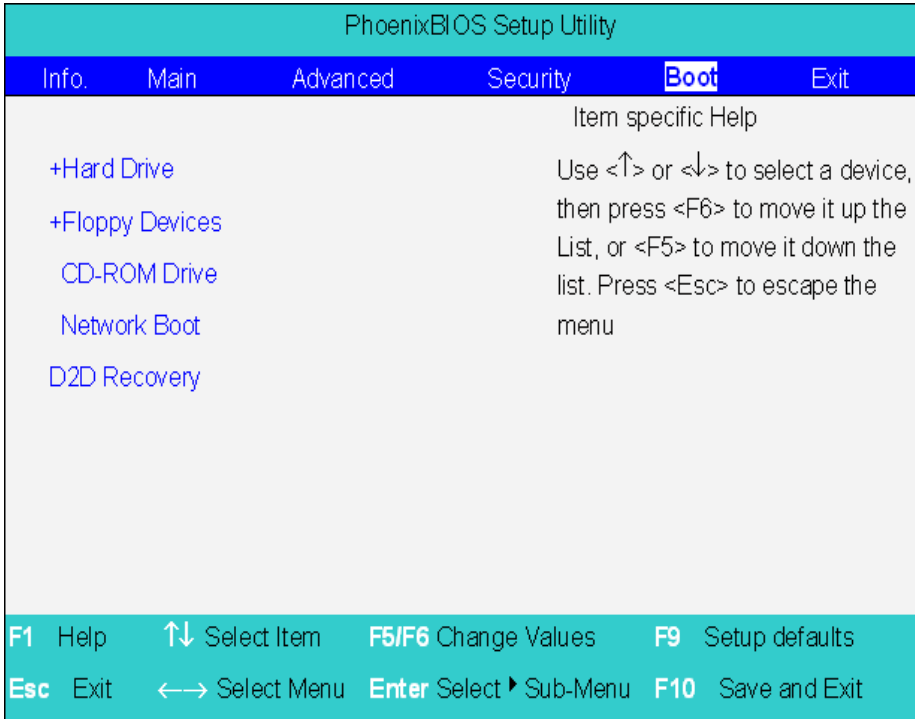

Exit

The Exit screen contains parameters that help safeguard and protect your computer from unauthorized use.

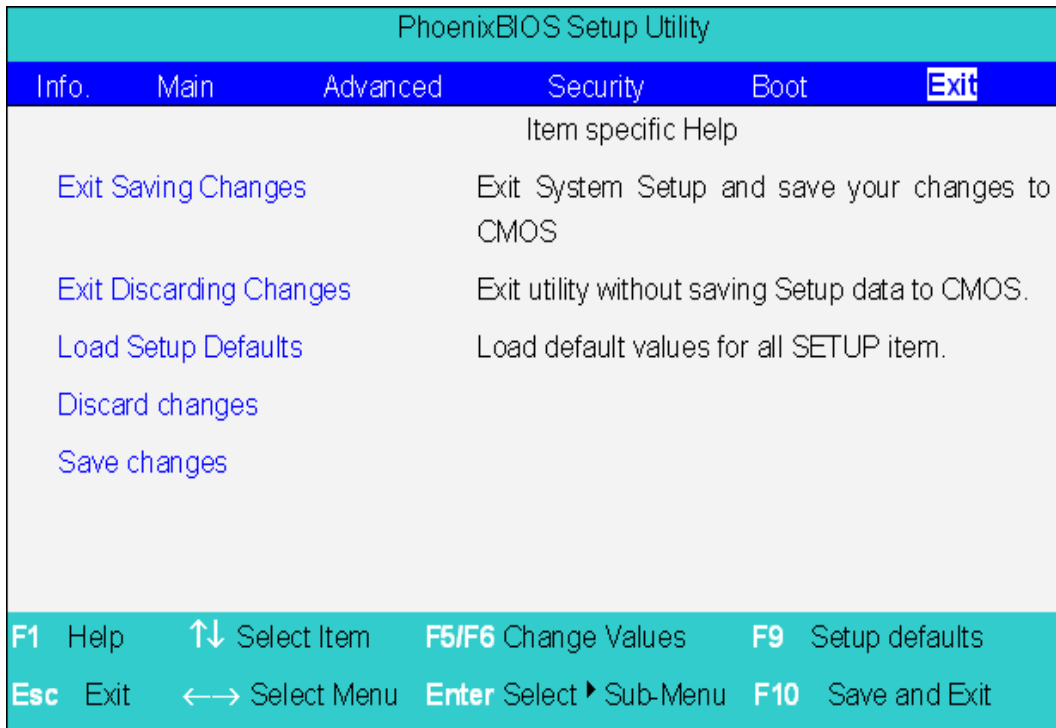

The table below describes the parameters in this screen.

Parameter	Description
Exit Saving Changes	Allows the user to save changes to CMOS and reboot the system.
Exit Discarding Changes	Allows the user Discards changes made and exits System Setup.
Load Setup Default	Loads default settings for all parameters (same as ).
Discard Changes	Allows the user to discard previous changes in CMOS Setup.
Save Changes	Allows the user to save current changes in CMOS Setup.

BIOS Flash Utility

The BIOS flash memory update is required for the following conditions:

- New versions of system programs
- New features or options
- Restore a BIOS when it becomes corrupted.

Use the Flash utility to update the system BIOS flash ROM.

NOTE: If you do not have a crisis recovery diskette at hand, then you should create a **Crisis Recovery Diskette** before you use the Flash utility.

NOTE: Do not install memory-related drivers (XMS, EMS, DPMS) when you use the Flash utilities.

NOTE: Please use the AC adaptor power supply when you run the Flash utility. If the battery pack does not contain enough power to finish BIOS flash, you may not boot the system because the BIOS is not completely loaded.

Follow the steps below to run the Flash.

1. Prepare a bootable diskette.
2. Copy the Flash utilities to the bootable diskette.
3. Then boot the system from the bootable diskette. The Flash utility has auto-execution function.

System Diagnostic Diskette

This diagnostic diskette is for the Acer TravelMate 430 series notebook machine. You can find the utility in Service CD kit. It provides the following functions:

1. RTC Function Test
2. PIO Loop Back Test
3. CD ROM Function Test
4. Touchpad and USB Mouse Test
5. Video Model (R.G.B.) Test
6. Internal Keyboard Test
7. Num/Caps/Scroll Key Lock Test
8. Battery (Charge/Discharge) Test
9. Audio Test
10. Audio CD Play Function Test
11. Lid Switch Function Test
12. Easy Button Function Test
13. FAN Test
14. CRT Output Function Test

To use the diagnostic programs, and system utilities, please boot the system from this service CD. The diagnostic programs contain autorun function under DOS. Please select the item you want to test under DOS mode according to the menu.

IMPORTANT: ¹The diagnostics program we use for TravelMate 430 series is not exactly the same as PQA (Product Quality Assurance), the diagnostic program we used to employ in other model. The system diagnostic utilities is provided by Acer Headquarters. You can utilize it as a basic diagnostic tool. To get this program, find it in the TravelMate 430 series service CD kit. To better fit local service

¹ New added description. Please pay attention to it.

requirements, your regional office MAY have other diagnostic program. Please contact your regional offices or the responsible personnel/channel to provide you with further technical details.

NOTE: For ASSY Function Test Procedure, please prepare the following items for system components test: PC (with FIR port), 1394 HDD, PS2 mouse, PS2 Ext-KB, CRT monitor, USB mouse, CD-ROM, DVD-ROM disc (with data and audio track), external speaker, internal CD-ROM module, internal DVD-ROM module, SD card, MS card, AC adapter (90W), TV.

NOTE: As running the testing utility, please do use the right AC adapter (90W, 19V/4740mA). If you use AC adapter lower than 90W, it will damage notebook computer power circuit material.

Running Diagnostics Program

1. RTC Function Test

Run the RTC Function Test program.



```
LAP:00000(0000:00) 12:39:49 COMPAL TSEL/F: IN:1 Version:1.65
00 RTC/CALENDAR
Wait for zero counter...
Testing...12:39:49
```

2. PIO Loop Back Test

Insert PIO loopback fixture to main board PIO connect then run the testing program.

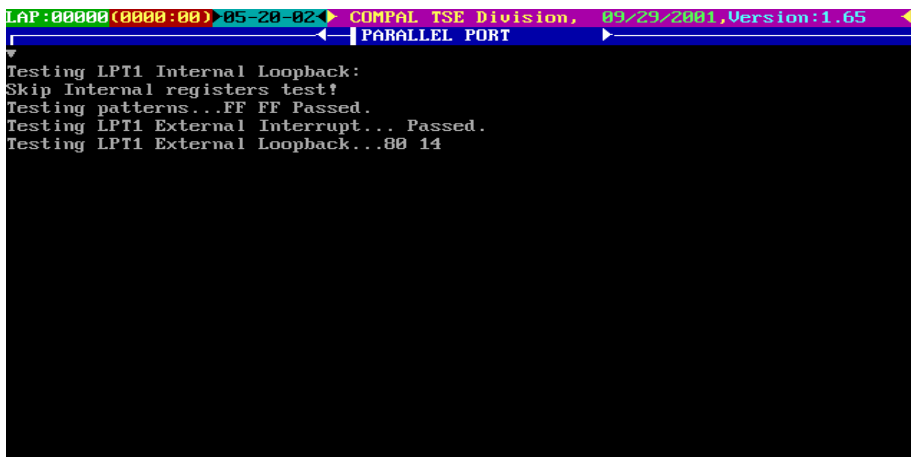

```
LAP:00000(0000:00) 05-20-02 COMPAL TSE Division, 09/29/2001,Version:1.65
PARALLEL PORT
Testing LPT1 Internal Loopback:
Skip Internal registers test!
Testing patterns...FF FF Passed.
Testing LPT1 External Interrupt... Passed.
Testing LPT1 External Loopback...80 14
```

3. CD-ROM Function Test

Insert a data CD to CD-ROM drive. Then check the CD-ROM drive function with CD-ROM Function Test.

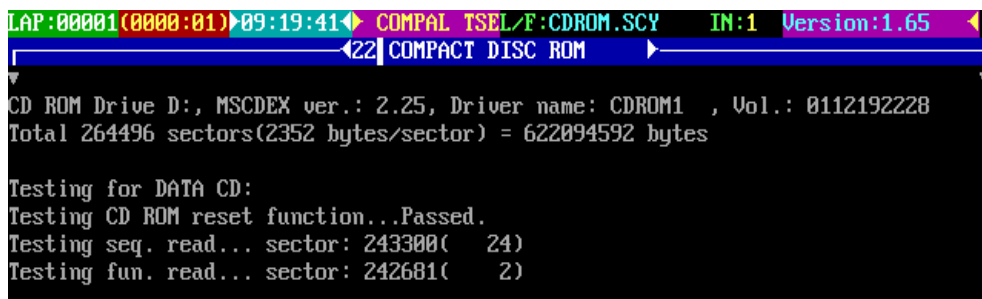

```
LAP:00001(0000:01) 09:19:41 COMPAL TSEL/F:CDROM.SCY IN:1 Version:1.65
22 COMPACT DISC ROM
CD ROM Drive D:, MSCDEX ver.: 2.25, Driver name: CDR0M1 , Vol.: 0112192228
Total 264496 sectors(2352 bytes/sector) = 622094592 bytes
Testing for DATA CD:
Testing CD ROM reset function...Passed.
Testing seq. read... sector: 243300( 24)
Testing fun. read... sector: 242681( 2)
```

4. Touchpad and USB Mouse Test

This utility can test touchpad and USB ports.

The three USB ports locate on the right panel. Please insert a USB mouse to USB port 1, port 2 and port 3. As you run the testing utility, please test port 1 and port 2 first. Move the mouse and click the left and the right button to test its functions. After USB port 1 and port two have been checked, please insert the mouse to the third USB port for testing. Move the mouse and click the right and the left button to see if it works fine.

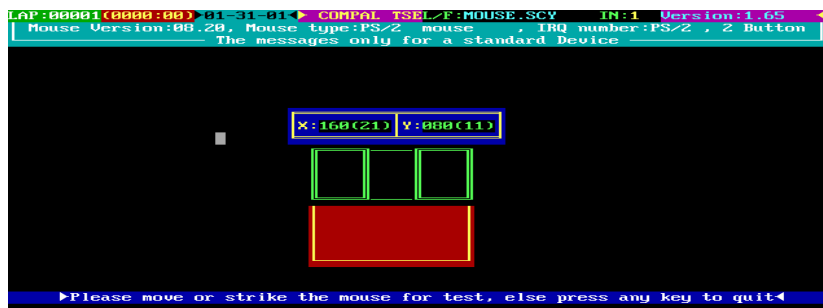

USB Port 1



USB Port 2



USB Port 3

5. Video Model (R. G. B.) Test

Use the utility to test LCD color (red, green, blue, white, black) mode. Please press "Enter" key to continue each color display.

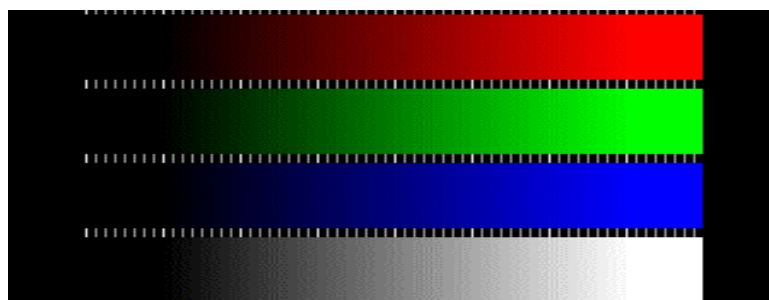

6. Internal Keyboard Test

Run the Internal Keyboard Test. Press the key one by one to see if it functions well or not. If suspect a certain key has problem, please press "B" key to test the key again.

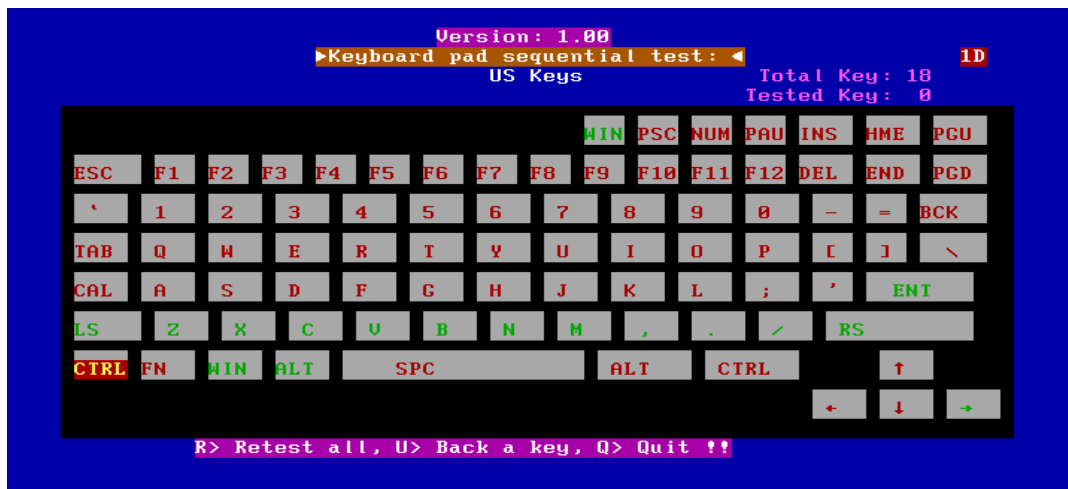

7. Num/Caps/Scroll Key Lock Test

Press the FN+Num/Caps key. Then check if the FN+Num/Caps media LED is emitting or not.

8. Battery (Charge/Discharge) Test

Use Battery Test to check AC adapter function and charging LED. Please plug in the AC adapter before you run the testing utility. If the battery capacity is more than 95%, it will always pass the test.

IMPORTANT:As running the testing utility, please do use the right AC adapter (90W, 19V/4740mA). If you use AC adapter lower than 90W, it will damage notebook computer power circuit material.

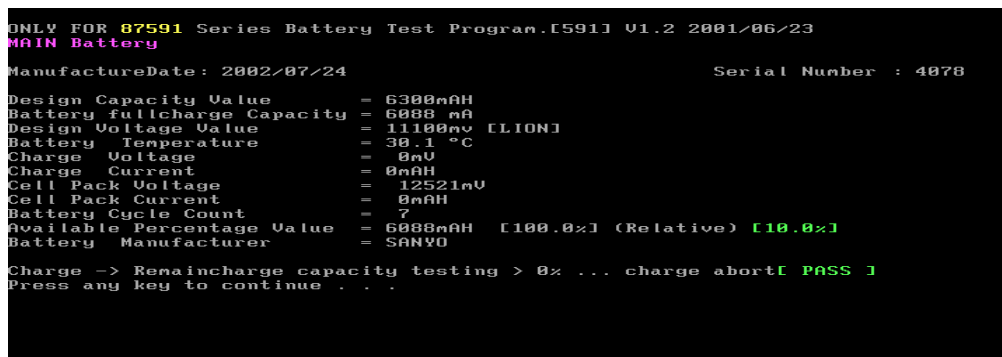

9. Audio Test

Use this utility to test audio function. Please test internal speakers first. Then insert the external speakers to speaker phone jack and see if it functions normally. Listen to the sound emitting from the left and the right speakers (both internal and external).

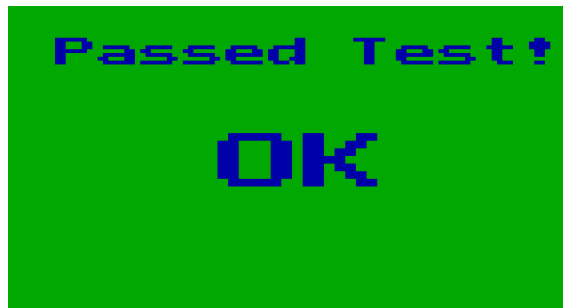
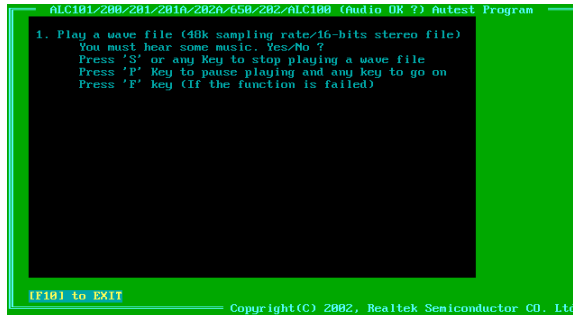

10. Audio CD Play Function Test

Put a music compact disc in CD-ROM drive. Click “Play” button that display on the LCD/or external CRT monitor to play the music disc. Then click on other function keys to test its functions. Click on “QUIT” to exit the testing.

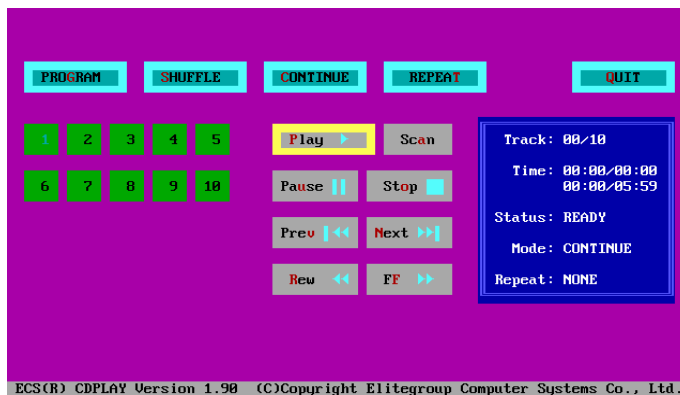

11. Lid Switch Function Test

Please use the utility to test the Lid Switch Function.

Close the LCD to press “Lid switch” for testing. Then check if the LCD backlight is on or off.

```
-----Lid Suspend Function test -----  
  
Please will LCD Module lock ,Test (LCD backlight)  
Press any key to continue . . .
```

12. Easy Button Function Test

Please press the launch keys and audio controls respectively to see if they work normally. Launch keys locate on the middle cover; audio controls locate on the front panel. Once you press any launch key or audio control, the button displaying on the LCD/CRT monitor will disappear at the same time.

```
BPL16 Easy Button Test Program Written By Compal SW Team V1.0 2002/08/16  
0fdf  
38  
P1 P2 Mail Exp  
UL+ UL- << >> > = DS W/B  
*** Keyin <ESC> To Quit ***
```

NOTE: Please also note the FIR LED colors. It emits orange for Wireless mode; green for bluetooth mode. If FIR LED does not light up, it means there is no wireless function.

13. FAN Test

Run FAN test program to check if fan wire and fan function works normally.

```
*** Fan Test Program V1.5 2001/10/22 ***  
Fan Test .. Wait 3 Sec
```

14. CRT Output Function Test

Run CRT output function test to see if CRT displays well. Please plug in CRT cable to monitor connector. FAN test program to check if fan wire and fan function works normally. Press "Fn+F5" to switch to CRT monitor and LCD. This utility mainly checks if you can be switch to LCD and CRT monitor on this notebook computer.

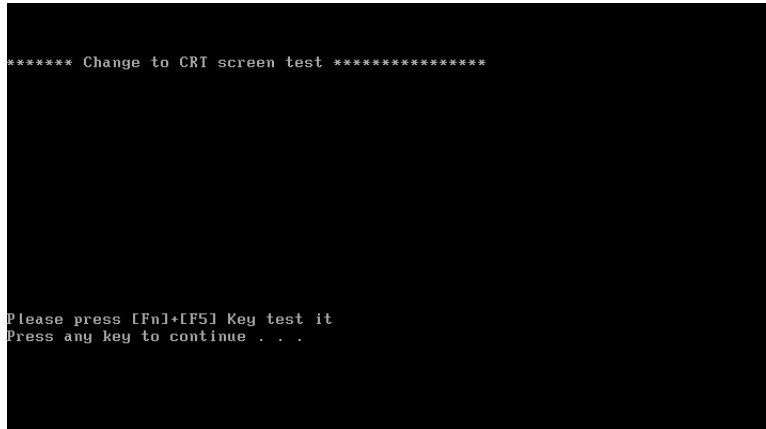

Machine Disassembly and Replacement

This chapter contains step-by-step procedures on how to disassemble the notebook computer for maintenance and troubleshooting.

To disassemble the computer, you need the following tools:

- Wrist grounding strap and conductive mat for preventing electrostatic discharge
- Flat head screw driver
- Tweezers
- Plastic screw driver
- Nut driver
- Philips screw driver

NOTE: The screws for the different components vary in size. During the disassembly process, group the screws with the corresponding components to avoid mismatch when putting back the components. When you remove the stripe cover, please be careful not to scrape the cover.

General Information

Before You Begin

Before proceeding with the disassembly procedure, make sure that you do the following:

1. Turn off the power to the system and all peripherals.
2. Unplug the AC adapter and all power and signal cables from the system.
3. Remove the battery pack.

NOTE: TravelMate 430 series product uses mylar or tape to fasten the FFC/FPC/connectors/cable, you may need to tear the tape or mylar before you disconnect different FFC/FPC/connectors.

Disassembly Procedure Flowchart

The flowchart on the succeeding page gives you a graphic representation on the entire disassembly sequence and instructs you on the components that need to be removed during servicing. For example, if you want to remove the system board, you must first remove the keyboard, then disassemble the inside assembly frame in that order.

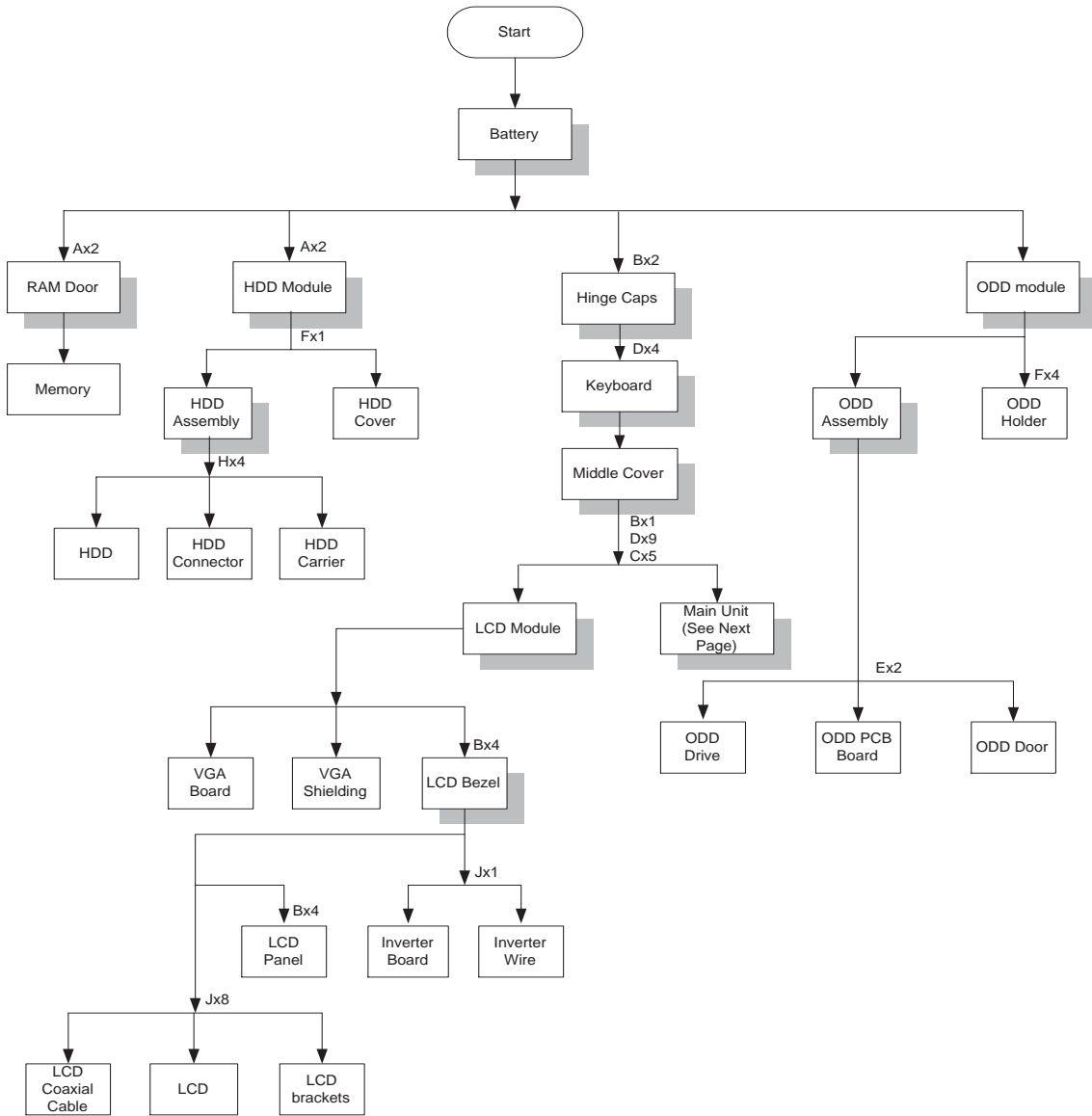

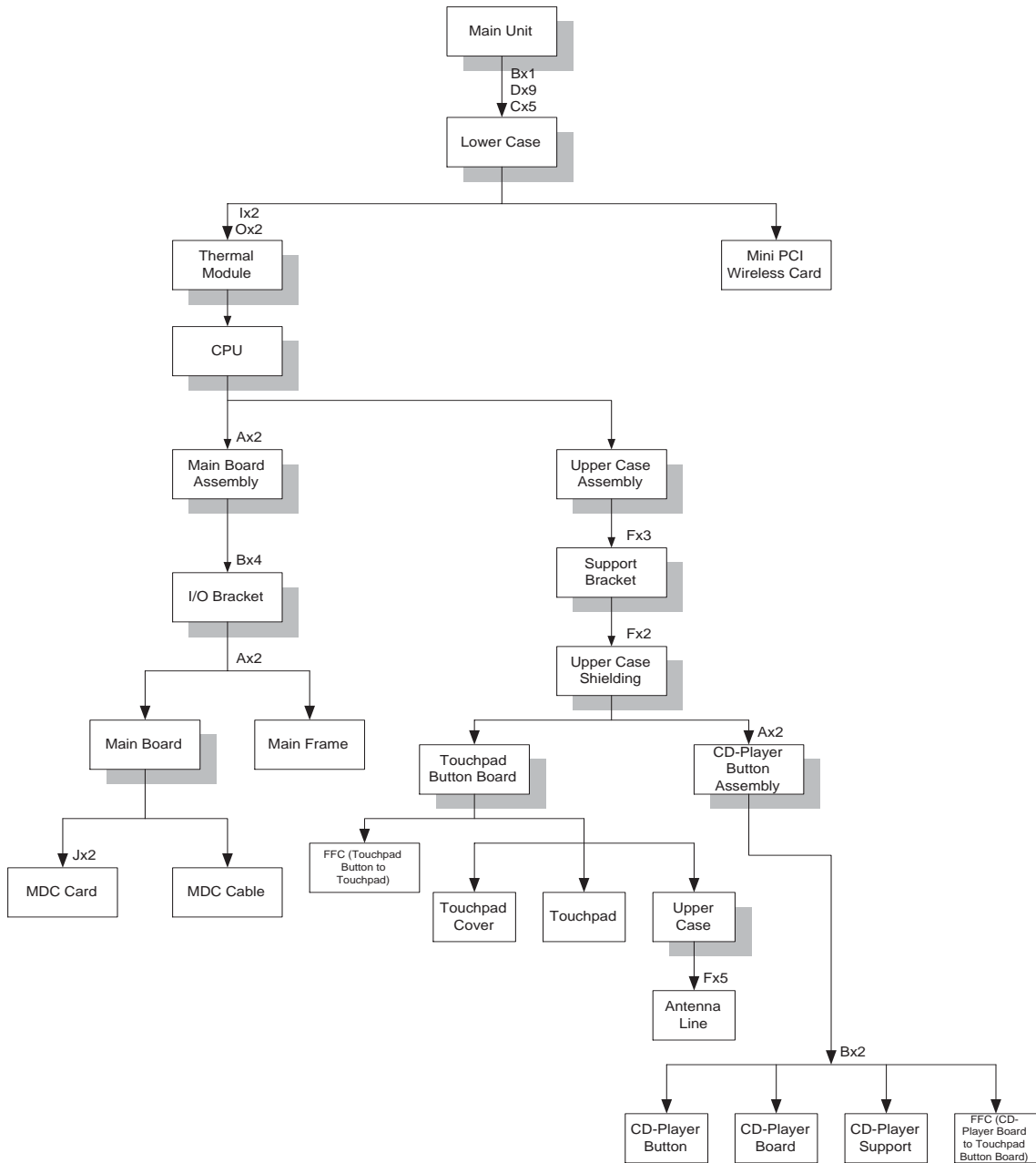

Screw List

Item	Description
A	SCREW M2.5X0.45+4A-BNI
B	SAFETY SCREW M2.5X0.45+6FP-ZK(NL)
C	SCREW M2.5X0.45+10FP-ZK(NL)
D	SCREW M2.5X0.45+16FP-ZK (NL)
E	SCREW M2.0X4FP-ZK(H3.5-3.8XT0.6)
F	SCREW M2.5X0.45P+3K-ZK(NL)
G	SCREW M2.0X0.4P+2.3FP-ZK
H	SCREW M3.0X0.8+3K-NL
I	THERMAL SCREW (Front)
J	SCREW M2.0X0.4P+3FP-NI

Removing the Battery Pack

1. Slide the battery latch as the picture shows.
2. Then remove the battery.



Removing the Optical Module/HDD Module and Memory

Removing the Optical Module

1. Slide the optical drive latch.
2. Then remove the optical drive.

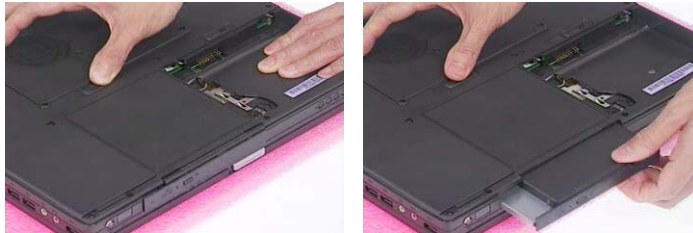

Removing the HDD module

1. Unscrew the two screws that secure the hard disk drive door.
2. Remove the hard disk drive module.

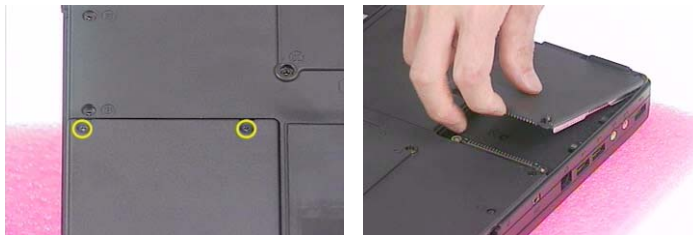

Removing the Memory

1. Remove the two screws that secure the RAM door.
2. Remove the RAM door.
3. Prize the retaining clips with fingers. Then remove the memory.



Removing the Keyboard/ LCD Module and VGA Board

Removing the Keyboard

1. Remove the two screws holding the hinge caps then remove the hinge caps.
2. Unscrew the four screws holding the keyboard.
3. Use a tool to press the keyboard lock latch on the right and the left side.

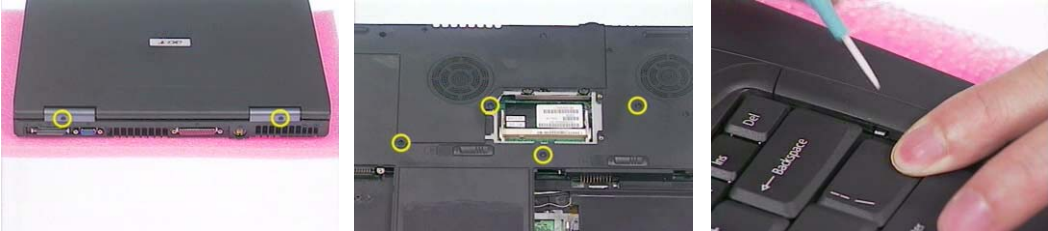

4. Turn over the keyboard as the picture shows.
5. Disconnect keyboard FFC then remove the keyboard.
6. Then detach the middle cover carefully.

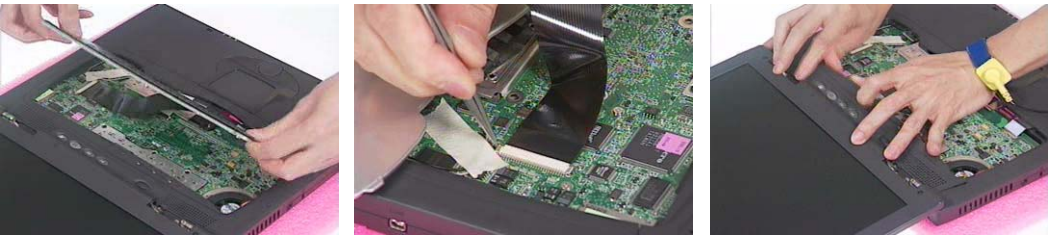

Removing the LCD module and VGA Board

1. See "Removing the Keyboard" on page 65.
2. Remove one screw as the picture shows.
3. Remove the six screws on the rear panel and bottom panel. Three on each side.
4. Unscrew the four screws holding the VGA board assembly to the main board.



NOTE: Please make sure you have remove the screw that is near the ventilation hole as step 2 shows. Otherwise, you may damage the VGA board while you need to remove it. That screw secures the VGA board as well.

5. Disconnect the LCD inverter connector.

6. Then disconnect the VGA board connector.
7. Tilt the LCD module to 90 degree from the main unit.



8. Remove the LCD module from the main unit.
9. Detach the mylar that fastens then take the cable out of VGA shielding notch.
10. Disconnect the LCD coaxial cable from the VGA board.
11. Remove the VGA shielding from the VGA board.

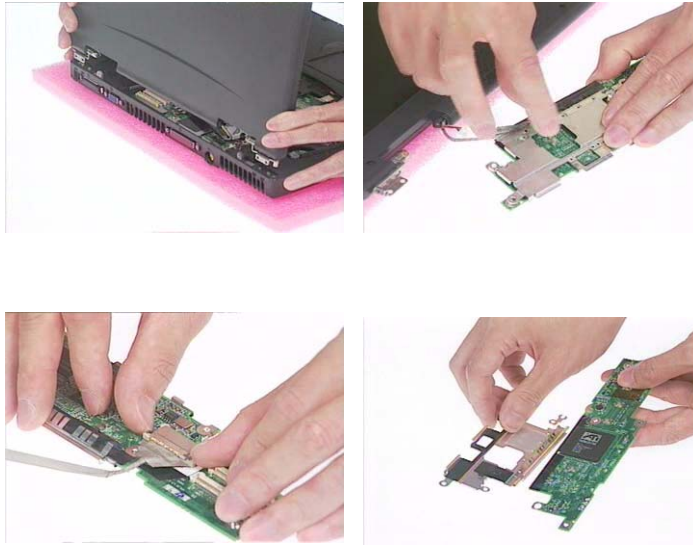

Disassembling the Main Unit

1. See "Removing the Keyboard/ LCD Module and VGA Board" on page 65
2. Disconnect the left and the right speaker cable.
3. Disconnect the touchpad FFC.

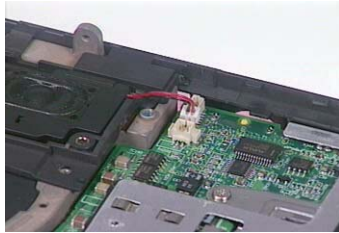

4. Remove the 12 screws on the lower case.
5. Then detach the lower case from the main unit.

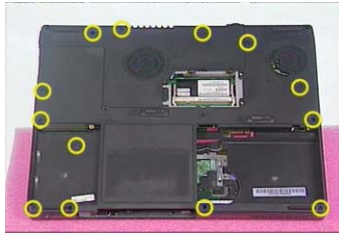

6. Disconnect the antenna line connectors that connects to the mini PCI wireless card.
7. Release the mini PCI wireless card lock with the fingers then remove it.



8. Unscrew the four screws that fasten the thermal module.
9. Remove the thermal module from the main unit.

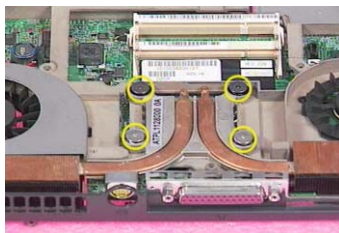

10. Release the CPU lock.
11. Remove the CPU from the main unit carefully.
12. Tear off the tape that fastens the antenna line to the main board. Then take the antenna line out from the other side.



13. Remove the screw here.
14. Unscrew the screw as shown here.
15. Then remove the main board assembly from the lower case.



16. Unscrew the four screw nuts that secure the I/O bracket.
17. Remove the screw on the main frame.
18. Disconnect one fan connector.

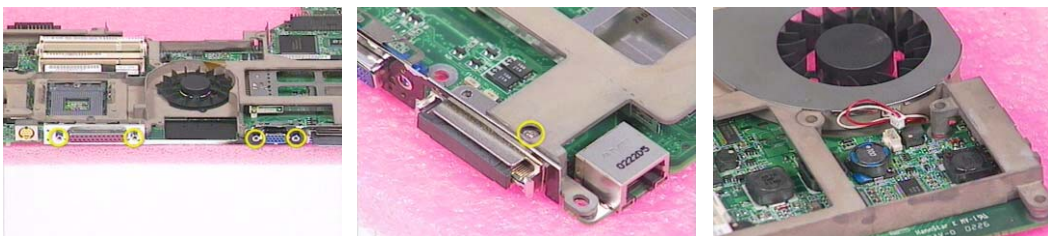

19. Disconnect another fan connector.
20. Remove the four screws that fasten the I/O bracket to the main frame.
21. Detach the I/O bracket from the main board.

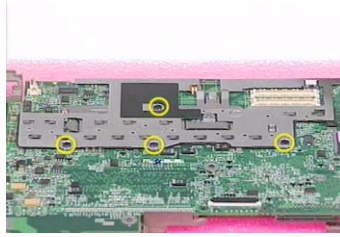

22. Unscrew the two screws holding the main board to the main frame.
23. Remove main board from the main frame.
24. Remove the two screws holding the MDC card.
25. Disconnect the MDC card connector and modem wire. Then remove the MDC card.
26. Insert the pins of the tweezers to the holes as red circles highlight. Press the tweezers inwards as the yellow arrows show. Then pull out the connector.
27. Then remove the MDC cable.

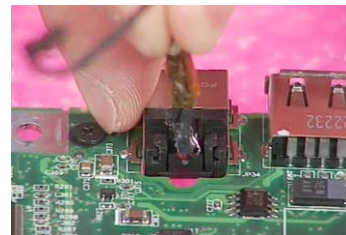
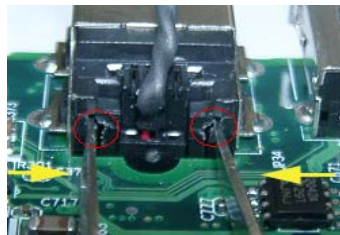
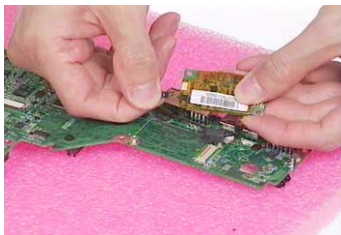
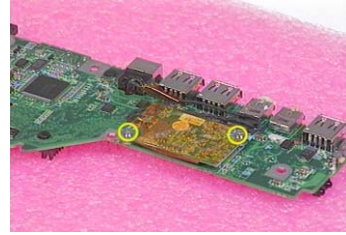

NOTE: Please see the image below for the tweezers used. You can also use any tweezers as long as it will not damage MDC cable connector.



Specification: AA120mm

28. Remove the three holding the support bracket.
29. Remove the support bracket.

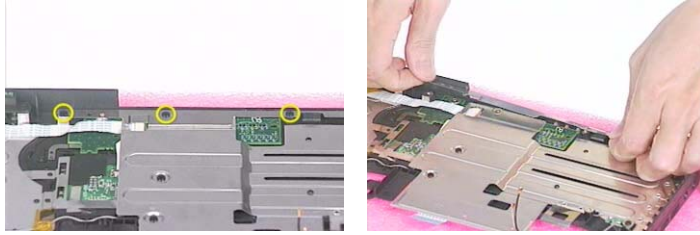

30. Unscrew the three screws that secure the upper case shielding.
31. Then remove the upper case shielding.
32. Disconnect the FFC then remove it.

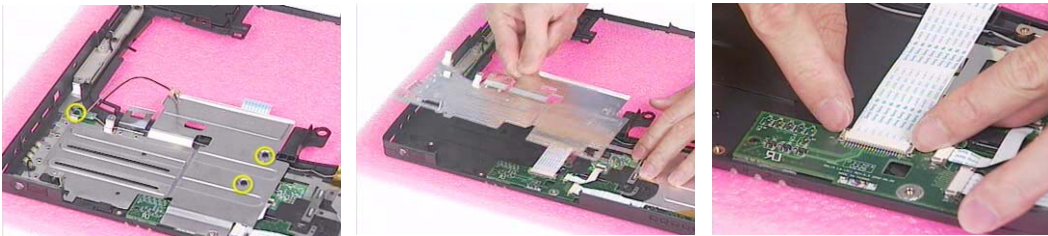

33. Release the tape that fasten touchpad button board FFC. Then disconnect the FFC connecting to touchpad button board.
34. Unscrew the two screws that secure the CD player board.



35. Take the CD player board off the lower case.
36. Remove the two screws holding CD-player button and CD-player support.
37. Remove the CD-player button.



38. Press the CD-player support latch.
39. Then remove the CD-player support.

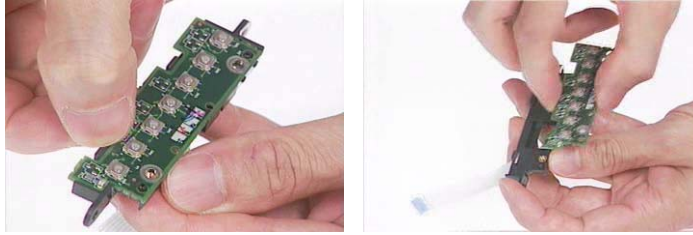

40. Disconnect the FFC on the CD-player button.
41. Disconnect the FFC that connects to the touchpad button board.
42. Take the touchpad button board off the upper case.

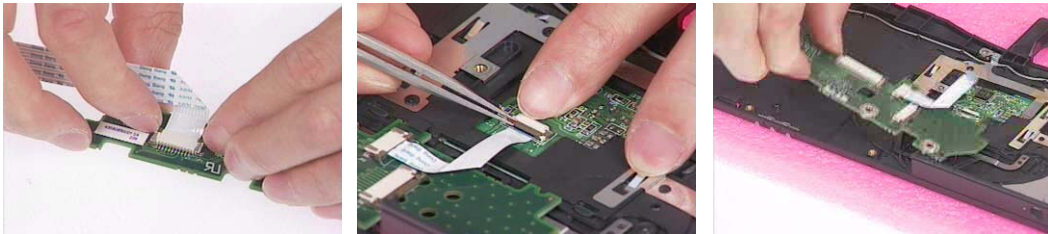

43. Disconnect the touchpad button board FFC.
44. Release nine locks that secure the touchpad cover.
45. Detach the touchpad cover.

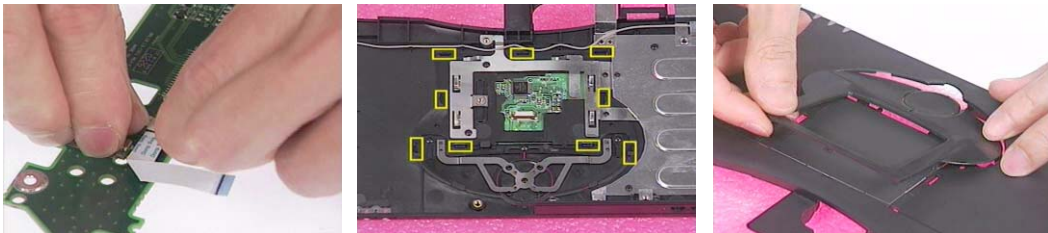

46. Remove the touchpad.
47. Unscrew the four screws holding the antenna line. Two on each side.
48. Remove the antenna line from the upper case.

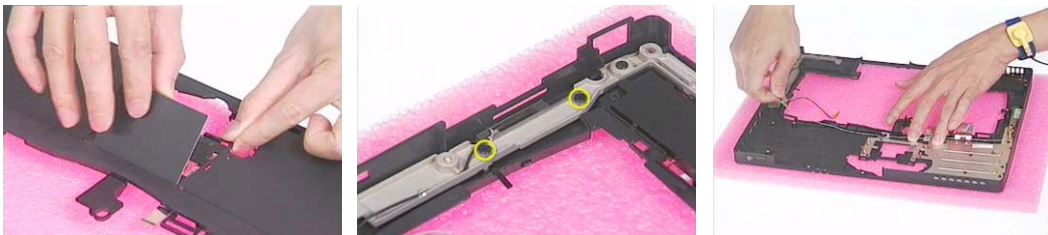

Disassembling the LCD Module

1. Remove the four screwpad then unscrew the four screws on the LCD bezel.
2. Detach the LCD bezel from the lower side of the LCD module carefully..



3. Unscrew the screw that holds the LCD inverter.
4. Disconnect the inverter board.
5. Remove the inverter wire.

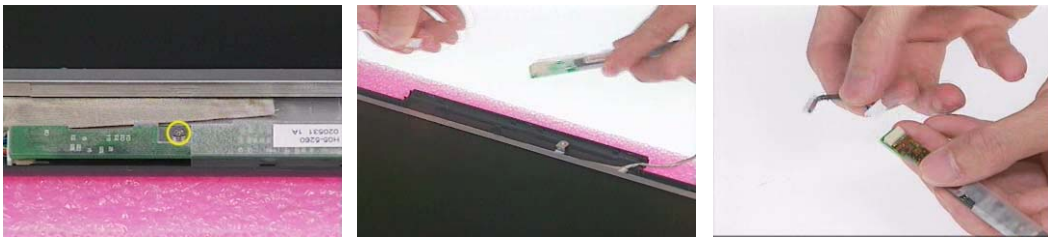

6. Unscrew the four screws that fasten the LCD to LCD panel. Two on each side.
7. Remove the LCD from the LCD panel.



8. Remove the four (two on each side) screws holding the two LCD brackets then take the brackets away.
9. Tear off the mylar that fastens the LCD coaxial cable.
10. Disconnect the LCD coaxial cable.



Disassembling the External Modules

Disassembling the HDD Module

1. Remove the screw holding the HDD cover.
2. Take the HDD out of the HDD cover.



3. Remove the four (two on each side) screws on HDD carrier.
4. Remove the HDD from HDD carrier.
5. Disconnect the HDD connector.



Disassembling the Optical Disk Drive Module/Combo Drive Module

1. Unscrew the two screws holding the ODD cover.
2. Remove another two screws that fasten the ODD cover.

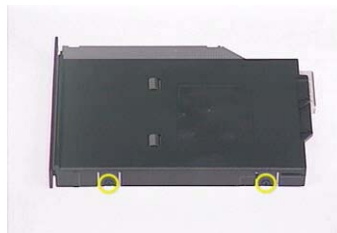
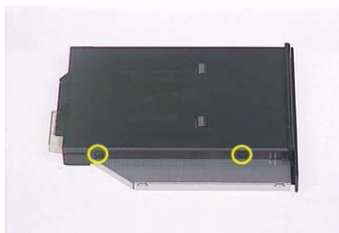

3. Take the ODD assembly out of the ODD cover.
4. Remove the two screws that secure the ODD PCB board.



5. Remove the ODD PCB board.
6. Release the ODD door latch on one side.
7. Then remove the ODD door carefully.



Troubleshooting

Use the following procedure as a guide for computer problems.

NOTE: The diagnostic tests are intended to test this model (TravelMate 430 series). Non-Acer products, prototype cards, or modified options can give false errors and invalid system responses.

1. Obtain the failed symptoms in as much detail as possible.
2. Verify the symptoms by attempting to re-create the failure by running the diagnostic test or by repeating the same operation.
3. If any problem occurs, you can perform visual inspection before you follow this chapter's instructions. You can check the following:
 - power cords are properly connected and secured;
 - there are no obvious shorts or opens;
 - there are no obviously burned or heated components;
 - all components appear normal.
4. After you perform visual inspection you can also verify the following:
 - ask the user if a password is registered and, if it is, ask him or her to enter the password.
 - verify with the customer that Windows XP is installed on the hard disk. Operating systems that were not preinstalled by Acer can cause malfunction.
 - make sure all optional equipment is removed from the computer.
 - make sure the floppy disk is empty.
5. Use the following table with the verified symptom to determine which page to go to.

Symptoms (Verified)	Go To
Power failure. (The power indicator does not go on or stay on.)	"Power System Check" on page 77.
POST does not complete. No beep or error codes are indicated.	"Power-On Self-Test (POST) Error Message" on page 81 "Undetermined Problems" on page 88
POST detects an error and displayed messages on screen.	"Error Message List" on page 82
The diagnostic test detected an error and displayed a FRU code.	"System Diagnostic Diskette" on page 50
Other symptoms (i.e. LCD display problems or others).	"Power-On Self-Test (POST) Error Message" on page 81
Symptoms cannot be re-created (intermittent problems).	Use the customer-reported symptoms and go to "Power-On Self-Test (POST) Error Message" on page 81 "Intermittent Problems" on page 87 "Undetermined Problems" on page 88

System Check Procedures

External Diskette Drive Check

Do the following steps to isolate the problem to a controller, driver, or diskette. A write-enabled, diagnostic diskette is required.

NOTE: Make sure that the diskette does not have more than one label attached to it. Multiple labels can cause damage to the drive or cause the drive to fail.

Do the following to select the test device. See “System Diagnostic Diskette” on page 50 for details.

1. The FDD heads can become dirty over time, affecting their performance. Use an FDD cleaning kit to clean the heads. If the FDD still does not function properly after cleaning, go to next step.
2. Boot from diagnostic program (see “System Diagnostic Diskette” on page 50)
3. If an error occurs with the internal diskette drive, reconnect the diskette connector on the main board.

If the error still remains:

1. Reconnect the external diskette drive module.
2. Replace the external diskette drive module.
3. Replace the main board.

External CD-ROM/DVD-ROM Drive Check

Do the following to isolate the problem to a controller, drive, or CD-ROM/DVD-ROM. Make sure that the CD-ROM does not have any label attached to it. The label can cause damage to the drive or can cause the drive to fail.

Do the following to select the test device:

1. Insert an audio CD into the CD/DVD drive. If the CD/DVD drive can read the data from the audio CD. The drive does not have problem, then go to next step. If the CD/DVD LED on the front panel does not emit light as it read the data from the audio CD, then go to next step. However, if the CD/DVD drive can not read data from the audio CD, you may need to clean the CD/DVD drive with a CD/DVD drive cleaning disk.
2. Make sure that the appropriate driver has been installed on the computer for the CD/DVD drive.
3. Boot from the diagnostics diskette and start the diagnostics program (refer to “System Diagnostic Diskette” on page 50.)
4. See if CD-ROM Test is passed when the program runs to CD-ROM/DVD-ROM Test.
5. Follow the instructions in the message window.

If an error occurs, reconnect the connector on the main board. If the error still remains:

1. Reconnect the CD-ROM/DVD-ROM module.
2. Replace the CD-ROM/DVD-ROM module.
3. Replace the main board.

Keyboard or Auxiliary Input Device Check

Remove the external keyboard if the internal keyboard is to be tested.

If the internal keyboard does not work or an unexpected character appears, make sure that the flexible cable extending from the keyboard is correctly seated in the connector on the main board.

If the keyboard cable connection is correct, run the Keyboard Test. See “System Diagnostic Diskette” on page 50 for more details.

If the tests detect a keyboard problem, do the following one at a time to correct the problem. Do not replace a non-defective FRU:

1. Reconnect the keyboard cables.
2. Replace the keyboard.
3. Replace the main board.

The following auxiliary input devices are supported by this computer:

- Embedded Numeric Keypad
- External keyboard

If any of these devices do not work, reconnect the cable connector and repeat the failing operation.

Memory Check

Memory errors might stop system operations, show error messages on the screen, or hang the system. Currently, we do not provide memory test program. However, if you need to check memory but have no testing program or diagnostic utility at hand, please go to <http://www.passmark.com> to download the shareware “BurnIn Test V.3.0”. You may test the memory with this program under Window XP environment.

NOTE: Make sure that the DIMM is fully installed into the connector. A loose connection can cause an error.

Power System Check

To verify the symptom of the problem, power on the computer using each of the following power sources:

1. Remove the battery pack.
2. Connect the power adapter and check that power is supplied.
3. Disconnect the power adapter and install the charged battery pack; then check that power is supplied by the battery pack.

If you suspect a power problem, see the appropriate power supply check in the following list:

- “Check the Power Adapter” on page 78
- “Check the Battery Pack” on page 79

Check the Power Adapter

Unplug the power adapter cable from the computer and measure the output voltage at the plug of the power adapter cable. See the following figure

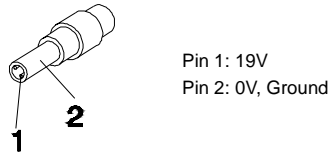

1. If the voltage is not correct, replace the power adapter.
2. If the voltage is within the range, do the following:
 - Replace the main board.
 - If the problem is not corrected, see “Undetermined Problems” on page 88.
 - If the voltage is not correct, go to the next step.

NOTE: An audible noise from the power adapter does not always indicate a defect.

3. If the DC-IN indicator does not light up, check the power cord of the power adapter for correct continuity and installation.
4. If the operational charge does not work, see “Check the Power Adapter” on page 78.

Check the Battery Pack

To check the battery pack, do the following:

From Software:

1. Check out the Power Options in control Panel
2. In Power Meter, confirm that if the parameters shown in the screen for Current Power Source and Total Battery Power Remaining are correct.
3. Repeat the steps 1 and 2, for both battery and adapter.
4. This helps you identify first the problem is on recharging or discharging.

From Hardware:

1. Power off the computer.
2. Remove the battery pack and measure the voltage between battery terminals 1(+) and 6(ground).
3. If the voltage is still less than 7.5 Vdc after recharging, replace the battery.
4. If the voltage is within the normal range, run the diagnostic program.

To check the battery charge operation, use a discharged battery pack or a battery pack that has less than 50% of the total power remaining when installed in the computer.

If the battery status indicator does not light up, remove the battery pack and let it return to room temperature. Re-install the battery pack.

If the charge indicator still does not emit, replace the battery pack. If the charge indicator still does not light up, replace the DC/DC charger board.

Touchpad Check

If the touchpad doesn't work, do the following actions one at a time to correct the problem. Do not replace a non-defective FRU:

1. After rebooting, run Touch pad/PS2 Mode Driver.
2. Run utility with the PS/2 mouse function and check if the mouse is working.
3. If the PS/2 mouse does not work, then check if the main board to switch board FPC is connected well.
4. If the main board to switch board FPC is connected well, then check if the touch pad FPC connects to the main board properly.
5. If there is still an error after you have connected the touch pad FPC to the main board properly, then replace the touch pad or touch pad FPC. The touch pad or touch pad FPC may be damaged.
6. Replace switch board.
7. If the touch pad still does not work, then replace the FPC on Track Pad PCB.

After you use the touchpad, the pointer drifts on the screen for a short time. This self-acting pointer movement can occur when a slight, steady pressure is applied to the touchpad pointer. This symptom is not a hardware problem. No service actions are necessary if the pointer movement stops in a short period of time.

Display Check

1. Connect an external display to the computer's external monitor port, the boot the computer. The computer can automatically detect the external display. Press Fn+  to switch to the external display.
2. If the external display works fine, the internal LCD may be damaged. Then perform the following steps:

Make sure the DDRRAM module is seated properly. Then run the display test again. If the problem still exists, go to next step.

Replace the inverter board, then run the display test program again. If the problem still occurs, go on next step.

Replace the LCD module with a new one then run the display test again. If the problem still happens, continue next step.

Replace LCD/FL cable with a new one then execute the display diagnostic again. If the problem

still occurs, continue next step.

Replace the CPU with another of the same specifications. If the problems still occurs, go to next step.

The main board may be damaged. Replace main board.

3. If the external monitor has the same problem as the internal monitor, the main board may be damaged. Please insert the diagnostic disk and run the display test program and go through the sub-steps under step 2.

Sound Check

To determine if the computer's built-in speakers are functioning properly, perform the following steps. Before you start the steps below, adjust the speaker volume to an appropriate level.

1. Try different audio sources. For example, employ audio CD and digital music file to determine whether the fault is in the speaker system or not. If not all sources have sound problem, the problem is in the source devices. If all have the same problem, continue next step.
2. Connect a set of earphone or external speakers. If these devices work fine, go to next step. If not, then the main board may be defective or damaged. Replace the main board.
3. Follow the disassembling steps in Chapter 3. Ensure the speaker cable is firmly connected to the main board. If the speaker is still a malfunction, go on next step.
4. If the speakers do not sound properly, the speakers may be defective or damaged. Replace the speakers. If the problem still occurs, then replace the main board.

Power-On Self-Test (POST) Error Message

The POST error message index lists the error message and their possible causes. The most likely cause is listed first.

NOTE: Perform the FRU replacement or actions in the sequence shown in FRU/Action column, if the FRU replacement does not solve the problem, put the original part back in the computer. Do not replace a non-defective FRU.

This index can also help you determine the next possible FRU to be replaced when servicing a computer.

If the symptom is not listed, see “Undetermined Problems” on page 88.

The following lists the error messages that the BIOS displays on the screen and the error symptoms classified by function.

NOTE: Most of the error messages occur during POST. Some of them display information about a hardware device, e.g., the amount of memory installed. Others may indicate a problem with a device, such as the way it has been configured.

NOTE: If the system fails after you make changes in the BIOS Setup Utility menus, reset the computer, enter Setup and install Setup defaults or correct the error.

Index of Error Messages

Error Message List

Error Messages	FRU/Action in Sequence
0200 Failure Fixed Disk	Hard disk error detected. Check to see if fixed disk is attached properly. Enter the BIOS Setup Utility and verify the hard disk is detected.
0210 Stucky Key	A key is stuck during keyboard initial. Please restart your system without pressing any keys.
0211 Keyboard error	see "Keyboard or Auxiliary Input Device Check" on page 77.
0212 Keyboard Controller Failed	see "Keyboard or Auxiliary Input Device Check" on page 77. May require replacing the keyboard controller.
0213Keyboard locked - Unlock key switch	Unlock the system to proceed.
0220 Monitor type does not match CMOS - Run SETUP	Display device mismatch. Enter the BIOS Setup Utility and verify the parameters (try loading the default settings); then save and restart the computer.
0230 System RAM Failed at offset: nnnn	Shadow RAM test failed Main board
0231 Shadow RAM Failed at offset: nnnn	System RAM test failed Main board
0232 Extended RAM Failed at address line: nnnn	Extended RAM test failed Main board
0250 System battery is dead - Replace and run SETUP	CMOS clock battery needs to be replaced. Replace the battery and run BIOS Setup Utility to reconfigure system time, then reboot system.
0251 System CMOS checksum bad - Default configuration used	CMOS data lost caused CMOS checksum failed. Default CMOS is being restored to allow system runs correctly. Enter Setup to customize the settings.
0252 Password checksum bad- Password cleared	Password checksum bad caused by CMOS lost. Please enter Setup to set your Password again.
0260 System timer error	System timer test failed, and the main board needs to be repaired. Run BIOS Setup Utility to reconfigure system time, then reboot system. Main board
0270 Real time clock error	RTC battery Run BIOS Setup Utility to reconfigure system time, then reboot system. Main board
0271 Check date and time settings	RTC time lost. Enter Setup to set the correct date and time.
0280 Previous boot incomplete - Default configuration used	Previous boot-up was not completed successfully. Enter the BIOS Setup Utility and verify the parameters (try loading the default settings); then save and restart the computer. RTC battery Main board
0281 Memory size found by POST differed from EISA CMOS	Run "Load Setup Defaults" in BIOS Setup Utility. Main board
02B0 Diskette drive A error	Drive A: is present but fails the BIOS POST diskette tests. Check the drive is defined with the proper diskette type in BIOS Setup Utility Check if the diskette drive is attached correctly. See "External Diskette Drive Check" on page 76.

Error Message List

Error Messages	FRU/Action in Sequence
02B1 Diskette drive B error	Drive B: is present but fails the BIOS POST diskette tests. Check the drive is defined with the proper diskette type in BIOS Setup Utility Check if the diskette drive is attached correctly. See "External Diskette Drive Check" on page 76.
02B2 Incorrect Drive A type - run SETUP	Type of floppy drive A: not correctly identified in Setup. Main board
02B2 Incorrect Drive B type - run SETUP	Type of floppy drive B: not correctly identified in Setup. Main board
02D0 System cache error - Cache disabled	RAM cache failed and BIOS disabled the cache. On older boards, check the cache jumpers. You may have to replace the cache. Main board
02F0 CPU ID	CPU socket number for Multi-Processor error. Main board
02F4 EISA CMOS not writeable	System unable to write to EISA CMOS. Main board
02F5 DMA Test Failed	System unable to write to DMA (Direct Memory Access) registers. Main board
02F6 Software NMI Failed	System unable to generate software NMI (Non-Maskable Interrupt). Main board
02F7 Fail-Safe Timer NMI Failed	Fail-Safe Timer takes too long. Main board
Invalid System Configuration Data	Error with NVRAM (CMOS) data. Enter the BIOS Setup Utility and verify the parameters (try loading the default settings); then save and restart your computer. Main board
Operating system not found	Operating system cannot be found on the boot device. Enter the BIOS Setup Utility and verify the parameters (try loading the default settings); then save and restart the computer. Recover hard disk. Reinstall the operating system.
Parity Check 1 <i>nnnn</i>	Parity error found on system bus. BIOS attempts to locate the address and display it on the screen. If it cannot locate the address, it displays.
Parity Check 2 <i>nnnn</i>	Parity error found on I/O bus. BIOS attempts to locate the address and display it on the screen. If it cannot locate the address, it displays .

Index of Symptom-to-FRU Error Message

LCD-Related Symptoms

Symptom / Error	Action in Sequence
LCD backlight doesn't work LCD is too dark LCD brightness cannot be adjusted LCD contrast cannot be adjusted	Enter BIOS Utility to execute "Load Setup Defaults" on Exit screen, then reboot system. Reconnect the LCD connectors. Keyboard (if contrast and brightness function key doesn't work). LCD cable LCD inverter LCD Main board
Unreadable LCD screen Missing pels in characters Abnormal screen Wrong color displayed	Reconnect the LCD connector LCD cable LCD inverter LCD Main board
LCD has extra horizontal or vertical lines displayed.	LCD inverter LCD cable LCD Main board

Indicator-Related Symptoms

Symptom / Error	Action in Sequence
Indicator incorrectly remains off or on, but system runs correctly	Reconnect the inverter board Inverter board Main board

Power-Related Symptoms

Symptom / Error	Action in Sequence
Power shuts down during operation	Power source (battery pack and power adapter). See "Power System Check" on page 77. Battery pack Power adapter Hard drive & battery connection board Main board
The system doesn't power-on.	Power source (battery pack and power adapter). See "Power System Check" on page 77. Battery pack Power adapter Hard drive & battery connection board Main board
The system doesn't power-off.	Power source (battery pack and power adapter). See "Power System Check" on page 77. Hold and press the power switch for more than 4 seconds. Main board
Battery can't be charged	See "Check the Power Adapter" on page 78. Battery pack Main board

PCMCIA-Related Symptoms

Symptom / Error	Action in Sequence
System cannot detect the PC Card (PCMCIA)	See "System Diagnostic Diskette" on page 50. Please run Sycard 32 Bit test. PCMCIA slot assembly Main board
PCMCIA slot pin is damaged.	PCMCIA slot assembly

Memory-Related Symptoms

Symptom / Error	Action in Sequence
Memory count (size) appears different from actual size.	DIMM Main board

Speaker-Related Symptoms

Symptom / Error	Action in Sequence
In Windows, multimedia programs, no sound comes from the computer.	See "Sound Check" on page 80 Audio driver Speaker Main board
Internal speakers make noise or emit no sound.	See "Sound Check" on page 80 Speaker Main board

Power Management-Related Symptoms

Symptom / Error	Action in Sequence
The system will not enter hibernation	Keyboard (if control is from the keyboard) Hard disk drive Main board
The system doesn't enter hibernation mode and four short beeps every minute.	Press Fn+F4 and see if the computer enters hibernation mode. Touchpad Keyboard Hard disk connection board Hard disk drive Main board
The system doesn't enter standby mode after closing the LCD	LCD cover switch Main board
The system doesn't resume from hibernation mode.	Hard disk connection board Hard disk drive Main board
The system doesn't resume from standby mode after opening the LCD.	LCD cover switch Main board
Battery fuel gauge in Windows doesn't go higher than 90%.	Remove battery pack and let it cool for 2 hours. Refresh battery (continue use battery until power off, then charge battery). Battery pack Main board
System hangs intermittently.	Reconnect hard disk drives. Hard disk drive connector Main board

Peripheral-Related Symptoms

Symptom / Error	Action in Sequence
System configuration does not match the installed devices.	Enter BIOS Setup Utility to execute "Load Setup defaults", then reboot system. Reconnect hard disk/CD-ROM/diskette drives.
External display does not work correctly.	See "System Diagnostic Diskette" on page 50 See if there is an error beep. If there is an error beep, then change main board. Power off. Then check if RAM CPU BIOS are well-connected. Press Fn+F5 three times slowly LCD FPC LCD inverter LCD
USB does not work correctly	USB device cable is firmly connected into the USB ports. Test one USB port each time. USB socket is firmly secured to the main board. Main board
Print problems.	Ensure the "Parallel Port" in the "System Devices" of BIOS Setup Utility is set to Enabled. Onboard Devices Configuration Run parallel port test Printer driver Printer cable Printer Main board

Keyboard/Touchpad-Related Symptoms

Symptom / Error	Action in Sequence
Keyboard (one or more keys) does not work.	Reconnect the keyboard cable. Keyboard Main board
Touchpad does not work.	Reconnect touch pad cable. Modem port is secured to the main board Touch pad FPC Audio/Touch pad board Main board

Modem-Related Symptoms

Symptom / Error	Action in Sequence
Internal modem does not work correctly.	Ensure the telephone cable is firmly plugged into the telephone wall socket and the modem port of the computer. Modem phone port is secured to the main board. modem combo board Main board

NOTE: If you cannot find a symptom or an error in this list and the problem remains, see "Undetermined Problems" on page 88.

Intermittent Problems

Intermittent system hang problems can be caused by a variety of reasons that have nothing to do with a hardware defect, such as: cosmic radiation, electrostatic discharge, or software errors. FRU replacement should be considered only when a recurring problem exists.

When analyzing an intermittent problem, do the following:

1. Run the diagnostic test for several times to isolate the problem.
2. If no error is detected, do not replace any FRU.
3. If any error is detected, replace the FRU. Rerun the test to verify that there are no more errors.

If an error is detected by the main battery test, see “Check the Power Adapter” on page 78

If an error is detected by the display test, see “Index of Symptom-to-FRU Error Message” on page 84 .

If an error is detected by the floppy disk drive test, see “External Diskette Drive Check” on page 76.

If an error is detected by the keyboard test, see “Keyboard or Auxiliary Input Device Check” on page 77.

Undetermined Problems

The diagnostic problems does not identify which adapter or device failed, which installed devices are incorrect, whether a short circuit is suspected, or whether the system is inoperative.

Follow these procedures to isolate the failing FRU (do not isolate non-defective FRU).

NOTE: Verify that all attached devices are supported by the computer.

NOTE: Verify that the power supply being used at the time of the failure is operating correctly. (See “Power System Check” on page 77):

1. Power-off the computer.
2. Visually check them for damage. If any problems are found, replace the FRU.
3. Remove or disconnect all of the following devices:
 - Non-Acer devices
 - Printer, mouse, and other external devices
 - Battery pack
 - Hard disk drive
 - DIMM
 - CD-ROM/Diskette drive Module
 - PC Cards
4. Power-on the computer.
5. Determine if the problem has changed.
6. If the problem does not recur, reconnect the removed devices one at a time until you find the failing FRU.
7. If the problem remains, replace the following FRU one at a time. Do not replace a non-defective FRU:
 - Main board
 - LCD assembly

POST Task Routines

Code	Beeps	POST Routine Description
02h		Verify Real Mode
03h		Disable Non-Maskable Interrupt (NMI)
04h		Get CPU type
06h		Initialize system hardware
08h		Initialize chipset with initial POST values
09h		Set IN POST flag
0Ah		Initialize CPU registers
0Bh		Enable CPU cache
0Ch		Initialize caches to initial POST values
0Eh		Initialize I/O component
0Fh		Initialize the local bus IDE
10h		Initialize Power Management
11h		Load alternate registers with initial POST values
12h		Restore CPU control word during warm boot
13h		Initialize PCI Bus Mastering devices
14h		Initialize keyboard controller
16h	1-2-2-3	BIOS ROM checksum
17h		Initialize cache before memory autosize
18h		8254 timer initialization
1Ah		8237 DMA controller initialization
1Ch		Reset Programmable Interrupt Controller
20h	1-3-1-1	Test DRAM refresh
22h	1-3-1-3	Test 8742 Keyboard Controller
24h		Set ES segment register to 4 GB
26h		Enable A20 line
28h		Autosize DRAM
29h		Initialize POST Memory Manager
2Ah		Clear 215 KB base RAM
2Ch	1-3-4-1	RAM failure on address line xxxx
2Eh	1-3-4-3	RAM failure on data bits xxxx of low byte of memory bus
2Fh		Enable cache before system BIOS shadow
30h	1-4-1-1	RAM failure on data bits xxxx of high byte of memory bus
32h		Test CPU bus-clock frequency
33h		Initialize Phoenix Dispatch Manager
36h		Warm start shut down
38h		Shadow system BIOS ROM
3Ah		Autosize cache
3Ch		Advanced configuration of chipset registers
3Dh		Load alternate registers with CMOS values
42h		Initialize interrupt vectors
45h		POST device initialization
46h	2-1-2-3	Check ROM copyright notice

Code	Beeps	POST Routine Description
48h		Check video configuration against CMOS
49h		Initialize PCI bus and devices
4Ah		Initialize all video adapters in system
4Bh		QuietBoot start (optional)
4Ch		Shadow video BIOS ROM
4Eh		Display BIOS copyright notice
50h		Display CPU type and speed
51h		Initialize EISA board
52h		Test keyboard
54h		Set key click if enabled
58h	2-2-3-1	Test for unexpected interrupts
59h		Initialize POST display service
5Ah		Display prompt "Press F2 to enter SETUP"
5Bh		Disable CPU cache
5Ch		Test RAM between 512 and 640 KB
60h		Test extended memory
62h		Test extended memory address lines
64h		Jump to User Patch1
66h		Configure advanced cache registers
67h		Initialize Multi Processor APIC
68h		Enable external and CPU caches
69h		Setup System Management Mode (SMM) area
6Ah		Display external L2 cache size
6Bh		Load custom defaults (optional)
6Ch		Display shadow-area message
6Eh		Display possible high address for UMB recovery
70h		Display error messages
72h		Check for configuration errors
76h		Check for keyboard errors
7Ch		Set up hardware interrupt vectors
7Eh		Initialize coprocessor if present
80h		Disable onboard Super I/O ports and IRQs
81h		Late POST device initialization
82h		Detect and install external RS232 ports
83h		Configure non-MCD IDE controllers
84h		Detect and install external parallel ports
85h		Initialize PC-compatible PnP ISA devices
86h		Re-initialize onboard I/O ports
87h		Configure Motherboard Configurable Devices (optional)
88h		Initialize BIOS Area
89h		Enable Non-Maskable Interrupts (NMIs)
8Ah		Initialize Extended BIOS Data Area
8Bh		Test and initialize PS/2 mouse
8Ch		Initialize floppy controller

Code	Beeps	POST Routine Description
8Fh		Determine number of ATA drives (optional)
90h		Initialize hard-disk controllers
91h		Initialize local-bus hard-disk controllers
92h		Jump to UserPatch2
93h		Build MPTABLE for multi-processor boards
95h		Install CD ROM for boot
96h		Clear huge ES segment register
97h		Fixup Multi Processor table
98h	1-2	Search for option ROMs. One long, two short beeps on checksum failure.
99h		Check for SMART drive (optional)
9Ah		Shadow option ROMs
9Ch		Set up Power Management
9Dh		Initialize security engine (optional)
9Eh		Enable hardware interrupts
9Fh		Determine number of ATA and SCSI drives
A0h		Set time of day
A2h		Check key lock
A4h		Initialize Typematic rate
A8h		Erase F2 prompt
AAh		Scan for F2 key stroke
ACh		Enter SETUP
A Eh		Clear Boot flag
B0h		Check for errors
B2h		POST done- prepare to boot operating system
B4h	1	One short beep before boot
B5h		Terminate QuietBoot (optional)
B6h		Check password (optional)
B9h		Prepare Boot
BAh		Initialize DMI parameters
BBh		Initialize PnP Option ROMs
BCh		Clear parity checkers
BDh		Display MultiBoot menu
BEh		Clear screen (optional)
BFh		Check virus and backup reminders
C0h		Try to boot with INT 19
C1h		Initialize POST Error Manager (PEM)
C2h		Initialize error logging
C3h		Initialize error display function
C4h		Initialize system error handler
C5h		PnPnd dual CMOS (optional)
C6h		Initialize notebook docking (optional)
C7h		Initialize notebook docking late
C8h		Force check (optional)
C9h		Extended checksum (optional)
D2h		Unknown interrupt

Code	Beeps	For Boot Block in Flash ROM
E0h		Initialize the chipset
E1h		Initialize the bridge
E2h		Initialize the CPU
E3h		Initialize the system timer
E4h		Initialize system I/O
E5h		Check force recovery boot
E6h		Checksum BIOS ROM
E7h		Go to BIOS
E8h		Set Huge Segment
E9h		Initialize Multi Processor
EAh		Initialize OEM special code
EBh		Initialize PIC and DMA
ECh		Initialize Memory type
EDh		Initialize Memory size
EEh		Shadow Boot Block
EFh		System memory test
F0h		Initialize interrupt vectors
F1h		Initialize Run Time Clock
F2h		Initialize video
F3h		Initialize System Management Mode
F4h	1	Output one beep before boot
F5h		Boot to Mini DOS
F6h		Clear Huge Segment
F7h		Boot to Full DOS

Index of Flash BIOS Error Message

Index of flashing BIOS Error Message using PHLASH.EXE.

Error Message	Action in Sequence
BIOS backup not supported in PLATFORM.BIN	Current Platform.bin does not support BIOS backup. Please contact your vendor for latest platform.bin or remove BIOS backup
File Open/Read/Close failed on PLATFORM.BIN	Make sure that PLATFORM.BIN files is present and not damaged. Also check if there is enough space for rewriting.
Unsupported PLATFORM.BIN file version	Make sure the platform.bin is the correct version.
Device table in PLATFORM.BIN has unsupported flash type	Current Flash ROM part is not supported in this platform.bin
Part ID not found in table of supported parts	Current Flash ROM part is not supported in this platform.bin
Open/Read failed on BIOS ROM image file	Make sure the BIOS ROM image is present, and not damaged. Copy BIOS ROM again.
File Close failed on BIOS.ROM	Make sure the BIOS ROM image is present, and not damaged. Copy BIOS ROM again.
Cannot flash when Memory Managers (e.g. EMM386) are present	Please boot to pure DOS without EMM386 is present in order to flash BIOS.
Attempt to read flash memory ID failed	System cannot read its Flash Part ID, please try again. If problem appears after second try, please contact your vendor.
File does not contain the same BIOS part number	Make sure the BIOS ROM is for your platform.
Write/Erase to flash memory failed	During Flashing Process, writing and erasing memory failed. Make sure the ROM part that you flash is not damaged.
New DMI string is too large	Please add/mode=3 parameter after phlash.exe to flash DMI data structures.
Could not find BCPDMI block in BISO ROM file image	Remove d/mode=3 parameter after phlash.exe because there is no DMI structure present in your BIOS images.
Cannot flash when Memory Managers (e.g. HIMEM) are present	Please boot to a pure DOS without HIMEM.sys installed before you flash BIOS.
BIOS ROM file may be corrupt (checksum not zero)	Make sure the BIOS ROM is not damaged.
BIOS ROM file size does not match flash part size	Make sure the BIO ROM is not damaged and its size is the same as Flash part size.
RTC does not present or does not function- can't flash	RTC is probably damaged. Check RTC battery and RTC time.

Jumper and Connector Locations

Top View

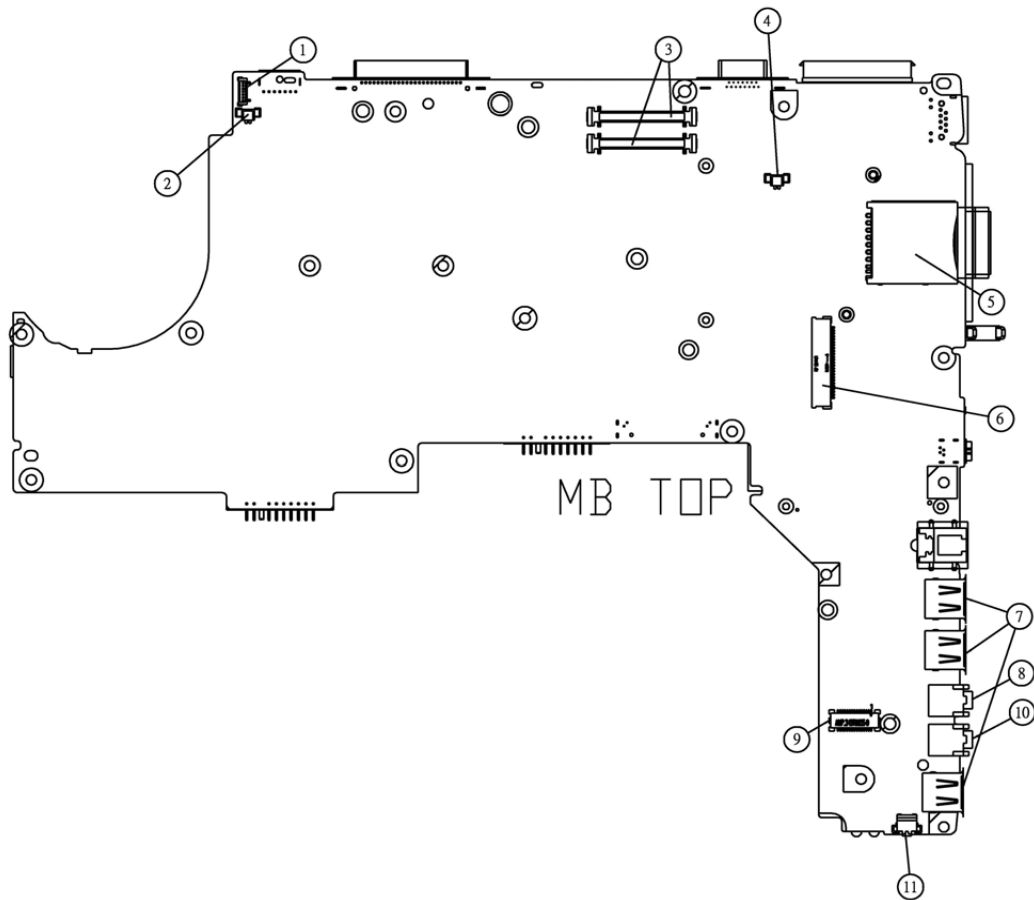

1-JP1	Inverter Connector	7-JP10, JP11 and JP15	USB Connector
2-JP2	Speaker L Connector	8-JP12	Headphone Out Jack
3-JP3 and JP5	VGA Board to Main Board Connector	9-JP13	MDC Connector
4-JP6	Speaker R Connector	10-JP14	Ext. MIC In Jack
5-JP7	SD/MMC Socket	11-SW1	Wireless Networking Bottom
6-JP8	Int. Keyboard Connector		

SW1 Settings (Lid switch)

	Setting
Function 1	NONE
Function 2	STAND BY
Function 3	HIBERNATE

SW2 Settings

SW2	Setting
POWER BUTTON	ON:SYSTEM ON OFF: SYSTEM OFF

Bottom View

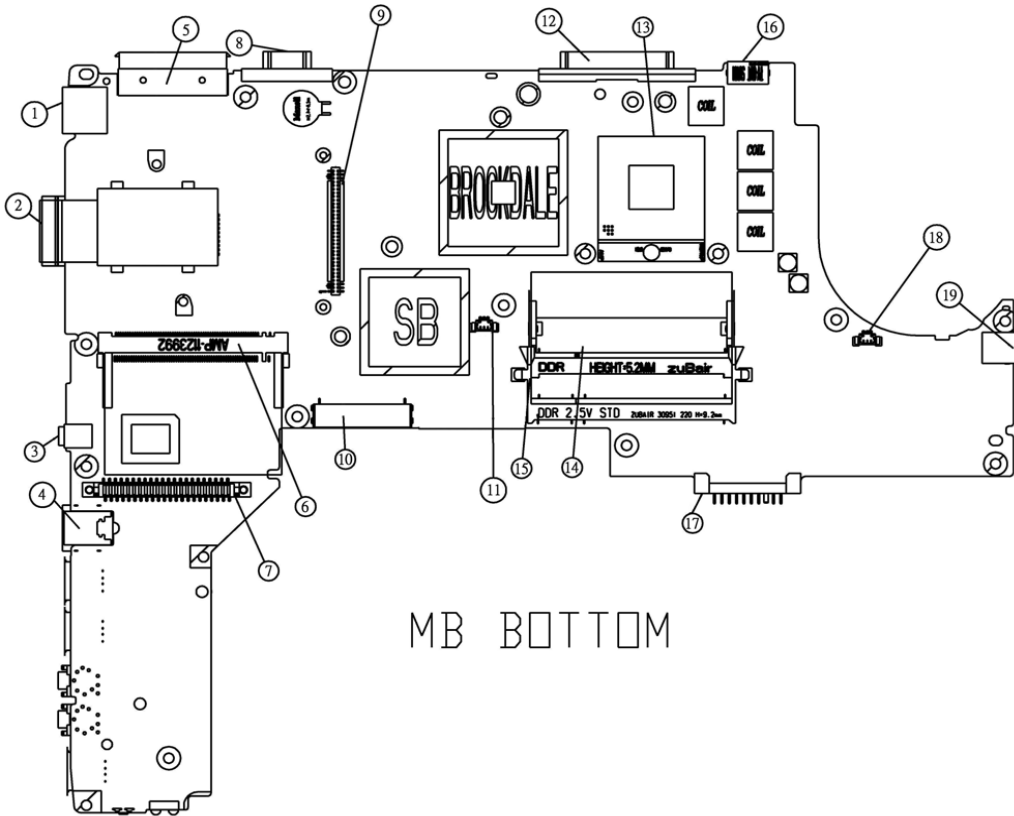

1-JP21	RJ45	11-JP25	2nd Fan Connector
2-JP23	Memory Stick Socket	12-JP16	Parallel Port
3-JP33	1394 Connector	13-U32	CPU Socket
4-JP35	RJ11	14-JP29	SO-DIMM Socket (H: 5.2mm)
5-JP22	SPR Connector	15-JP32	SO-DIMM Socket (H: 9.2mm)
6-JP27	Mini PCI Socket	16-JP20	S-Video Connector
7-JP34	HDD Connector	17-PCN2	Battery Connector
8-JP19	CRT Connector	18-JP26	Main Fan Connector
9-JP24	PCMCIA Connector	19-PCN1	DC-In Jack
10-JP31	Module Bay Connector		

FRU (Field Replaceable Unit) List

This chapter gives you the FRU (Field Replaceable Unit) listing in global configurations of TravelMate 420 series products. Refer to this chapter whenever ordering for parts to repair or for RMA (Return Merchandise Authorization).

Please note that WHEN ORDERING FRU PARTS, you should check the most up-to-date information available on your regional web or channel. For whatever reasons a part number change is made, it will not be noted on the printed Service Guide. For ACER AUTHORIZED SERVICE PROVIDERS, your Acer office may have a DIFFERENT part number code from those given in the FRU list of this printed Service Guide. You MUST use the local FRU list provided by your regional Acer office to order FRU parts for repair and service of customer machines.

NOTE: To scrap or to return the defective parts, you should follow the local government ordinance or regulations on how to dispose it properly, or follow the rules set by your regional Acer office on how to return it.

Exploded Diagram

THE SYSTEM

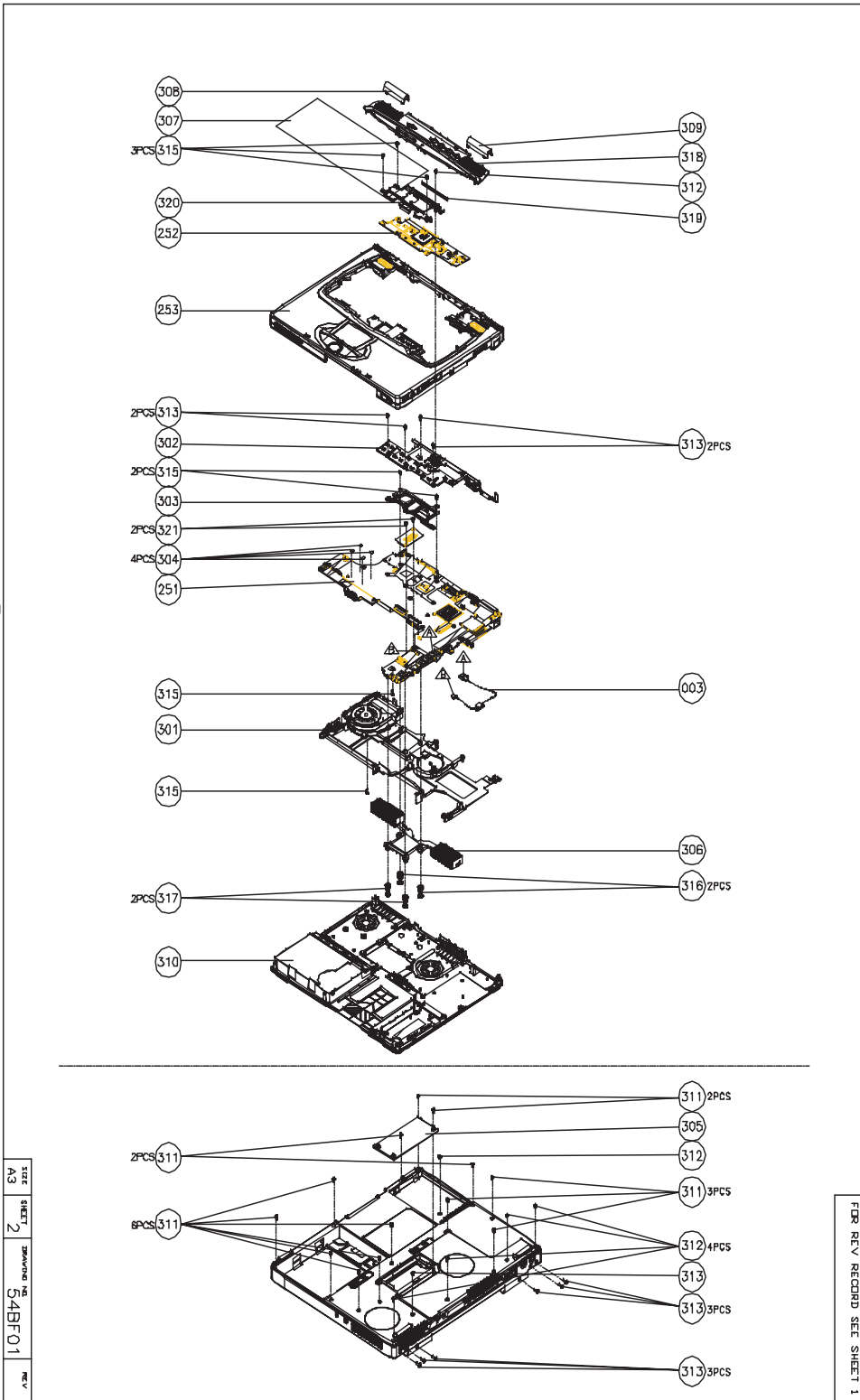

LOGIC UP ASSY

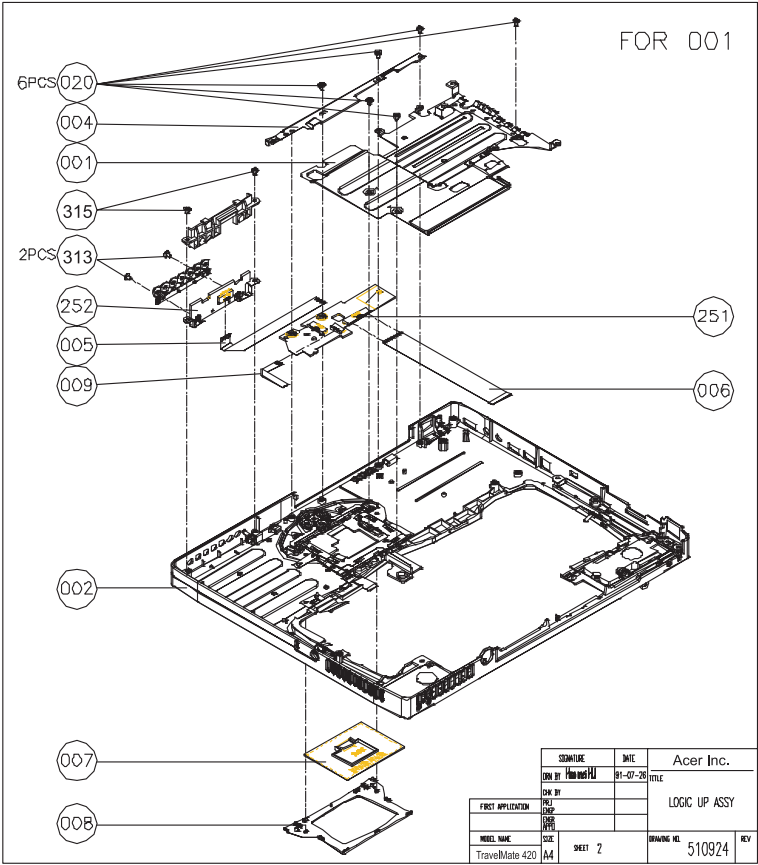

LOGIC UP ASSY (Wireless)

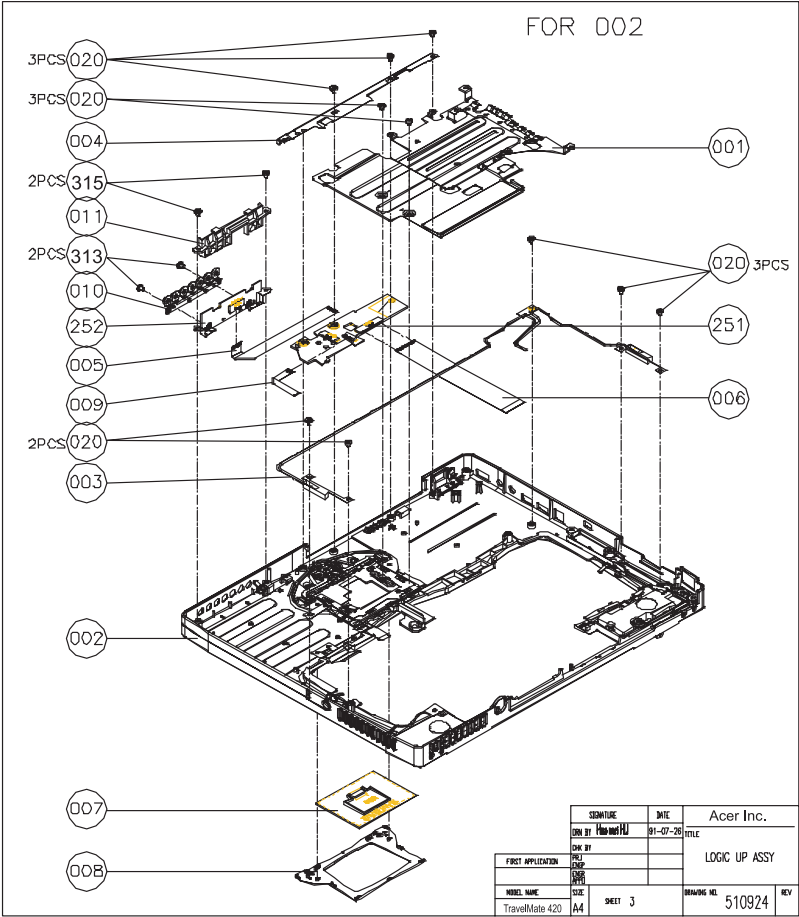

SIGNATURE		DATE	Acer Inc.	
BY: <i>[Signature]</i>		01-07-06	TITLE	
FIRST APPLICATION	PC		LOGIC UP ASSY	
	DEPT			
MODEL NAME	FILE	SHEET 3	DRAWING NO.	REV
TravelMate 420	AA		510924	

LCD 14.1"

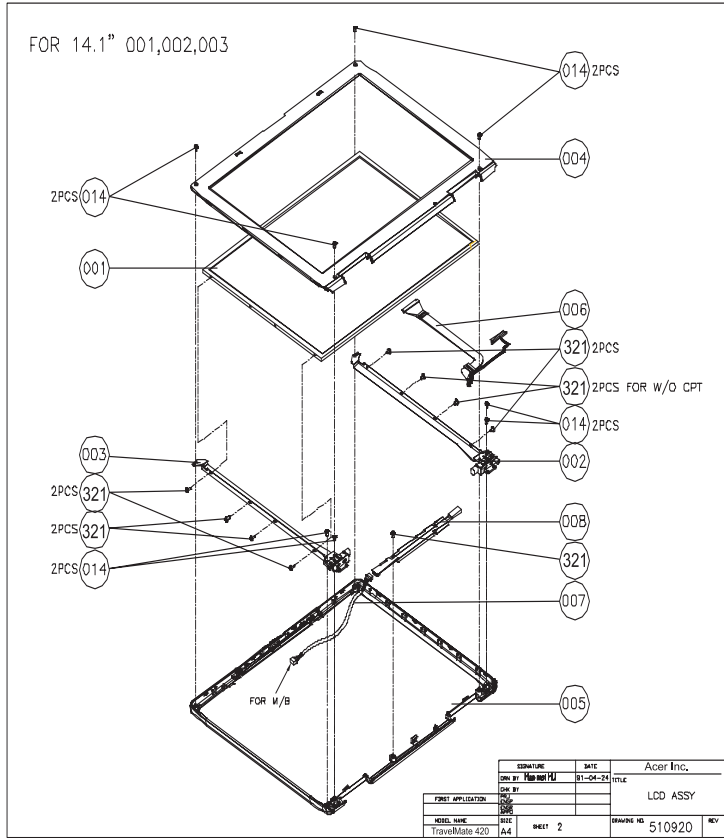

LCD 15"

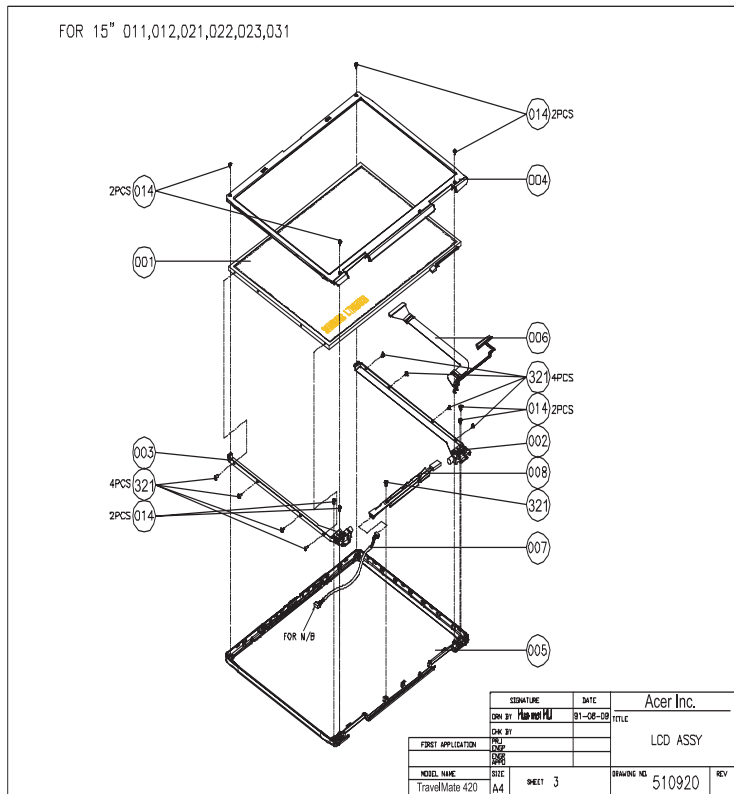

DVD ASSY

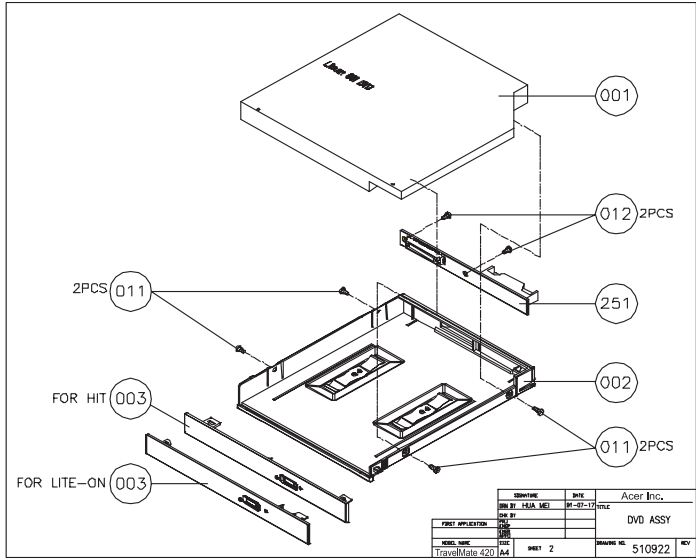



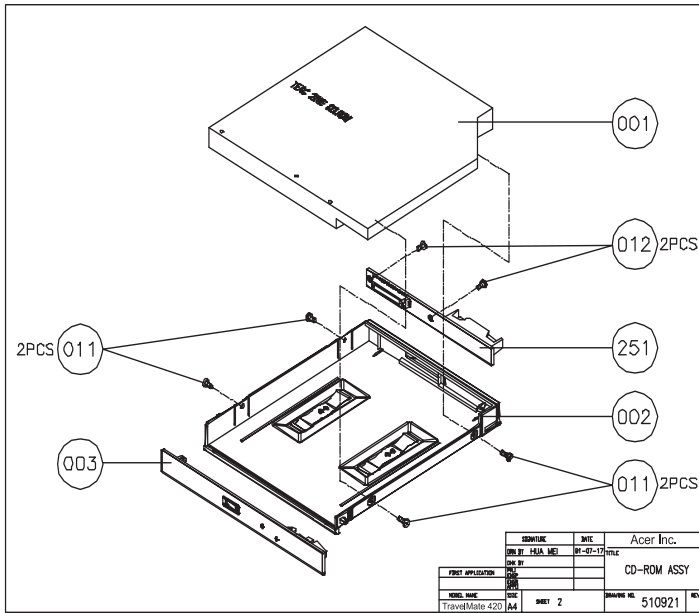

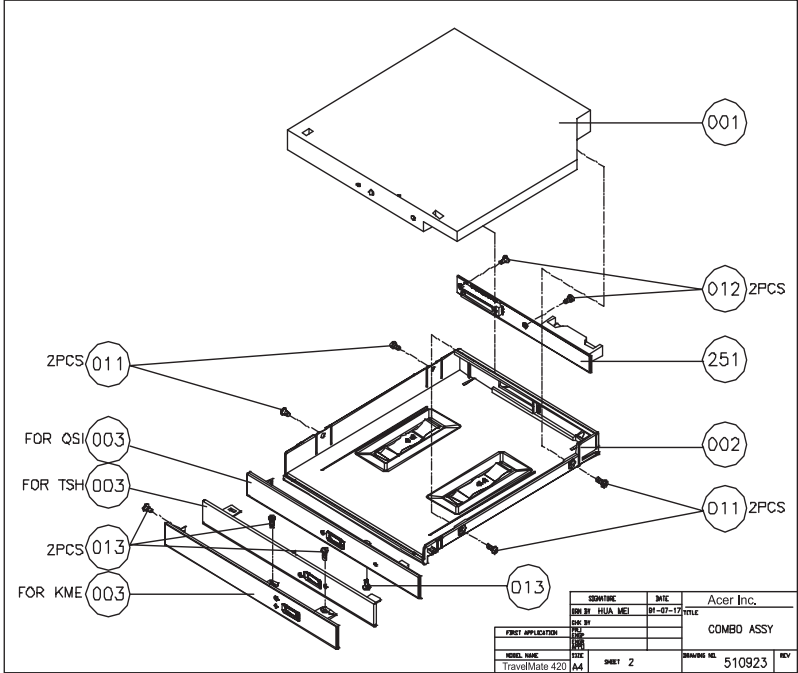

CD-ROM ASSY



Combo ASSY









Picture	No.	Partname And Description	Part Number
Adapter			
	NS	ADAPTER - API 90W (3 PIN) / 4.74AMP/ API2AD02-381	AP.T2602.001
		ADAPTER - LITEON 90W (3 PIN) / 4.74AMP/PA- 1900-05CA	AP.T1903.001
Battery			
	NS	ADAPTER - LITEON 90W (3 PIN) / 4.74AMP/PA- 1900-05CA	BT.T2603.001
		BATTERY LI-ION 9 CELLS-SONY 2100mAH (2100mAH/69.3Wh/ LIP9100CMPT/TW)	BT.T2604.001
Boards			
	252-THE SYSTEM	BOARD-VGA BOARD	55.T26V5.001
	252-LOGIC UP ASSY AND LOGIC UP ASSY(WIRE LESS)	BOARD-CD PLAYER BOARD	55.T19V5.002
	251-LOGIC UP ASSY AND LOGIC UP ASSY(WIRE LESS)	BOARD-TOUCHPAD BUTTON BOARD	56.T19V5.001
	007-LOGIC UP ASSY AND LOGIC UP ASSY(WIRE LESS)	BOARD-TOUCHPAD	56.T19V5.002
	NS	BOARD-MODEM BOARD AMBIT U98M005.05MDC SCOP101	54.T24V5.001
	NS	MODEM / BLUETOOTH COMBO BOARD AMBIT T60M665.00	54.T24V5.002

Picture	No.	Partname And Description	Part Number
	NS	BOARD-MINI PCI WIRELESS BOARD (802.11b) (WNC EM9-NB)	54.T26V5.003
		MINI PCI WIRELESS BOARD (802.11a+b) (WNC VM4-3B)	54.T26V5.004
Cables			
	006-LOGIC UP ASSY AND LOGIC UP ASSY(WIRELESS)	FFC-MB TO TOUCHPAD BUTTON BOARD	50.T19V5.001
	009-LOGIC UP ASSY AND LOGIC UP ASSY(WIRELESS)	FFC-TOUCHPAD BUTTON BOARD TO TOUCHPAD	50.T19V5.002
	005-LOGIC UP ASSY AND LOGIC UP ASSY(WIRELESS)	FFC-TOUCHPAD BUTTON BOARD TO CD PLAYER BOARD	50.T19V5.003
	003-THE SYSTEM	CABLE-MDC CARD	50.T19V5.004
		WIRELESS ANTENNA LINE	50.T26V5.001
		BLUETOOTH ANTENNA LINE	50.T26V5.002
	NS	POWER CORD US (3Pin)	27.T19V5.001
		POWER CORD EC (3Pin)	27.T19V5.002
		POWER CORD Aus (3Pin)	27.T19V5.003
		POWER CORD UK (3Pin)	27.T19V5.004
		POWER CORD SWISS (3Pin)	27.T19V5.005
		POWER CORD CHINA (3Pin)	27.T19V5.006
		POWER CORD ITALIAN (3Pin)	27.T19V5.007
		POWER CORD DEMARK (3Pin)	27.T19V5.008
Case/Cover/Bracket Assembly			
	318-THE SYSTEM	MIDDLE COVER W/ NAME PLATE	42.T26V5.001







Picture	No.	Partname And Description	Part Number
	310-THE SYSTEM	LOWER CASE	60.T26V5.001
	305-THE SYSTEM	DIMM COVER	42.T26V5.002
	253-THE SYSTEM	UPPER CASE (W/SPEAKERS AND HINGE SADDLE)	60.T26V5.002
	302-THE SYSTEM	I/O BRACKET	33.T26V5.001
	001-LOGIC UP ASSY AND LOGIC UP ASSY(WIRE LESS)	UPPER CASE SHIELDING	33.T19V5.002
	320-THE SYSTEM	VGA SHIELDING	33.T19V5.004
	010-LOGIC UP ASSY AND LOGIC UP ASSY(WIRE LESS)	CD-PLAYER BUTTON	42.T19V5.003
	011-LOGIC UP ASSY AND LOGIC UP ASSY(WIRE LESS)	CD-PLAYER SUPPORT	42.T19V5.004

Picture	No.	Partname And Description	Part Number
	008-LOGIC UP ASSY AND LOGIC UP ASSY(WIRE LESS)	TOUCHPAD COVER	42.T19V5.005
	309-THE SYSTEM	HINGE CAP-R	42.T19V5.006
	308-THE SYSTEM	HINGE CAP-L	42.T19V5.007
CPU			
	NS	Intel Pentium 4 2.26Ghz/512k/533FSB C-1	01.NORTH.2GB
		Intel Pentium 4 2.4Ghz/512k/533FSB C-1	01.NORTH.24A
		Intel Pentium 4 2.53Ghz/512k/533FSB C-1	01.NORTH.253
		Intel Pentium 4 2.66Ghz/512k/533FSB C-1	01.NORTH.266
		Intel Pentium 4 2.8Ghz/512k/533FSB C-1	01.NORTH.28C
		Intel Pentium 4 3.06Ghz/512k/533FSB C-1	01.NORTH.306
		Northwood 2.8GHz/512K/533FSB 1.475V	KC.DP101.28G
		Northwood 2.8GHz/512K/533FSB 1.5V	01.NORTH.2GB
FDD			
	NS	FDD MODULE	KF.T1903.001
	NS	FDD DRIVE NEC FD3238T-270	KF.32303.001
	NS	TM420 FDD FPC	50.T19V5.015

Picture	No.	Partname And Description	Part Number
	NS	TM420 FDD CASE	33.T19V5.021
	NS	TM420 FDD MYLAR	47.T19V5.004
	NS	TM 420FDD BACK COVER	33.T19V5.022
HDD/ Hard Disk Drive			
	NS	HDD 2.5" 20G HGST CASCADE IC25N020ATCS04-0 07N8325 FW: A71A	KH.02007.001
		HDD 2.5" 30G HGST CASCADE IC25N030ATCS04-0 07N8326 FW: A71A	KH.03007.001
		HDD 2.5" 40G HGST CASCADE IC25N040ATCS04-0 07N8326 FW: A71A	KH.04007.001
		HDD 2.5" 20G TOSHIBA TITAN MK2018GAP 4300RPM	KH.25204.001
		HDD 2.5" 30G TOSHIBA TITAN MK3018GAP 4300RPM	KH.25304.001
		HDD 2.5" 40G TOSHIBA TITAN MK4018GAP 4300RPM	KH.25404.001
		HDD 2.5" 30G TOSHIBA NEPTUNE MK3021GAS 4300RPM	KH.33004.001
		HDD 2.5" 40G TOSHIBA NEPTUNE MK3021GAS 4300RPM	KH.34004.001
		HDD 2.5" 60G TOSHIBA NEPTUNE MK6021GAS 4300RPM	KH.36004.001
		HDD 2.5" 20G Hitachi Eucalyptus DK23EA 4300RPM	KH.32005.002
		HDD 2.5" 30G Hitachi Eucalyptus DK23EA/-30 4300RPM	KH.33005.002
		HDD 2.5" 40G Hitachi Eucalyptus DK23EA/-40 4300RPM	KH.34005.002
		HDD 2.5" 60G Hitachi Eucalyptus DK23EA/-60 4300RPM	KH.06005.001
	NS	HDD CARRIER	33.T19V7.006
	NS	HDD CONNECTOR	22.T19V5.001

Picture	No.	Partname And Description	Part Number
	NS	HDD COVER	42.T19V5.008
Keyboard			
	NS	KEYBOARD DARFON ARABIC NSK-A680A 84KEYS	KB.T2607.010
		KEYBOARD DARFON BELGIUM NSK-A681A 85KEYS	KB.T2607.012
		KEYBOARD DARFON BRAZILIAN PORTUGUESE NSK-A681B 85KEYS	KB.T2607.020
		KEYBOARD DARFON CANADIAN FRENCH NSK-A680M 85KEYS	KB.T2607.019
		KEYBOARD DARFON CHINESE NSK-A6802 84KEYS	KB.T2607.005
		KEYBOARD DARFON CZECH NSK-A680C 85KEYS	KB.T2607.014
		KEYBOARD DARFON DANISH NSK-A680D 85KEYS	KB.T2607.017
		KEYBOARD DARFON FRENCH NSK-A680F 85KEYS	KB.T2607.006
		KEYBOARD DARFON GERMAN NSK-A680G 85KEYS	KB.T2607.003
		KEYBOARD DARFON HUNGAIAN NSK-A680Q 85KEYS	KB.T2607.015
		KEYBOARD DARFON ITALIAN NSK-A680E 85KEYS	KB.T2607.004
		KEYBOARD DARFON JAPAN NSK-A680J 86KEYS	KB.T2607.021
		KEYBOARD DARFON KOREA NSK-A680K 84KEYS	KB.T2607.022
		KEYBOARD DARFON NORWAY NSK-A680N 85KEYS	KB.T2607.016
		KEYBOARD DARFON PORTUGUESE NSK- A6806 85KEYS	KB.T2607.009
		KEYBOARD DARFON RUSSIAN NSK-A680P 85KEYS	KB.T2607.023
		KEYBOARD DARFON SPANISH NSK-A680S 85KEYS	KB.T2607.008
		KEYBOARD DARFON SWEDEN NSK-A680W 85KEYS	KB.T2607.013
		KEYBOARD DARFON SWISS/G NSK-A6800 85KEYS	KB.T2607.007
		KEYBOARD DARFON THAI NSK-A6803 84KEYS	KB.T2607.011
KEYBOARD DARFON TURKISH NSK-A680T 85KEYS	KB.T2607.018		
KEYBOARD DARFON UK NSK-A680U 85KEYS	KB.T2607.002		
KEYBOARD DARFON US INTERNATIONAL NSK-A681D 84KEYS	KB.T2607.001		

Picture	No.	Partname And Description	Part Number
LCD			
	LCD 14.1" AND LCD 15"	ASSY LCD MODULE 14.1" XGA CPT	6M.T19V5.011
		ASSY LCD MODULE 14.1" XGA AU (B141XN04) 5AXXX	6M.T26V5.012
		ASSY LCD MODULE 15" XGA CPT (CLAA150XH01)	6M.T26V5.011
		ASSY LCD MODULE 15.0" XGA AU	6M.T19V5.014
		ASSY LCD MODULE 15.0" XGA HANNSTAR	6M.T19V5.015
		ASSY LCD MODULE 15.0" SXGA+ AU	6M.T19V5.016
		ASSY LCD MODULE 15.0" SXGA+ IBM	6M.T19V5.017
		ASSY LCD MODULE 15.0" SXGA+ HITACHI	6M.T19V5.018
	001-LCD 14.1" AND LCD 15"	ASSY LCD 14.1" XGA CPT	LK.14109.002
		ASSY LCD 14.1" XGA AU (B141XN04) 5AXXX	LK.14105.002
		ASSY LCD 15" XGA CPT (CLAA150XH01)	LK.1500A.001
		ASSY LCD 15.0" XGA AU	LK.15005.001
		ASSY LCD 15.0" XGA HANNSTAR	LK.15007.001
		ASSY LCD 15.0" SXGA+ AU	LK.15005.002
		ASSY LCD 15.0" SXGA+ IBM	LK.15003.001
		ASSY LCD 15.0" SXGA+ HITACHI	LK.15004.002
	008-LCD 14.1" AND LCD 15"	LCD INVERTER	19.T19V5.001
	007-LCD 14.1" AND LCD 15"	LCD INVERTER CABLE	50.T19V5.001
	005-LCD 14.1" AND LCD 15"	LCD PANEL WITH LOGO	60.T19V5.003
	004-LCD 14.1" AND LCD 15"	LCD BEZEL-14.1"	60.T19V5.004
		LCD BEZEL-15.0"	60.T19V5.005

Picture	No.	Partname And Description	Part Number
	003-LCD 14.1" AND LCD 15"	LCD BRACKET L 14" CPT	33.T19V5.007
		LCD BRACKET L 14" AU	33.T19V5.009
		LCD BRACKET L 15" CPT	33.T26V5.002
		LCD BRACKET L 15" AU	33.T19V5.011
		LCD BRACKET L 15" HANNSTAR	33.T19V5.013
		LCD BRACKET L 15" SXGA AU	33.T19V5.015
		LCD BRACKET L 15" SXGA IBM	33.T19V5.017
		LCD BRACKET L 15" HITACHI	33.T19V5.019
	002-LCD 14.1" AND LCD 15"	LCD BRACKET R 14" CPT	33.T19V5.008
		LCD BRACKET R 14" AU	33.T19V5.010
		LCD BRACKET R 15" CPT	33.T26V5.003
		LCD BRACKET R 15" AU	33.T19V5.012
		LCD BRACKET R 15" HANNSTAR	33.T19V5.014
		LCD BRACKET R 15" SXGA AU	33.T19V5.016
		LCD BRACKET R 15" SXGA IBM	33.T19V5.018
		LCD BRACKET R 15" HITACHI	33.T19V5.020
	006-LCD 14.1" AND LCD 15"	LCD COAXIAL CABLE - 14.1" CPT	50.T19V5.007
		LCD COAXIAL CABLE - 14" AU (B141XN04)	50.T19V5.008
		LCD COAXIAL CABLE - 15" CPT	50.T26V5.003
		LCD COAXIAL CABLE - 15" AU	50.T19V5.010
		LCD COAXIAL CABLE - 15" HANNSTAR	50.T19V5.011
		LCD COAXIAL CABLE - 15" SXGA AU	50.T19V5.012
		LCD COAXIAL CABLE - 15" SXGA IBM	50.T19V5.013
		LCD COAXIAL CABLE - 15" SXGA HITACHI	50.T19V5.014
	NS	LCD RUBBER-TOP	47.T19V5.001
	NS	LCD RUBBER-LOW	47.T19V5.002
Main Board			
	251-THE SYSTEM	MAINBOARD W/ PCMCIA SLOT(W/O CPU, MEMORY)	MB.T2602.001
		PCMCIA SLOT	21.T26V5.001
Memory			

Picture	No.	Partname And Description	Part Number
	NS	INFINEON 128MB HYS64V16000GDL-7-B	KN.12802.004
		NANYA 128MB NT128D64SH4B0GM-75B (.14U)	KN.12803.006
		MICRON 128MB MT4VDDT1664HG-265C2(16MX16)	KN.12804.005
		INFINEON 256MB HYS64D32020GDL-7-B 32MX8*8 (.14U)	KN.25602.001
		ELPIDA 256MB W30256A6EPI652A	KN.25609.001
		NANYA 256MB NT256D64SH8B0GM-75B (.14U)	KN.25603.004
		MICRON 256MB MT8VDDT3264HDG-265C3(16MX16)	KN.25604.004
		INFINEON 512MB HYS64D64020GBDL-7-B 64MX64 (.14U)	KN.51202.003
		NANYA 512MB NT512D64S8HAKWM-7K(.175U) CL2	KN.51203.003
Optical Drive			
	DVD ASSY, CD-ROM ASSY AND COMBO ASSY	DVD-ROM MODULE 8X TOSHIBA (SR-C2612)	6M.T19V5.002
		DVD/RW COMBO MODULE 24X QSI (SBW242)	6M.T26V5.003
		DVD/RW COMBO MODULE 24X KME (UJDA740)	6M.T19V5.101
	001-DVD ASSY, CD-ROM ASSY AND COMBO ASSY	DVD-ROM DRIVE 8X TOSHIBA (SR-C2612)	KV.08X01.001
		DVD/RW COMBO DRIVE 24X QSI (SBW242)	KO.24X07.002
		DVD/RW COMBO DRIVE 24X KME (UJDA740)	KO.24X03.001
	003-DVD ASSY, CD-ROM ASSY AND COMBO ASSY	DVD-ROM BEZEL FOR 8X TOSHIBA	42.T19V5.012
		DVD/RW COMBO BEZEL FOR 24X QSI	42.T19V5.016
		DVD/RW COMBO BEZEL FOR KME	42.T19V5.017
	002-DVD ASSY, CD-ROM ASSY AND COMBO ASSY	ODD HOLDER	33.T19V5.005
	251-DVD ASSY, CD-ROM ASSY AND COMBO ASSY	ODD PCB	55.T19V5.003
Others			

Picture	No.	Partname And Description	Part Number
	THE SYSTEM	SPEAKER R (WITH SHORTER CABLE THNA THE LEFT SPEAKER)	23.T19V5.001
	THE SYSTEM	SPEAKER L	23.T19V5.002
	NS	VGA SHIELDING MYLAR	47.T19V5.003
	301-THE SYSTEM	MAIN FRAME W/FAN	6K.T26V5.001
	306-THE SYSTEM	THERMAL MODULE	6K.T26V5.002
Screws			
	315-THE SYSTEM	SCREW M2.5X0.45+4A-BNI	86.T19V5.002
	014-LCD 14.1" and LCD 15 313-THE SYSTEM"	SAFETY SCREW M2.5X0.45+6FP-ZK(NL)	86.T19V5.003
	312-THE SYSTEM	SCREW M2.5X0.45+10FP-ZK(NL)	86.T19V5.004
	311-THE SYSTEM	SCREW M2.5X0.45+16FP-ZK (NL)	86.T19V5.005
	012-CD-ROM ASSY, DVD ASSY and Combo ASSY	SCREW M2.0X4FP-ZK(H3.5-3.8XT0.6)	86.T19V5.006
	020-LOGIC UP ASSY AND LOGIC UP ASSY (WIRELESS)	SCREW M2.5X0.45P+3K-ZK(NL)	86.T19V5.007
	NS	SCREW M2.0X0.4P+2.3FP-ZK	86.T19V5.009
	NS	SCREW M3.0X0.8+3K-NL	86.T19V5.010

Picture	No.	Partname And Description	Part Number
	317-THE SYSTEM	THERMAL SCREW	86.T19V5.011
	321-THE SYSTEM	SCREW M2.0X0.4P+3FP-NI	86.T19V5.013
	NS	SCREW M2X0.4+10FP-NI	86.T19V5.014
	NS	SCREW LOCK 4#X40* 1/5-NI (NL)	86.T19V5.015
	013-Combo ASSY (KME)	SCREW TPB-1.7 3.5P-ZK	86.T19V5.016
	NS	SCREW M2.0*0.4+7FP(T0.8)	86.T19V5.017
	316-THE SYSTEM	THERMAL SCREW (rear)	86.T19V5.018
	NS	SCREW TPB2XM1.7+2.5K-BNI	86.T19V5.019
	NS	SCREW M1.7X0.35+2.5P-ZK	86.T19V5.020
	011-CD-ROM ASSY, DVD ASSY and Combo ASSY	SCREW TPB-2.0X4FP-ZK	86.T19V5.021

Model Definition and Configuration

TravelMate 420 Series

Model Number	CPU	LCD	ODD	Memory	HDD (GB)	FDD (Int. FDD)	WLAN
432XC	Pentium 4 2.53Ghz	14.1 XGA	24x CDRW+DVD	1x256M	40GB	N	N
432LC	Pentium 4 2.53Ghz	15.0 XGA	24x CDRW+DVD	1x256M or 1x512M	30GB	N	N
433XC	Pentium 4 2.66Ghz	14.1 XGA	24x CDRW+DVD	1x256M	40GB	N	N
433LC	Pentium 4 2.66Ghz	15.0 XGA	24x CDRW+DVD	1x256M	40GB	N	N
435LC	Pentium 4 3.06Ghz	15.0 XGA	24x CDRW+DVD	1x256M or 2x256M	40GB	N	N

Main Features

- Intel® Desktop P4P CPU with packing mPGA 478 package
- PC2100 DDR SDRAM, Maximum memory up to 2GB (with two 1024MB SODIMM when available)
- Internal optical drive (swappable with optional drive)
- Removable PCI Bus Master Enhanced IDE hard disk
- Li-Ion main battery pack
- Power management system with ACPI (Advanced Configuration Power Interface)
- Thin-Film Transistor (TFT) liquid-crystal display (LCD) displaying 32-bit high true colour up to 16.7 million colours at 1024X768 eXtended Graphics Array (XGA) resolution for 14.1"/15.0" or 1400x1050 Super eXtended Graphics Array+ (SXGA+) for resolution for some 15.0" models (specification varies depending on models)
- 3D capabilities
- Simultaneous LCD and CRT display support
- S-video for output to a television or display device that supports S-video input
- "Automatic LCD dim" feature that automatically decides the best settings for your display and conserves power
- Dual display capability
- Realtek ALC202 AC'97 Codec audio
- Built-in dual speakers
- Built-in microphone
- High-speed optical drive
- Direct CD Player
- High-speed fax/data modem port
- Ethernet/Fast Ethernet port
- 3 USB 2.0 (Universal Serial Bus) ports
- IEEE 1394 port
- SD/MMC memory slot
- Memory stick slot
- Acer EasyPort port replicator
- Wireless LAN ready (specification varies depending on models)
- Bluetooth ready (specification varies depending on models)
- 4-way scroll button
- Sleek, smooth and stylish design
- Acer FinTouch full-sized curved keyboard
- Ergonomically-centered touchpad pointing device
- One type II CardBus PC Card slots
- Upgradeable memory
- Acer FineTouch keyboard: with 5° curve
- 84/85/88-key windows keyboard, inverted "T" cursor layout, 18mm spacing, 2.5mm (min) key travel
- Built-in touchpad with ergonomic buttons and 4-way integrated scroll key
- 12 function keys; 4 cursor keys; two Windows keys; hotkey controls; 4 launch keys, including Internet browser, email (with LED for received mail), and 2 user-programmable keys

-
- Embedded numeric keypad
 - International language support

Test Compatible Components

This computer's compatibility is tested and verified by Acer's internal testing department. All of its system functions are tested under Windows® XP Home, Windows® XP Pro and Windows® 2000 environment.

Refer to the following lists for components, adapter cards, and peripherals which have passed these tests. Regarding configuration, combination and test procedures, please refer to the TravelMate 430 series Compatibility Test Report released by the Acer Mobile System Testing Department.

Microsoft® Windows® XP Home Environment Test

Item	Specifications
Display	ViewSonic PS775 Philips Brilliance 17" Compal Model Multiscan "G200
Ethernet	D-Link DU-E10USB Ethernet Adapter (10Mbps)
Headset	IBM Viavoice 9.x profesional (US/UK/G/F/I/Spa/Jap/TC/SC)
Speaker	Panasonic EAB-MPC57USB Philips DSS350
Modem	3Com U.S. Roboties 56K Voic Faxmodem Pro (5606)
HDD	IBM 4.5GHDD
Hub	Belkin Express Bus F5U001 D-Link DU-114 USB HUB (4 ports)
ZIP	IOMEGA ZIP100 (LPT)
USB Net Connector	Skywell Magie Toplan
CD-R/RW ROM	Plextor 6X, 12X RICOH MP6200S CD-R/CD-RW
DVD-ROM	Sony 5X DVD ROM DDU220E
HDD box	Datafab 2.5" HDD box
I/O Peripheral	
I/O-Scanner	Logitech Page Scan US13 (USB) Mustek Paragon 1200T (SCSI) Logitech Page Scan Color Pro (LPT)
I/O - printer (parallel)	HP LaserJet 5P HP LaserJet 2100 PCL6(IR) HP DeskJet 500C EPSON Stylus 1000C Canon DeskJet 930C
I/O-printer (USB)	Canon DeskJet 930C Stylus color 740
I/O - TV	Sony 29" television
I/O - Keyboard	Microsoft MS Natural Keyboard IBM keyboard Dell Quietkey Keyboard Acer 6312-H Mitsumi KPQ-E99ZC-12
I/O-Mouse	Microsoft IntelliMouse Microsoft IntelliMouse Track Ball Logitech Mouse Man (M-CV46) Logitech TrackMan Marble FX (T-CJ12) Logitech TrackMan Live (M-RD37) Logitech M-S35 Logitech M-C048 Logitech Cordless MouseMan Wheel (C-RA1)
I/O-Joystick	Toshiba DA2823UJ
I/O-Tablet	Easy Cat Combo Touchpad
I/O-Camera	SONY DIGITAL VIDEO CAMERA RECORDER (FOR 1394) DCR-TRV10

Item	Specifications
I/O - USB	JAZ 2GB Iomega ZIP 100 Sony Electronics USB Floppy Drive Y/E data USB FDD
I/O - USB (Mouse)	Logitech M-UA34 Logitech MouseMan Wheel (M-BA47)
I/O-USB (Keyboard)	Dexim A2U800A Microsoft Natural Keyboard Pro
I/O - USB (Camera)	Intel PC Camera Pro Pack Kodak Digital Camera DC-50
I/O - USB (HUB)	BELKIN Express Bus HUB D-LINK HUB
Com port & PS/2	Logitech M-M35 Logitech Trackman Marble T-CJ12 Logitech Trackman Portable Mouse T-CC3 Logitech MouseMan M-CV46 Logitech Track Man Live (W/L) M-RD37 Microsoft Intellimouse Microsoft Home Mouse
IEEE 1394	
DV	SONY Digital Video TRV20
HDD	Buffalo HDD
MO	Fujitsu DYNA MO640
PCMCIA Card	
Ethernet Card	IBM Ethernet 3Com 3C589B 10baseT Xircom Credit Ethernet 10/100-Ready TDK LAN Flyer (LAK-CB100AX) Accton Fast EtherCard-32
CardBust Card	3Com 32bit 10/100 Base-TX(3C575TX) 3Com 10/100 Lan CardBus (3CCFE575BT) 3Com 10/100 Lan CardBus PC Card with XJACK Connector (3CXFE575BT) Xircom 32-bit CardBus Ethernet 10/10 TDK Network Flyer LAK-CB100AX CardBus 3Com Megahertz 10/100 LAN CardBus (3CCFE575CT) Xircom 32 bit Xircom CardBus Modem 56 WinGlobal (CBM56WG) 3Com Fast Ethernet 10/100 BASE-TX (3CCFE575CT-D) Xircom Ethernet 10/100+Modem 56K (RBEM56G-100) 3Com CardBus with XJACK Connector (3CXFE575BT)
Multi-Function Card	3Com 3C562D/3C563D 3Com 10/100LAN+56K Modem (3CCFEM656B) Xircom CreditCard Ethernet+33.6 Modem Xircom CardBus Ethernet 10/100+Modem56 (RBEM56G-100)
Modem Card	Xircom RealPort Modem56 (RM56V1) Action Tec Data Link 56K PC Card Fax Modem (MDV9012-01) 3Com 56K WinModem PC Card with XJACK Connector (3CXM356) BLASTER Modem 56K Flash56 PCMCIA (D15610) 3Com 56K Winmodem (Model: 3013)
ISDN Card	Megahertz USRobotics 128K ISDN

Item	Specifications
Flash Card	Kingston 64MB Feiya CompactFlash Card (32MB) Feiya Smart Media Flash Memory Card To PCMCIA (32MB)
ATA Card	Sundisk 2.5MB HP 10MB Kingston 64MB Toshiba 2G MK20001MPL Toshiba 5G MK5002MPL IOMEGA Click ! PC Card 40MB C-40T2
SCSI Card	Adaptec SlimSCSI 16bit Adaptec SlimSCSI 1480A (Card Bus)
IEEE 1394 PC Card	DELL IEEE-1394a PC Card
Wireless LAN Card	3Com 3CRW737A Cisco AIR-PCM340
Smart Media Card	Toshiba 2MB_5V, 2MB_3.3V Toshiba 4MB_5VX2, 4MB_3.3VX2 Toshiba 16MB 3.3V Toshiba 32MB 3.3V Toshiba 64MB 3.3V Toshiba 128MB 3.3V
SD Card	Panasonic 8MB RP-SD008 Panasonic 16MB RP-SD016 Panasonic 32MB RP-SD032 Panasonic 64MB RP-SD064 Toshiba 8MB SD-M08 Toshiba 16MB SD-M016 Toshiba 32MB SD-M032 Toshiba 64MB SD-M064
Bluetooth Card	Toshiba PC Card Toshiba Modem Card

Microsoft® Windows® XP Pro Environment Test

Item	Specifications
Display	LCD 14.1" TFT (XGA)-- AU UB141X03 CPT CLAA141XF01 LCD15.0" TFT (1024x768 XGA)-- AU B150XN01 LG LP150X04 HITACHI TX38D85VC1CAB LCD 15.0" TFT (1024x768 SXGA+)-- CPT CLAA105PA01 LG LP150E01-A2M2 IBM ITSX95C
Video	Viewsonic 17PS Sony MultiScan G200 DELL Ultra Scan P991 Ext TV
Ethernet	D-Link Ethernet Adapter
Audio	
Headphone	General headphone
Microphone	General MIC
Speaker	Panasonic EAB-MPC57USB
FDD	1.44MB floppy disk drive
I/O Peripheral	
I/O - printer (parallel)	HP LaserJet 5P HP LaserJet 2100 PCL6(IR) EPSON color 740
I/O - TV	Sony KV-W32MX2
I/O - Keyboard	Darfon Natural USB keyboard Pro Chicony KU-8933 USB keyboard
I/O - USB	JAZ 2GB Iomega ZIP 100 USB HDD MITSUMI USB FDD
I/O - USB (Mouse)	Logitech M-BD58 Logitech M-UA34 Logitech M-UB48 Microsoft IntelliMouse Explorer
I/O - USB (Speaker)	Panasonic EAB-MPC57USB
I/O - USB (Camera)	Intel PC Camera Pro Pack
I/O - USB (ZIP)	Iomega ZIP 100
I/O - USB (HUB)	BELKIN Express Bus HUB D-LINK HUB

Item	Specifications
Com port & PS/2	Logitech M-M35 Logitech Trackman Marble T-CJ12 Logitech Trackman Portable Mouse T-CC3 Logitech MouseMan M-CV46 Logitech Track Man Live (W/L) M-RD37 Microsoft Intellimouse Microsoft Home Mouse
I/O Adapter	
PCMCIA	Xircom 32-bit Card bus 10/100 Com 32-bit Card bus 10/100 BASE-TX (3C575-TX) Xircom Ethernet 10/100+Modem 56K(CBEM56G-100) Xircom RealPort Card Ethernet 10/100+ Modem56(RBEM56G-100) Toshiba Type II PCMCIA 2G HDD 3COM Airconnect(3CRWE737A) wireless LAN card Cisco Aironet 340(AIR-PCM340)wireless LAN card lomeage Klik! PC Card 40MB LEXAR Compact Flash Card (16MB) RITEK Compact Flash Memory (128MB) HITACHI CompactFlash Memory (64MB) DELL IEEE 1394a PC Card

Microsoft® Windows® 2000 Environment Test

Item	Specifications
Display	LCD 14.1" TFT (XGA)-- AU UB141X03 CPT CLAA141XF01 LCD15.0" TFT (1024x768 XGA)-- AU B150XN01 LG LP150X04 HITACHI TX38D85VC1CAB LCD 15.0" TFT (1024x768 SXGA+)-- CPT CLAA105PA01 LG LP150E01-A2M2 IBM ITSX95C
Video	Viewsonic 17PS Sony MultiScan G200 DELL Ultra Scan P991 Ext TV
Ethernet	D-Link Ethernet Adapter
Audio	
Headphone	General headphone
Microphone	General MIC
Speaker	Panasonic EAB-MPC57USB
FDD	1.44MB floppy disk drive
I/O Peripheral	
I/O - printer (parallel)	HP LaserJet 5P HP LaserJet 2100 PCL6(IR) EPSON color 740
I/O - TV	Sony KV-W32MX2
I/O - Keyboard	Darfon Natural USB keyboard Pro Chicony KU-8933 USB keyboard
I/O - USB	JAZ 2GB Iomega ZIP 100 USB HDD MITSUMI USB FDD
I/O - USB (Mouse)	Logitech M-BD58 Logitech M-UA34 Logitech M-UB48 Microsoft IntelliMouse Explorer
I/O - USB (Speaker)	Panasonic EAB-MPC57USB
I/O - USB (Camera)	Intel PC Camera Pro Pack
I/O - USB (ZIP)	Iomega ZIP 100
I/O - USB (HUB)	BELKIN Express Bus HUB D-LINK HUB

Item	Specifications
Com port & PS/2	Logitech M-M35 Logitech Trackman Marble T-CJ12 Logitech Trackman Portable Mouse T-CC3 Logitech MouseMan M-CV46 Logitech Track Man Live (W/L) M-RD37 Microsoft Intellimouse Microsoft Home Mouse
I/O Adapter	
PCMCIA	Xircom 32-bit Card bus 10/100 Com 32-bit Card bus 10/100 BASE-TX (3C575-TX) Xircom Ethernet 10/100+Modem 56K(CBEM56G-100) Xircom RealPort Card Ethernet 10/100+ Modem56(RBEM56G-100) Toshiba Type II PCMCIA 2G HDD 3COM Airconnect(3CRWE737A) wireless LAN card Cisco Aironet 340(AIR-PCM340)wireless LAN card lomeage Klik! PC Card 40MB LEXAR Compact Flash Card (16MB) RITEK Compact Flash Memory (128MB) HITACHI CompactFlash Memory (64MB) DELL IEEE 1394a PC Card

Online Support Information

This section describes online technical support services available to help you repair your Acer Systems.

If you are a distributor, dealer, ASP or TPM, please refer your technical queries to your local Acer branch office. Acer Branch Offices may access our website. However some information sources will require a user i.d. and password. These can be obtained directly from Acer CSD Taiwan.

Acer's Website offers you convenient and valuable support resources whenever you need them.

In the Technical Information section you can download information on all of Acer's Notebook, Desktop and Server models including:

- Service guides for all models
- User's manuals
- Training materials
- Bios updates
- Software utilities
- Spare parts lists
- TABs (Technical Announcement Bulletin)

For these purposes, we have included an Acrobat File to facilitate the problem-free downloading of our technical material.

Also contained on this website are:

- Detailed information on Acer's International Traveler's Warranty (ITW)
- Returned material authorization procedures
- An overview of all the support services we offer, accompanied by a list of telephone, fax and email contacts for all your technical queries.

We are always looking for ways to optimize and improve our services, so if you have any suggestions or comments, please do not hesitate to communicate these to us.

A

- AC Adapter 31
- ACPI 1.0a 23
- AFLASH Utility 50
- Audio 25, 26

B

- Battery 27
- Battery Pack 63
- battery pack
 - charging indicator 12
- BIOS 23
 - package 23
 - password control 23
 - ROM size 23
 - ROM type 23
 - vendor 23
 - Version 23
- BIOS Setup Utility 37
- BIOS Supports protocol 23
- BIOS Utility 37
 - Basic System Settings 43
 - Navigating 37
 - Onboard Device Configuration 45
 - Startup Configuration 44
 - System Information 39
 - System Security 39, 49
- Board Layout 4
 - Bottom View 5
 - Top View 4

C

- Cache
 - controller 23
 - size 23
- caps lock
 - on indicator 12
- CardBus 26
- computer
 - on indicator 12
- CPU
 - core voltage 23
 - package 23
 - type 23

D

- DIMM 23
 - Combinations 24
 - external 64
 - package 23
 - removing 64
 - Speed 23
 - voltage 23
- Disassembly
 - Battery Pack 62
 - CD-ROM/DVD-ROM Module 67
 - Floppy Disk Drive 72
 - Machine 59
 - Procedure Flowchart 61
- Display 3
- DVD-ROM Interface 25

E

- Error Symptom-to-Spare Part Index 81
- External CD-ROM Drive Check 76

F

- Features 1
- features 119
- Flash Utility 50
- Floppy Disk
 - removing the 72
- FRU (Field Replaceable Unit) List 99

H

- Hard disk 24, 26
- HDD 24, 26
- Hot Keys 13

I

- Indicators 12
- Intermittent Problems 87

J

- Jumper and Connector Locations 95
 - Top View 95

K

- Keyboard 27

Keyboard or Auxiliary Input Device Check 77

L

L2 cache 23

LAN/Modem Combo 24

M

Machine Disassembly 59

media access

 on indicator 12

Memory Check 77

Model Definition 118

Modem 24

Modem Combo Card

 external 65

N

num lock

 on indicator 12

O

Online Support Information 129

P

Panel 6

 Bottom 11

 left 6

 Rear 9

 right 9

Parallel Port 26

PC Card 12, 26

PCMCIA 26

Pentium III 23

Power System Check

 Battery Pack 79

 Power Adapter 78, 79

Processor 23

R

RMA 99

RTC 27

S

Second Level Cache 23

Super I/O 26

System

 Block Diagram 3

 Layout 4

System Check Procedures 76

System Diagnostic Diskette 50

System Memory 23

System Specifications

 Features 119

System Utilities 37

System Utility Diskette 50

T

Temperature 32

Test Compatible Components 121

Touchpad Check 79

Troubleshooting 75

U

Undetermined Problems 88

USB 26

utility

 BIOS 37

V

Video 25

 Resolutions 25

Video controller 26

W

Windows 2000 Environment Test 122