

# Acer TravelMate 800 Series

## Service Guide

Service guide files and updates are available on the ACER/CSD web; for more information, please refer to <http://csd.acer.com.tw>

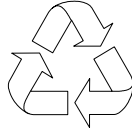

100% Recycled Paper

PART NO.: VD.T25V7.001

PRINTED IN TAIWAN

---

## Revision History

Please refer to the table below for the updates made on TravelMate 800 service guide.

Date	Chapter	Updates

---

## Copyright

Copyright © 2003 by Acer Incorporated. All rights reserved. No part of this publication may be reproduced, transmitted, transcribed, stored in a retrieval system, or translated into any language or computer language, in any form or by any means, electronic, mechanical, magnetic, optical, chemical, manual or otherwise, without the prior written permission of Acer Incorporated.

## Disclaimer

The information in this guide is subject to change without notice.

Acer Incorporated makes no representations or warranties, either expressed or implied, with respect to the contents hereof and specifically disclaims any warranties of merchantability or fitness for any particular purpose. Any Acer Incorporated software described in this manual is sold or licensed "as is". Should the programs prove defective following their purchase, the buyer (and not Acer Incorporated, its distributor, or its dealer) assumes the entire cost of all necessary servicing, repair, and any incidental or consequential damages resulting from any defect in the software.

Acer is a registered trademark of Acer Corporation.  
Intel is a registered trademark of Intel Corporation.  
Pentium and Pentium II/III are trademarks of Intel Corporation.  
Other brand and product names are trademarks and/or registered trademarks of their respective holders.

---

## Conventions

The following conventions are used in this manual:

<b>SCREEN MESSAGES</b>	Denotes actual messages that appear on screen.
<b>NOTE</b>	Gives bits and pieces of additional information related to the current topic.
<b>WARNING</b>	Alerts you to any damage that might result from doing or not doing specific actions.
<b>CAUTION</b>	Gives precautionary measures to avoid possible hardware or software problems.
<b>IMPORTANT</b>	Reminds you to do specific actions relevant to the accomplishment of procedures.

---

## Preface

Before using this information and the product it supports, please read the following general information.

1. This Service Guide provides you with all technical information relating to the BASIC CONFIGURATION decided for Acer's "global" product offering. To better fit local market requirements and enhance product competitiveness, your regional office MAY have decided to extend the functionality of a machine (e.g. add-on card, modem, or extra memory capability). These LOCALIZED FEATURES will NOT be covered in this generic service guide. In such cases, please contact your regional offices or the responsible personnel/channel to provide you with further technical details.
2. Please note WHEN ORDERING FRU PARTS, that you should check the most up-to-date information available on your regional web or channel. If, for whatever reason, a part number change is made, it will not be noted in the printed Service Guide. For ACER-AUTHORIZED SERVICE PROVIDERS, your Acer office may have a DIFFERENT part number code to those given in the FRU list of this printed Service Guide. You MUST use the list provided by your regional Acer office to order FRU parts for repair and service of customer machines.



# Table of Contents

<b>Chapter 1</b>	<b>System Specifications</b>	<b>1</b>
	Features . . . . .	1
	Block Diagram . . . . .	3
	Board Layout . . . . .	4
	Top View . . . . .	4
	Bottom View . . . . .	5
	Outlook View . . . . .	6
	Front Open View . . . . .	6
	Front Panel . . . . .	7
	Left Panel . . . . .	8
	Right Panel . . . . .	9
	Rear Panel . . . . .	10
	Bottom Panel . . . . .	11
	Indicators . . . . .	12
	Lock Keys . . . . .	13
	Embedded Numeric Keypad . . . . .	14
	Windows Keys . . . . .	15
	Hot Keys . . . . .	16
	The Euro Symbol . . . . .	18
	Launch Keys . . . . .	19
	E-Mail Detection . . . . .	20
	Touchpad . . . . .	21
	Touchpad Basics . . . . .	21
	Hardware Specifications and Configurations . . . . .	22
<b>Chapter 2</b>	<b>System Utilities</b>	<b>33</b>
	BIOS Setup Utility . . . . .	33
	Navigating the BIOS Utility . . . . .	34
	Info . . . . .	35
	Main . . . . .	36
	System Devices . . . . .	38
	Security . . . . .	39
	Boot . . . . .	42
	Exit . . . . .	43
	BIOS Flash Utility . . . . .	44
	System Diagnostic Diskette . . . . .	45
<b>Chapter 3</b>	<b>Machine Disassembly and Replacement</b>	<b>47</b>
	General Information . . . . .	48
	Before You Begin . . . . .	48
	Disassembly Procedure Flowchart . . . . .	49
	Removing the ODD Module / HDD Module / Memory / Wireless LAN card . . . . .	52
	Removing the ODD Module . . . . .	52
	Removing the HDD Module . . . . .	52
	Removing the Wireless LAN Card . . . . .	52
	Removing the Memory . . . . .	53
	Removing the LCD Module / Keyboard / Function Keyboard . . . . .	53
	Removing the Function Keyboard . . . . .	55
	Disassembling the Main Unit . . . . .	55
	Removing the Touchpad . . . . .	57
	Removing the Memory . . . . .	57
	Removing the Thermal Module . . . . .	58

# Table of Contents

Removing the CPU . . . . .	58
Removing the Main Board . . . . .	58
Removing the Modem / Bluetooth Card . . . . .	58
Disassembling the LCD Module . . . . .	59
Disassembling External Modules . . . . .	61
Disassembling the ODD Module . . . . .	61
Disassembling the HDD Module . . . . .	61
<b>Chapter 4     Troubleshooting</b>	<b>63</b>
System Check Procedures . . . . .	64
External Diskette Drive Check . . . . .	64
External CD-ROM/DVD-ROM Drive Check . . . . .	64
Keyboard or Auxiliary Input Device Check . . . . .	65
Memory Check . . . . .	65
Power System Check . . . . .	65
Touchpad Check . . . . .	67
Display Check . . . . .	67
Sound Check . . . . .	68
Power-On Self-Test (POST) Error Message . . . . .	69
Index of Error Messages . . . . .	70
Index of Symptom-to-FRU Error Message . . . . .	72
Intermittent Problems . . . . .	75
Undetermined Problems . . . . .	76
Index of AFlash BIOS Error Message . . . . .	77
<b>Chapter 5     FRU (Field Replaceable Unit) List</b>	<b>79</b>
<b>Appendix A    Model Definition and Configuration</b>	<b>96</b>
TravelMate 800 Series . . . . .	96
Main Features . . . . .	97
<b>Appendix B    Test Compatible Components</b>	<b>99</b>
Microsoft® Windows® XP Environment Test . . . . .	100
Microsoft® Windows® 2000 Environment Test . . . . .	104
<b>Appendix C    Online Support Information</b>	<b>109</b>
<b>Index</b>	<b>111</b>



# System Specifications

---

## Features

This computer was designed with the user in mind. Here are just a few of its many features:

### Performance

- Intel® Pentium® M Processor, 1.3 GHz ~ 1.6GHz
- Intel 885PM (ODEM) + ICH4 chipset
- 2 memory slots supporting DDR266 SDRAM (PC-2100), upgradeable to 2GB
- 30 GB or higher capacity Enhanced-IDE hard disk
- Microsoft Windows XP operating system / Windows 2000 operating system

### Display

- The 14.1" XGA TFT LCD with 1024 x 768 pixel resolution, 16.7 million colors
- The 15.0" SXGA+ TFT LCD with 1400 x 1050 pixel resolution, 16.7 million colors
- The 15.0" UXGA TFT LCD with 1600 x 1200 pixel resolution, 16.7 million colors
- TravelMate 800 series notebook computer features an accelerated graphics port (AGP) video system in the ATI Mobility Radeon 9000 chipset. This provides a robust solution and enables high quality video output.
- Simultaneous LCD, external monitor or projector display

### Multimedia

- Build-in optical drive (CD-ROM, DVD-ROM, or DVD/CD-RW combo drive)
- 14.1" or 15.0" XGA, SXGA+ or UXGA TFT LCD Panel
- Build-in stereo speakers
- Audio input and output jacks
- Built-in internal microphone

### Connectivity

- Built-in 10/100 Mbps Ethernet connection
- Built-in 56Kbps fax/data modem
- 4 Universal Series Bus (USB) ports

### Human-centric design and ergonomics

- All-in-one design (incorporating hard drive and optical drive)
- Rugged, yet extremely portable, construction
- Stylish appearance
- Full-size keyboard with 4 programmable launch keys
- Comfortable palm rest area with well-positioned touchpad

### Expansion

- Upgradeable memory modules and hard disk
- PC card slot enables a range of add-on options

---

### **Keyboard and Pointing Device**

- 84-/85-/88-key Windows keyboard
- Ergonomically-centered touchpad pointing device

### **I/O Ports**

- One PCMCIA slot (type II or type III)
- One RJ-11 modem jack (V.90, 56K)
- One RJ-45 network jack (Ethernet 10/100 mbps)
- One DC-in jack
- One parallel port (ECP/EPP compliant)
- One VGA (external monitor) port
- One headphone-out jack (3.5mm minijack)
- One microphone-in jack (3.5mm minijack)
- One line-in jack (3.5mm minijack)
- Four Universal Serial Bus (USB) ports
- One easy replicator port
- One TV-out port
- One IEEE-1394 port
- One Smart Card slot

# Block Diagram

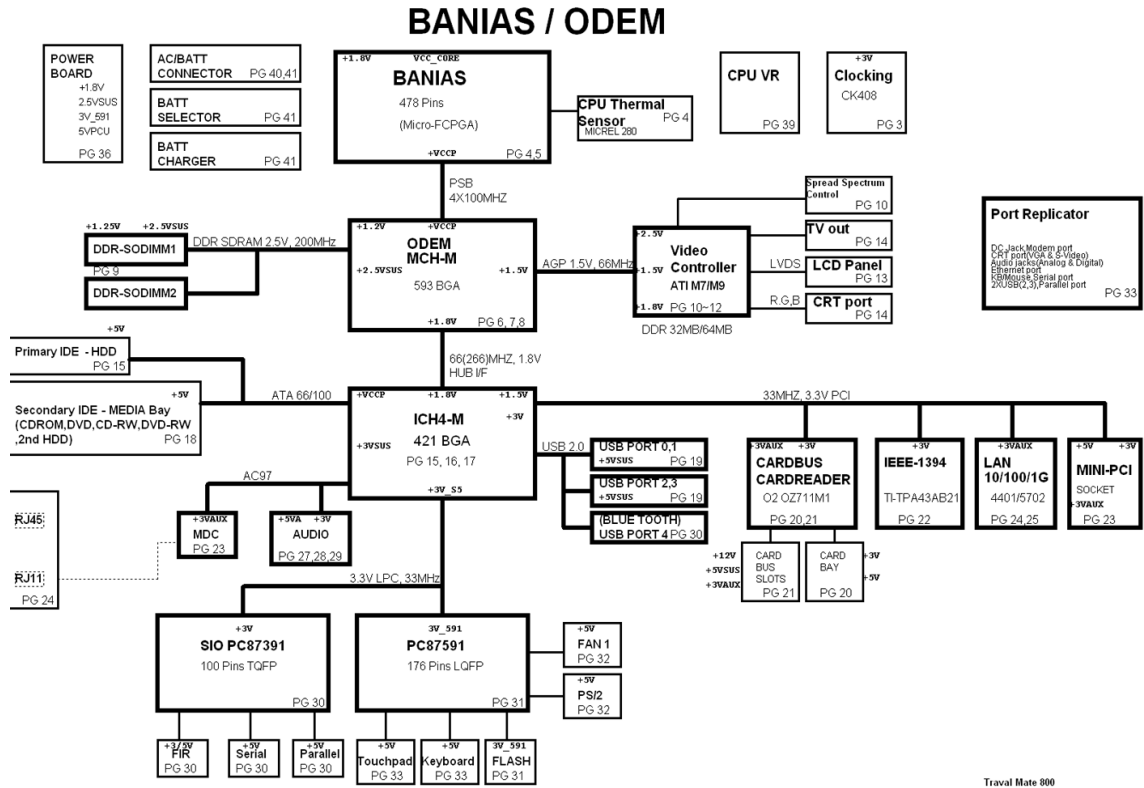

Travel Mate 800

# Board Layout

## Top View

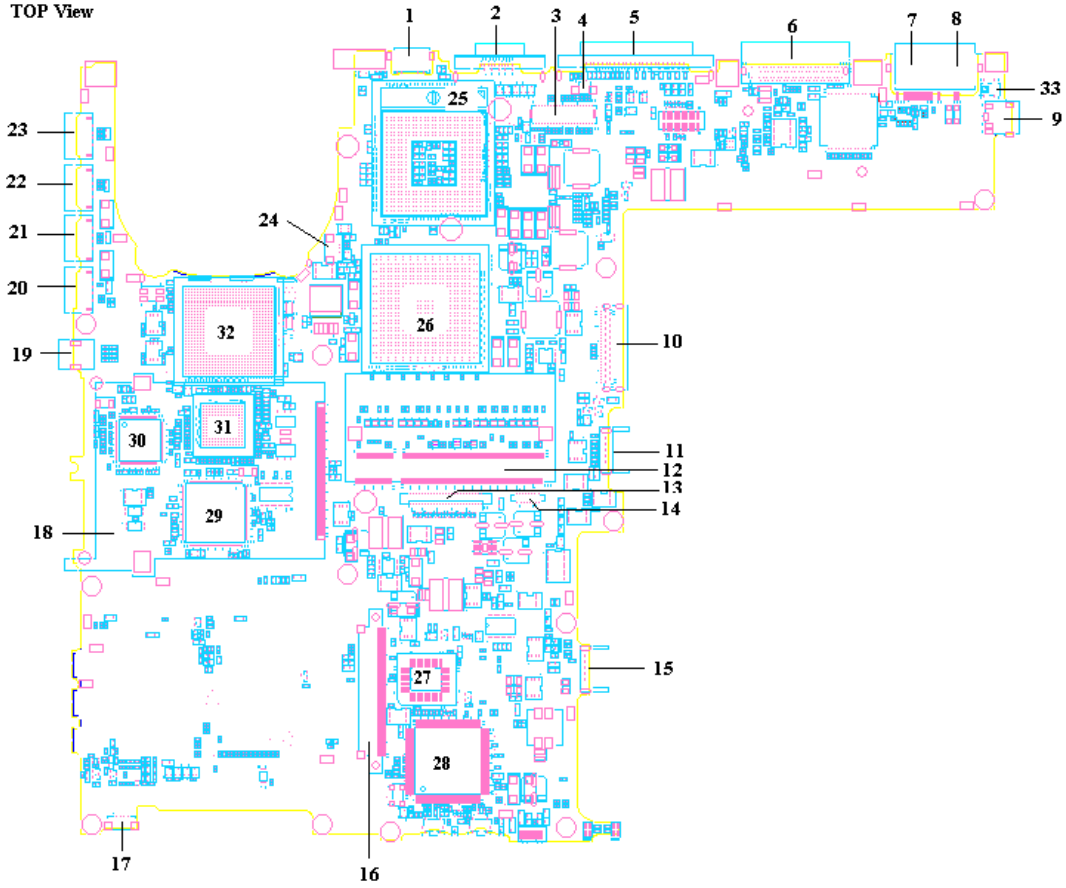

- |    |                               |    |                          |
|----|-------------------------------|----|--------------------------|
| 1  | TV-out connector              | 18 | Cardbus connector        |
| 2  | VGA port                      | 19 | IEEE-1394 connector      |
| 3  | LCD cable connector           | 20 | USB port                 |
| 4  | Internal microphone connector | 21 | USB port                 |
| 5  | Parallel port                 | 22 | USB port                 |
| 6  | Easy replicator port          | 23 | USB port                 |
| 7  | LAN connector                 | 24 | Fan connector            |
| 8  | Modem connector               | 25 | CPU socket               |
| 9  | Adapter connector             | 26 | ODEM (North Bridge)      |
| 10 | CD/DVD-ROM module connector   | 27 | BIOS                     |
| 11 | Battery connector             | 28 | EC/KBC 87591             |
| 12 | DIMM socket 1                 | 29 | OZ711MI                  |
| 13 | Keyboard FFC connector        | 30 | TSB43AB21                |
| 14 | Touchpad FFC connector        | 31 | BCM4401                  |
| 15 | Battery connector             | 32 | ATI Mobility Radeon 9000 |
| 16 | HDD module connector          | 33 | Lid close switch         |
| 17 | Speaker connector             |    |                          |

## Bottom View

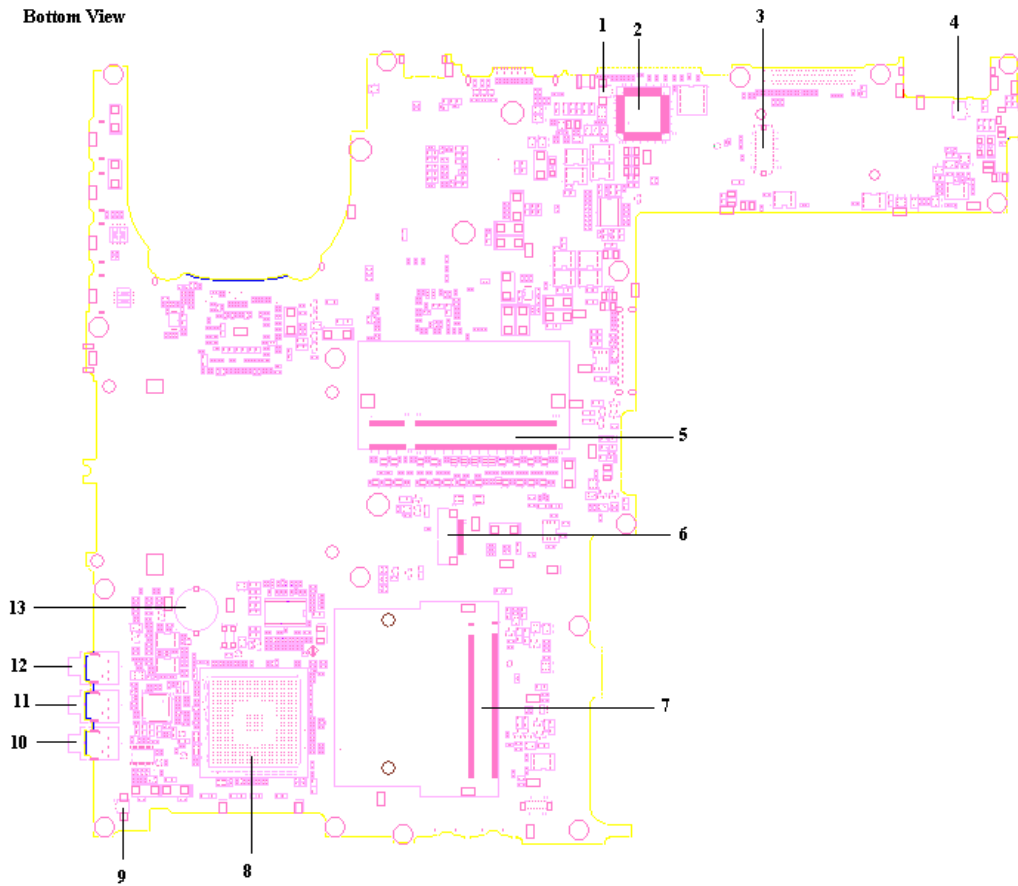

- |   |                                     |    |                                     |
|---|-------------------------------------|----|-------------------------------------|
| 1 | Internal microphone cable connector | 8  | South Bridge (ICH4-M)               |
| 2 | Super I/O PC87391                   | 9  | Internal microphone cable connector |
| 3 | MDC connector                       | 10 | Headphone jack                      |
| 4 | Modem cable connector               | 11 | External microphone jack            |
| 5 | DIMM socket 2                       | 12 | Line-in jack                        |
| 6 | Smart Card connector                | 13 | RTC Battery socket                  |
| 7 | Mini-PCI socket                     |    |                                     |

## Outlook View

A general introduction of ports allow you to connect peripheral devices, as you would with a desktop PC.



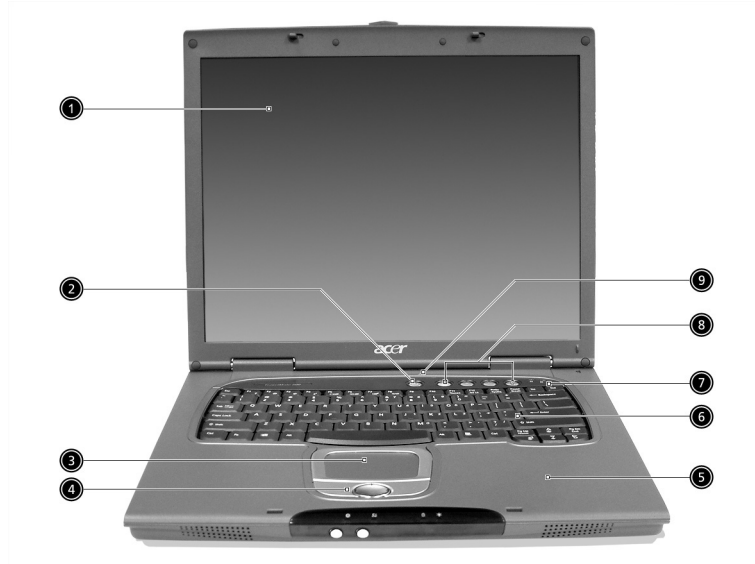

### Front Open View

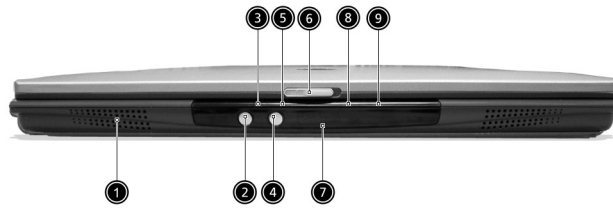

#	Icon	Item	Description
1		Display screen	Also called LCD (liquid-crystal display), displays computer output.
2		Power button	Turns on the computer.
3		Touchpad	Touch-sensitive pointing device which functions like a computer mouse.
4		Click buttons (left, center and right)	The left and right buttons function like the left and right mouse buttons; the center button serves as a 4-way scroll button.
5		Palmrest	Comfortable support area for your hands when you use the computer.
6		Keyboard	Inputs data into your computer.
7		Status indicators	LEDs (light-emitting diode) that turn on and off to show the status of the computer, its functions and components.
8		Launch keys	4 buttons that be programmed to launch Internet browser, E-mail program and to start frequently used applications.
9		Microphone	Internal microphone for sound recording.







## Front Panel

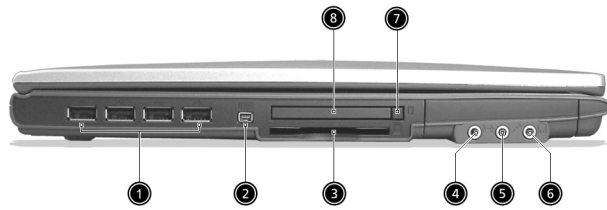

#	Icon	Item	Description
1		Speaker	Outputs sound.
2		Bluetooth button	Starts (optional) Bluetooth functionality.
3		Bluetooth indicator	Indicates that (optional) Bluetooth is enabled.
4		InviLink button	Opens (optional) wireless connectivity.
5		InviLink indicator	Indicates status of (optional) wireless communication.
6		Latch	Latch for opening and closing the laptop.
7		Infrared port	Interfaces with infrared devices (e.g., infrared printer, IR-aware computer).
8		Battery indicator	Lights orange when the battery is charging. Lights green when the battery is full.
9		Power status indicator	Lights green when the power is on and orange when the computer is in standby mode.

## Left Panel



#	Icon	Item	Description
1		Four (4) USB 2.0 ports	Connect to Universal Serial Bus devices (e.g., USB mouse, USB camera).
2		IEEE 1394 port	Connects to IEEE 1394 devices.
3		Smart Card slot	Slot for Smart Card interface with pre-boot authentication system.
4		Line-in jack	Accepts audio line-in devices (e.g., audio CD player, stereo walkman).
5		Microphone Jack	Accepts input from external microphones.
6		Headphone/ Speaker/ Line-out jack	Connect to headphones or other line-out audio devices (speakers).
7		PC Card eject button	Ejects the PC Card from the slot.
8		PC Card slot	Accepts one Type II 16-bit PC Card or 32-bit CardBus PC Card.





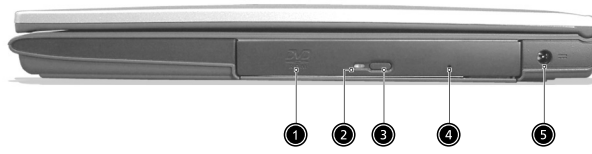



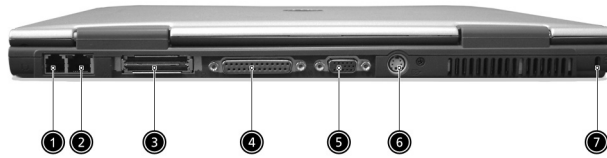

## Right Panel



#	Icon	Item	Description
1		AcerMedia drive	Houses a removable media drive module.
2		AcerMedia indicator	Lights up when the AcerMedia drive is active.
3		Eject button	Ejects the drive tray.
4		Emergency eject slot	Ejects the drive tray when the computer is turned off.
5		Power jack	Connects to an AC adapter.

## Rear Panel



#	Icon	Item	Description
1		Modem jack	Connects to a phone line.
2		Network jack	Connect to an Ethernet 10/100-based network.
3		Expansion port	Connects to I/O port replicator or EasyPort expansion devices.
4		Parallel port	Connects to a parallel device (e.g., parallel printer).
5		External display port	Connects to a display device (e.g., external monitor, LCD projector).
6		S-video	Connects to a television or display device with S-video input.
7		Security keylock	Connects to a Kensington-compatible computer security lock.

## Bottom Panel

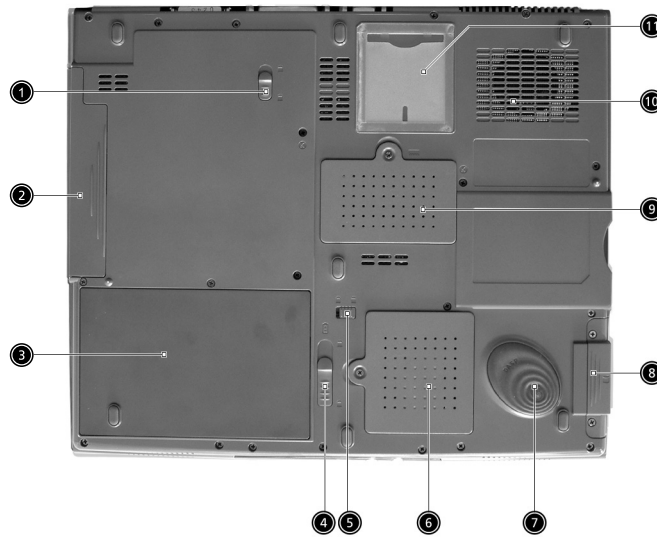

#	Icon	Item	Description
1		AcerMedia bay release latch	Unlatches the AcerMedia drive for removing the optical drive.
2		AcerMedia bay	Houses an AcerMedia drive module.
3		Battery bay	Houses the computer's battery pack.
4		Battery release latch	Unlatches the battery to remove the battery pack.
5		Battery lock	Locks the battery in place.
6		Mini-PCI slot	Slot for adding mini-PCI cards.
7		Hard disk protector	Protects the hard disk from accidental bumps and vibration.
8		Hard disk bay	Houses the computer's hard disk (secured by a screw).
9		Memory compartment	Houses the computer's memory.
10		Cooling fan	Helps keep the computer cool. Note: Don't cover or obstruct the opening of the fan.
11		Personal identification slot	Insert a business card or similar-sized identification card to personalize your computer.

## Indicators

The computer has three easy-to-read status indicators below the display screen, and two on the front of the computer.



The Battery and Power status indicators are visible even when you close the display.

Icon	Function	Description
	Caps lock	Lights when Caps Lock is activated.
	Num lock	Lights when Num Lock is activated.
	Media Activity	Lights when the disc or AcerMedia is activated.
	Battery	Lights orange when the battery is charging. Lights green when the battery is full.
	Power	Lights green when the power is on and orange when the computer is in standby mode.

## Lock Keys

The keyboard has three lock keys which you can toggle on and off.

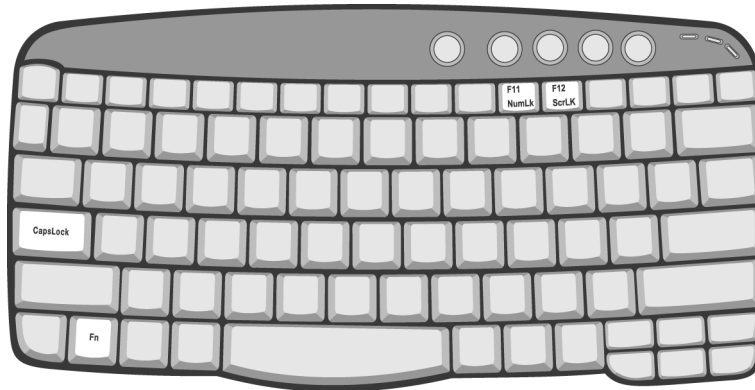

Lock Key	Description
Caps Lock	When Caps Lock is on, all alphabetic characters typed are in uppercase.
Num lock (Fn-F11)	When Num Lock is on, the embedded keypad is in numeric mode. The keys function as a calculator (complete with the arithmetic operators +, -, *, and /). Use this mode when you need to do a lot of numeric data entry. A better solution would be to connect an external keypad.
Scroll lock (Fn-F12)	When Scroll Lock is on, the screen moves one line up or down when you press the up or down arrow keys respectively. Scroll Lock does not work with some applications.

## Embedded Numeric Keypad

The embedded numeric keypad functions like a desktop numeric keypad. It is indicated by small characters located on the upper right corner of the keycaps. To simplify the keyboard legend, cursor-control key symbols are not printed on the keys.

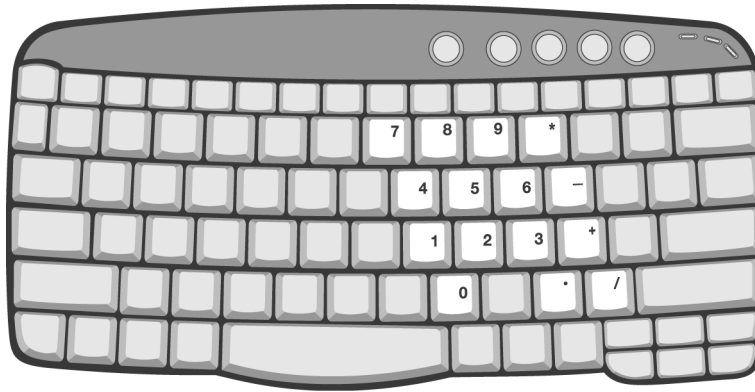







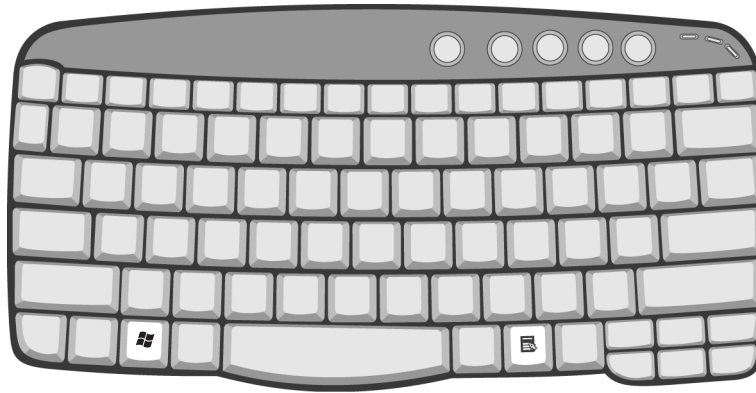

Desired Access	Num Lock On	Num Lock Off
Number keys on embedded keypad	Type numbers in a normal manner.	
Cursor-control keys on embedded keypad	Hold Shift while using cursor-control keys.	Hold Fn while using cursor-control keys.
Main keyboard keys	Hold Fn while typing letters on embedded keypad.	Type the letters in a normal manner.

## Windows Keys

The keyboard has two keys that perform Windows-specific functions.



Key	Icon	Description
Windows logo key		Start button. Combinations with this key perform shortcut functions. Below are a few examples: <ul style="list-style-type: none"> <li> + Tab (Activates next taskbar button)</li> <li> + E (Explores My Computer)</li> <li> + F (Finds Document)</li> <li> + M (Minimizes All)</li> </ul> Shift +  + M (Undoes Minimize All)  + R (Displays the Run... dialog box)
Application key		Opens a context menu (same as a right-click).

## Hot Keys

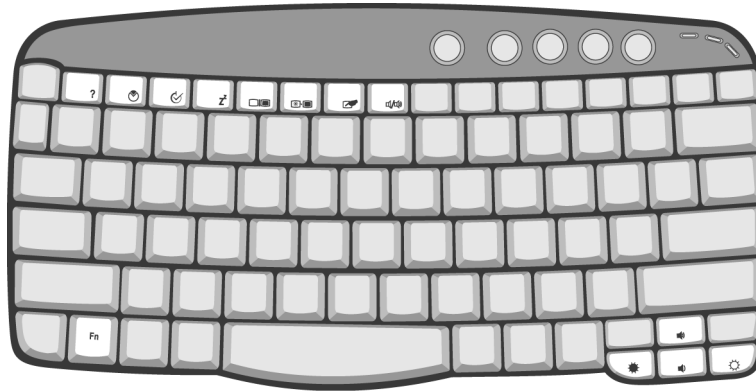

The computer employs hot keys or key combinations to access most of the computer's controls like screen brightness, volume output and the BIOS Utility.

To activate hot keys, press and hold the **Fn** key before pressing the other key in the hot key combination.



Hot Key	Icon	Function	Description
Fn-F1	?	Hot key help	Displays help on hot keys.
Fn-F2		Setup	Accesses the computer's configuration utility.
Fn-F3		Power management scheme toggle	Switches the power management scheme used by the computer (function available if supported by operating system). See "Power management" on page 25.
Fn-F4	Zz	Sleep	Puts the computer in Sleep mode. See "Power management" on page 25.
Fn-F5		Display toggle	Switches display output between the display screen, external monitor (if connected) and both the display screen and external monitor.
Fn-F6		Screen blank	Turns the display screen backlight off to save power. Press any key to return.
Fn-F7		Touchpad toggle	Turns the internal touchpad on and off.
Fn-F8		Speaker toggle	Turns the speakers on and off.
Fn-↑		Volume up	Increases the speaker volume.
Fn-↓		Volume down	Decreases the speaker volume.



Hot Key	Icon	Function	Description
Fn→		Brightness up	Increases the screen brightness.
Fn←		Brightness down	Decreases the screen brightness

## The Euro Symbol

If your keyboard layout is set to United States-International or United Kingdom or if you have a keyboard with a European layout, you can type the Euro symbol on your keyboard.



**NOTE:** For US keyboard users: The keyboard layout is set when you first set up Windows. For the Euro symbol to work, the keyboard layout has to be set to United States-International.

To verify the keyboard type in Windows Millennium Edition and Windows 2000, follow the steps below:

1. Click on **Start, Settings, Control Panel**.
2. Double-click on **Keyboard**.
3. Click on the **Language** tab.
4. Verify that keyboard layout used for "En English (United States)" is set to United States-International. If not, select and click on **Properties**; then select **United States-International** and click on **OK**.

If not, select and click on Properties; then select United States-International and click on OK.

5. Click on **OK**.

To verify the keyboard type in Windows XP, follow the steps below:

1. Click on **Start, Control Panel**.
2. Double-click on **Regional and Language Options**.
3. Click on the **Language** tab and click on **Details**.
4. Verify that the keyboard layout used for "En English (United States)" is set to United States-International.

If not, select and click on **ADD**; then select **United States-International** and click on **OK**.

5. Click on **OK**.

To type the Euro symbol:

1. Locate the Euro symbol on your keyboard.
2. Open a text editor or word processor.
3. Hold **Alt Gr** and press the Euro symbol.

**NOTE:** Some fonts and software do not support the Euro symbol. Please refer to [www.microsoft.com/typography/faq/faq12.htm](http://www.microsoft.com/typography/faq/faq12.htm) for more information.

## Launch Keys

Located above the keyboard are five buttons. The left-most button is the power button. To the right of the power button are the four launch keys. They are designated as the mail button, the web browser button, and two programmable buttons (P1 and P2).



Launch Key	Default application
Email	Email application
Web browser	Internet browser application
P1	User-programmable
P2	User-programmable

## E-Mail Detection

Click right button at the Launch Manager icon on the taskbar and click on E-Mail Detection. In this dialog box, you have the option to enable/disable mail checking, set the time interval for mail checking, etc. If you already have an email account, you can fill in User Name, Password and POP3 Server in the dialog box. The POP3 Server is the mail server where you get your email.

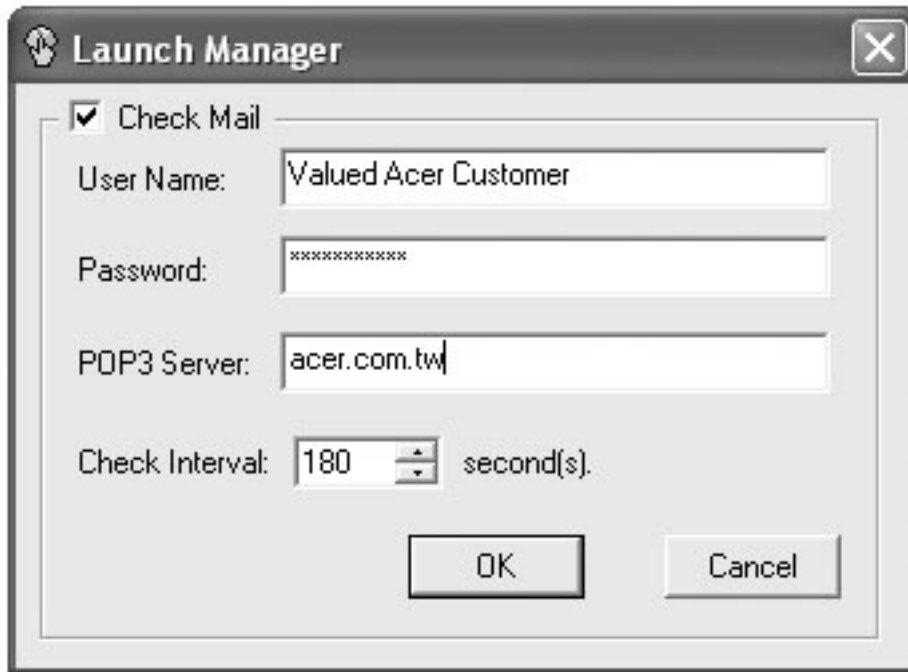

Aside from the email checking function, there is a mail button that is used to launch the email application. It is located above the keyboard right below the LCD.

## Touchpad

The built-in touchpad is a pointing device that senses movement on its surface. This means the cursor responds as you move your finger on the surface of the touchpad. The central location on the palmrest provides optimal comfort and support.

**NOTE:** If you are using an external USB mouse, you can press **Fn-F7** to disable the touchpad.



### Touchpad Basics

The following teaches you how to use the touchpad:



- Move your finger across the touchpad to move the cursor.
- Press the left (1) and right (3) buttons located on the edge of the touchpad to do selection and execution functions. These two buttons are similar to the left and right buttons on a mouse. Tapping on the touchpad produces similar results.
- Use the 4-way scroll (2) button (top/bottom/left and right) to scroll a page up, down, left or right. This button mimics your cursor pressing on the vertical and horizontal scroll bars of Windows applications.

Function	Left Button	Right Button	Scroll Button	Tap
Execute	Click twice quickly			Tap twice (at the same speed as double-clicking the mouse button)
Select	Click once			Tap once
Drag	Click and hold, then use finger to drag the cursor on the touchpad			Tap twice (at the same speed as double-clicking a mouse button) then hold finger to the touchpad on the second tap to drag the cursor
Access context menu		Click once		
Scroll			Click and hold the button in the desired direction (up/down/left/right)	

**NOTE:** Keep your fingers dry and clean when using the touchpad. Also keep the touchpad dry and clean. The touchpad is sensitive to finger movements. Hence, the lighter the touch, the better the response. Tapping harder will not increase the touchpad's responsiveness.

## Hardware Specifications and Configurations

### Processor

Item	Specification
CPU type	Intel Pentium M 1.3GHz ~ 1.6GHz
CPU package	Micro-FCPGA
CPU core voltage	1.484V/0.956V

### BIOS

Item	Specification
BIOS vendor	Acer
BIOS Version	1.0
BIOS ROM type	Flash ROM
BIOS ROM size	512KB
BIOS package	PLCC
Supported protocols	ACPI 1.0b, APM 1.2, PC Card 95, SM BIOS 2.3, EPP/IEE 1284, ECP/IEEE 1284 1.7 & 1.9, PCI 2.2, PnP 1.0a, DMI 2.0, USB, VESA VGA BIOS, BBC-2B, CD-ROM bootable, Windows keyboard Microsoft Simple Boot Flag
BIOS password control	Set by setup manual

### Second Level Cache

Item	Specification
Cache controller	Built-in CPU
Cache size	1MB
1st level cache control	Always enabled
2st level cache control	Always enabled

### System Memory

Item	Specification
Memory controller	Intel ODEM
Onboard memory size	0MB
DIMM socket number	2 sockets
Supports memory size per socket	512MB
Supports maximum memory size	1024MB
Supports DIMM type	Synchronous DRAM
Supports DIMM Speed	133 MHz
Supports DIMM voltage	3.3V
Supports DIMM package	200-pin soDIMM
Memory module combinations	You can install memory modules in any combinations as long as they match the above specifications.

### Memory Combinations

Slot 1	Slot 2	Total Memory
0MB	128MB	128MB
0MB	256MB	256MB
0MB	512MB	512MB
0MB	1024MB	1024MB
128MB	128MB	256MB
128MB	256MB	384MB
128MB	512MB	640MB
256MB	128MB	384MB
256MB	256MB	512MB
256MB	512MB	768MB
512MB	128MB	640MB
512MB	256MB	768MB
512MB	512MB	1024MB
1024MB	1024MB	2048MB

**NOTE:** Above table lists some system memory configurations. You may combine DIMMs with various capacities to form other combinations. .

### LAN Interface

Item	Specification
Chipset	Broadcom BCM4401
Supports LAN protocol	10/100 Mbps
LAN connector type	RJ-45
LAN connector location	Right side

### Model/Bluetooth Interface

Item	Specification
Chipset	Agree Scorpio soft modem solution and CSR BC02 Bluetooth chipset
Fax modem data baud rate (bps)	14.4K
Data modem data baud rate (bps)	56K
Supports modem protocol	V.92
Modem connector type	RJ-11
Modem connector location	Right side
Bluetooth data baud rate (bps)	11Mbps

### Hard Disk Drive Interface

Item	Specification	
Vendor & Model Name	Toshiba 30G (MK3021GAS)	Fujitsu MHS2030AT
Capacity (MB)	30000	30000
Bytes per sector	512	512
Data heads	2	2
Drive Format		
Disks	1	1
Spindle speed	4200 RPM	4200 RPM

### Hard Disk Drive Interface

Item	Specification	
Performance Specifications		
Buffer size	2048KB	2048KB
Interface	ATA-2/ATA-3/ATA-4/ATA-5 support	ATA-2/ATA-3/ATA-4/ATA-5 support
Max. media transfer rate (disk-buffer, Mbytes/s)	19.2 ~ 37.25	19.4 ~ 38.1
Data transfer rate (disk-buffer, Mbytes/s)	100 MB/sec. Ultra DMA mode-5	100 MB/sec. Ultra DMA mode-5
DC Power Requirements		
Voltage tolerance	5V(DC) +/- 5%	5V(DC) +/- 5%

### DVD-ROM Interface

Item	Specification	
Vendor & model name	DVD-ROM 8X QSI SDR-083	
Performance Specification	With CD Diskette	With DVD Diskette
Transfer rate (KB/sec)	Sustained: Typical 3.6 Mbytes/sec	Sustained: Typical 10.8 Mbytes/sec
Data Buffer Capacity	512KBytes	
Interface	IDE/ATAPI	
Applicable disc format	DVD: DVD-5, DVD-9, DVD-10, DVD-R (3.95G) CD: CD-DA, CD-ROM (mode 1), CD-ROM XA (mode 2, form 1 and form 2), CD-I (mode 2, form 1 and form 2), CD-I Ready, Photo CD, Video CD, Enhanced CD, CD-TEXT, Karaoke CD, CD Plus, CD Extra, I-trax CD, CD-R and CD-RW	
Loading mechanism	Soft eject (with emergency eject hole)	
Power Requirement		
Input Voltage	+5 V +/- 5 %	



**Audio Interface**

Item	Specification
Audio Controller	Realtek ALC202A
Audio onboard or optional	Built-in
Mono or Stereo	Stereo
Resolution	20 bits digital to analog converter 18 bits analog to digital converter
Compatibility	Microsoft PC99, AC97 2.2, WLP2.0 audio requirement
Mixed sound source	Line-in, CD, Video, AUX
Voice channel	8/16-bit, mono/stereo
Sampling rate	44.1 KHz
Internal microphone	Yes
Internal speaker / Quantity	Yes/2
Supports PnP DMA channel	DMA channel 0 DMA channel 1
Supports PnP IRQ	IRQ3, IRQ5, IRQ7, IRQ9, IRQ10, IRQ11

**Video Interface**

Item	Specification
Chip vendor	ATI
Chip name	Mobility Radeon 9000
Supports ZV (Zoomed Video) port	No
Graphic interfacet	4X AGP (Accelerated Graphic Port) bus
Maximum resolution (LCD)	1600*1200
Maximum resolution (CRT)	1280*1024

**Video Memory**

Item Resolution	Specification
Fixed or upgradeable	Fixed
Video memory size	64MB

**Parallel Port**

Item	Specification
Parallel port controller	NS PC87391
Number of parallel port	1
Location	Rear side
Connector type	25-pin D-type connector, in female type
Parallel port function control	Enable/Disable/Auto by BIOS setup
Supports ECP/EPP/Bi-directional (PS/2 compatible)	Yes (set by BIOS setup)
Optional ECP DMA channel (in BIOS Setup)	DMA channel 1 and 3
Optional parallel port I/O address (in BIOS Setup)	3BCh, 278h, 378h
Optional parallel port IRQ (in BIOS Setup)	IRQ7, IRQ5

**IEEE 1394 Port**

Item	Specification
1394 controller	TI TSB43AB21
Number of 1394 port	1
Location	Left panel

**USB Port**

Item	Specification
USB Compliancy Level	2.0
OHCI	USB 2.0
Number of USB port	4
Location	Left panel
Serial port function control	Enable/Disable/Auto by BIOS Setup

**PCMCIA Slot / Smart Card**

Item	Specification
PCMCIA controller	OZ 711M1
Supports card type	Type-III/II
Number of slots	One type-III
Access location	Left side
Supports ZV (Zoomed Video)	port
Supports 32 bit CardBus	YES (IRQ10)

**System Board Major Chips**

Item	Controller
System core logic	Intel 855PM
Super I/O controller	NS PC87391
Audio controller	Realtek ALC202A
Video controller	ATI Mobility Radeon 9000
Hard disk drive controller	Intel ICH4-M
Keyboard controller	NS 87591
RTC	Intel ICH4-M

**Keyboard**

Item	Specification
Keyboard controller	NS 87591
Keyboard vendor & model name	NS
Total number of keypads	84-/85/88-key
Windows 95 keys	Yes
Internal & external keyboard work simultaneously	Yes

**Battery**

Item	Specification
Vendor & model name	Sinplo / Sanyo
Battery Type	Li-ion
Pack capacity	4400mAH
Cell voltage	3.7V/cell
Number of battery cell	8
Package configuration	4 cells in series, 2 series in parallel
Package voltage	14.8V

**LCD Inverter**

Item	Specification		
Vendor & model name	Ambit T181064.00		
Input voltage (V)	8 (min.)		20 (max.)
Input current (mA)			520 (max.)
Output voltage (Vrms, no load)		700 (typ.)	
Output voltage frequency (kHz)	50 (min.)		61 (max.)
Output Current/Lamp	lout (min.)	3.0mA / 4.0mA	Vadj = 0V
	lout (max.)	5.5mA / 6.5mA	Vadj = 3.3V

**NOTE:** DC-AC inverter is used to generate very high AC voltage, the support to LCD CCFT backlight user, and is also responsible for the control of LCD brightness. Avoid touching the DC-AC inverter area while the system is on.

**LCD**

Item	Specification	
Vendor & model name	QDI QD141X1LH12	LG LP150E02-A2P1 Hitachi TX38D81VC1CAB AU B150XG01
Mechanical Specifications		
LCD display area (diagonal, inch)	14.1	15.0
Display technology	TFT	TFT
Resolution	XGA (1024x768)	SXGA (1400X1050)
Supports color	16.7 million	16.7 million
Optical Specifications		
Brightness control	Keyboard hotkey	Keyboard hotkey
Contrast control	No	No
Suspend/Standby control	Yes	Yes
Electrical Specifications		
Supply voltage for LCD display (V)	3.3	3.3
Supply voltage for LCD backlight (Vrms)	660 (typ.)	690 (typ.)

### AC Adapter

Item	Specification
Vendor & model name	Delta 75W ADP-75FB A(WPFC) 3P Lite-on 75W PA 1750-02CA(WPFC) 3P
Input Requirements	
Maximum input current (A, @90Vac, full load)	<1.5A @ 90Vac <1.125A @ 180Vac
Nominal frequency (Hz)	47 - 63
Frequency variation range (Hz)	47 - 63
Nominal voltages (Vrms)	100 - 240
Inrush current	The maximum inrush current will be less than 75A and 188A when the adapter is connected to 100Vac(60Hz) and 240Vac(50Hz) respectively.
Efficiency	It should provide an efficiency of 83% minimum, when measured at maximum load under 115V(60Hz)
Output Ratings	
DC output voltage	+18.8V~20.0V including the effects of line voltage variation, load current, ripple and noise
Noise + Ripple	400mvp-p(20MHz bandwidth) for resistor load
Output current	0~3.95A
Input rated voltage	100/240V
Input currentt	1.5A @90Vac for Delta / 1.125A @90Vac for Lite-on
Dynamic Output Characteristics	
Turn-on delay time	3 sec.
Hold up time	5 ms min. (115Vac, input full load)
Over Voltage Protection (OVP)	29 V
Short circuit protection	Output can be shorted without damage
Electrostatic discharge (ESD)	+/- 15kV (at air discharge) +/- 8kV (at contact discharge)
Dielectric Withstand Voltage	
Primary to secondary	3000Vac (4242Vdc) 10mA for 1 second
Leakage current	100uA max (240Vac, 60Hz)
Regulatory Requirements	Internal filter meets: 1. FCC class B requirements 2. VDE 243/1991 class B requirements 3. CISPR 22 class B requirements 4. VCCI class II requirements

### Power Management

Power Saving Mode	Phenomenon
<p><b>Standby Mode</b> Waiting time specified by the System Standby value or the operating system elapses without any system activity. Or When the computer is about to enter Hibernation mode (e.g. during a battery-low condition), but the Hibernation file is invalid or not present.</p>	The Sleep indicator lights up

Power Saving Mode	Phenomenon
<b>Hibernation Mode</b> When customized functions for power management are set to Hibernation and the corresponding action is taken.	All power shuts off
<b>Display Standby Mode</b> Keyboard, built-in touchpad, and an external PS/2 pointing device are idle for a specified period.	The display shuts off
<b>Hard Disk Standby Mode</b> Hard disk is idle within a specified period of time	Hard disk drive is in standby mode. (spindle turned-off)

### Environmental Requirements

Item	Specification
Temperature	
Operating	0 ~ +40°C
Non-operating	-20 ~ +60°C(unpacked)
Non-operating	Non (storage package)
Humidity	
Operating	0% to 90% RH, non-condensing
Non-operating	20% to 90% RH, non-condensing (unpacked)
Non-operating	Non (storage package)
Vibration	
Operating (unpacked)	5~500Hz: 1.0Grms (random)
Non-operating (unpacked)	5~500Hz: 2.16Grms (random)
Non-operating (packed)	5~500Hz: 2.16Grms (random)

### Mechanical Specification

Item	Specification
Dimensions	320 (W) x 262 (D) x 34 (H) for 14.1 inch model; 320 (W) x 267 (D) x 35 (H) for 15.0 inch mode
Weight	2.9Kg (6.4 lbs) for 14.1 inch model; 3.1Kg (6.8 lbs) for 15.0 inch model
I/O Ports	4 USB ports, 1 VGA (external monitor) port, 1 microphone-in jack, 1 headphone-out jack, 1 Line-in jack, 1 RJ-11 modem jack, 1 RJ-45 Ethernet jack, 1 PCMCIA (type II or type III) slot, 1 parallel port (ECP/ EPP compliant), 1 DC-in jack for AC adapter, 1 easy replicator port, 1 1394 port, 1 Smart Card slot, and 1 TV-out port
Drive Bays	One
Material	Plastic
Indicators	Power Mode LED, Battery Charge LED, Caps Lock, Num Lock, Media Activity LED, Bluetooth Activity and Wireless LAN Activity
Switch	Power

### Memory Address Map

Memory Address	Size	Function
00100000h-000F0000h	512 KB	System BIOS
000CD000h-000C0000h		VGA BIOS
000C0000h-000A0000h	128 KB	Video memory (VRAM)
000A0000h-00000000h	640KB	Conventional memory

**I/O Address Map**

I/O Address	Function
000-00F	DMA controller-1
020-021	Interrupt controller-1
040-043	Timer 1
060, 064	Keyboard controller 38859 chip select
061	System speaker out
040B	DMA controller-1
061	System speaker
070-073	Real-time clock and NMI mask
080-08F	DMA page register
0A0-0A1	Interrupt controller-2
0C0-0DF	DMA controller-2
66, 62	Power management controller
0F0-0FF	Numeric data processor
170-177	2nd EIDE device (CD-ROM) select
1F0-1F7	1st EIDE device (hard drive) select
220-22F	Audio
240-24F	Audio (optional)
278-27F	Parallel port 3
378,37A	Parallel port 1
3B0-3BB 3C0-3DF	Video Controller
3F0h-3F7	Standard Floppy Disk Controller
3F0-3F7	Floppy disk controller
480-48F, 4D6	DMA controller-1
4D0-4D1 CF8-CFF	PCI configuration register

**IRQ Assignment Map**

Interrupt Channel	Function(Hardware)
IRQ00	System Timer
IRQ01	Keyboard
IRQ03	IrDA Fast Infrared Port
IRQ04	Communications Port (COM1)
IRQ05	LAN, USB
IRQ06	Free
IRQ07	Free
IRQ08	System CMOS / realtime clock
IRQ09	SCI IRQ used by ACPI bus, Wireless LAN
IRQ10	USB, Modem, VGA, MultiMedia Bay, 1394, Audio
IRQ11	O2 Micro Smart CardBus Reader
IRQ12	Synaptics PS/2 port pointing device
IRQ13	Numeric data processor
IRQ14	1st EIDE device (hard disk)
IRQ15	2nd EIDE device (CD-ROM drive)

---

**DMA Channel Assignment**

DMA Channel	Function (Hardware)
DRQ0	Reserved
DRQ1	IrDA Fast Infrared Port
DRQ2	Reserved
DRQ3	ECP printer port (LPT1)
DRQ4	DMA controller
DRQ5	Reserved
DRQ6	Reserved
DRQ7	Reserved





# System Utilities

## BIOS Setup Utility

The BIOS Setup Utility is a hardware configuration program built into your computer's BIOS (Basic Input/Output System).

Your computer is already properly configured and optimized, and you do not need to run this utility. However, if you encounter configuration problems, you may need to run Setup. Please also refer to Chapter 4 Troubleshooting when problem arises.

The setup function can only be invoked by pressing F2 when <sup>2</sup> Press <F2> to enter Setup<sup>2</sup> message is prompted on the bottom of screen during POST.

PhoenixBIOS Setup Utility					
Info.	Main	System Devices	Security	Boot	Exit
CPU Type		Mobile Genuine Intel® processor		1600MHz	
CPU Speed		1600 MHz			
HDD1 Model Name		TOSHIBA MK4021GAS			
HDD1 Serial Number		X2NC0053T			
HDD2 Model Name					
HDD2 Serial Number					
ATAPI Device		QSI DVD-ROM SDR-083			
System BIOS Ver:		2A05			
VGA BIOS Ver:		ATI M9 008.006.009			
KBC Ver:		PQ1A24			
Serial Num:					
Asset Tag Number:					
Product Name:		TravelMate 800			
Manufacturer Name:		Acer			
UUID:		FFFFFFFFFFFFFFFFFFFFFFFFFFFFFFFF			
F1 Help    ↑↓ Select Item    F5/F6 Change Values    F9 Setup defaults Esc Exit    ← → Select Menu    Enter Select ▶ Sub-Menu    F10 Save and Exit					

---

## Navigating the BIOS Utility

There are six menu options: Info., Main, System Devices, Security, Boot, and Exit.

Follow these instructions:

- To choose a menu, use the cursor left/right keys.
- To choose a parameter, use the cursor up/down keys.
- To change the value of a parameter, press F5 or F6.
- A plus sign (+) indicates the item has sub-items. Press Enter to expand this item.
- Press Esc while you are in any of the menu options to go to the Exit menu.
- In any menu, you can load default settings by pressing F9. You can also press F10 to save any changes made and exit the BIOS Setup Utility.

**NOTE:** You can change the value of a parameter if it is enclosed in square brackets. Navigation keys for a particular menu are shown on the bottom of the screen. Help for parameters are found in the Item Specific Help part of the screen. Read this carefully when making changes to parameter values.

This menu provides you the information of the system.

## Info.

PhoenixBIOS Setup Utility					
Info.	Main	System Devices	Security	Boot	Exit
CPU Type		Mobile Genuine Intel® processor		1600MHz	
CPU Speed		1600 MHz			
HDD1 Model Name		TOSHIBA MK4021GAS			
HDD1 Serial Number		X2NC0053T			
HDD2 Model Name					
HDD2 Serial Number					
ATAPI Device		QSI DVD-ROM SDR-083			
System BIOS Ver:		2A05			
VGA BIOS Ver:		ATI M9 008.006.009			
KBC Ver:		PQ1A24			
Serial Num:					
Asset Tag Number:					
Product Name:		TravelMate 800			
Manufacturer Name:		Acer			
UUID:		FFFFFFFFFFFFFFFFFFFFFFFFFFFF			
F1 Help    ↑↓ Select Item    F5:F6 Change Values    F9 Setup defaults Esc Exit    ← → Select Menu    Enter Select ▸ Sub-Menu    F10 Save and Exit					

Parameter	Description
IDE1 Model Name	Shows the Model name of HDD installed on Primary IDE master. The hard disk model name is automatically detected by the system. If there is no hard disk present or unknown type, "None" should be shown on this field.
IDE1 Serial Number	Shows the Serial number of HDD installed on Primary IDE master. If no Hard disk or other devices are installed on Primary IDE master, then it will display a blank line.
Serial Number	This field displays the serial number of this unit
UUID Number	UUID=32bytes, visible when an internal LAN device is present

## Main

The Main screen displays a summary of your computer hardware information, and also includes basic setup parameters. It allows the user to specify standard IBM PC AT system parameters.

PhoenixBIOS Setup Utility		
Info.	Main	System Devices Security Boot Exit
		Item specific Help
System Time:	[09:00:00]	
System Date:	[02/01/2003]	<Tab>, <Shift-Tab>, or <Enter> selects field.
System Memory:	640 KB	
Extended Memory:	510 MB	
VGA Memory:	64MB	
Fast Boot:	[Enabled]	
Power on display:	[Auto ]	
LCD Auto Dim:	[Enabled]	
F1 Help	↑↓ Select Item	F5/F6 Change Values F9 Setup defaults
Esc Exit	← → Select Menu	Enter Select ▸ Sub-Menu F10 Save and Exit

**NOTE:** The screen above is for reference only. Actual values may differ.

The table below describes the parameters in this screen. Settings in **boldface** are the default and suggested parameter settings.

Parameter	Description	Format/Option
System Time	Sets the system time.	Format: HH:MM:SS (hour:minute:second) System Time
System Date	Sets the system date.	Format MM/DD/YYYY (month/day/ year) System Date
System Memory	This field reports the memory size of the system. Memory size is fixed to 640MB	
Extended Memory	This field reports the memory size of the extended memory in the system. Extended Memory size=Total memory size-1MB	
Video Memory	This field reports the VGA memory size of the system. Memory size is fixed to 64MB.	
Fast Boot	Determines if Customer Logo will be displayed or not; shows Summary Screen is disabled or enabled.  Enabled: Customer Logo is displayed, and Summary Screen is disabled. Disabled: Customer Logo is not displayed, and Summary Screen is enabled.	Option: <b>Enabled</b> or Disabled
Power on display	Auto: During power on process, the system will detect if any display device is connected on external video port. If any external display device is connected, the power on display will be in CRT (or projector) only mode. Otherwise it will be in LCD only mode.  Both: Simultaneously enable both the integrated LCD screen and the system's external video port (for an external CRT or projector).	Enabled or Disabled
LCD Auto Dim	Determines if the system will automatically dim the LCD brightness in order to save power when AC is not present.	Option: <b>Enabled</b> or Disabled

**NOTE:** The sub-items under each device will not be shown if the device control is set to disable or auto. This is because the user is not allowed to control the settings in these cases.

## System Devices

The System Devices screen contains parameters involving your hardware devices. It also provides advanced settings of the system.

PhoenixBIOS Setup Utility		
Info.	Main	System Devices
		Item specific Help
Serial Port:	[Auto]	
Parallel Port:	[Enabled]	Configure serial port using options:
Mode:	[ECP]	[Disabled]
Base I/O address:	[378]	No configuration
Interrupt:	[IRQ 7]	[Enabled]
DMA channel:	[DMA 3]	User configuration
Television Type:	[NTSC]	[Auto]
PS/2 Mouse:	[Auto Detect]	BIOS or OS chooses configuration
Infrared Port(FIR) :	[Enabled]	
<b>F1 Help    ↑↓ Select Item    F5/F6 Change Values    F9 Setup defaults</b>		
<b>Esc Exit    ← → Select Menu    Enter Select ▸ Sub-Menu    F10 Save and Exit</b>		

The table below describes the parameters in the screen. Settings in **boldface** are the default and suggested parameter settings.

Parameter	Description	Options
Serial Port	Enables, disables or auto detects the serial port	Disabled/Enabled/Auto
Parallel Port	Enables, disables or auto detects the parallel port	Disabled/Enabled/Auto
Mode	Sets the operation mode if the parallel port	Normal/Bi-directional/ECP/EPP
Base I/O address	Set the base I/O address for the parallel port.	378h/278h/3BCh
Interrupt	Set the interrupt for the parallel port	IRQ 5/IRQ 7
DMA channel	Set the DMA channel for the parallel port	DMA 1/DMA 3
Television type	Select TV standard	NTSC/PAL
PS/2 Mouse	Enables, disables or auto detects the PS/2 mouse	Disabled/Enabled/Auto Detect
Infrared Port (FIR)	Enables, disables or auto detects the infrared port	Disabled/Enabled/Auto

## Security

The Security screen contains parameters that help safeguard and protect your computer from unauthorized use.

PhoenixBIOS Setup Utility					
Info.	Main	System Devices	<b>Security</b>	Boot	Exit
				Item specific Help	
	User Password is	Clear			
	Supervisor Password is	Clear			
	HDD Password is	Clear			
	HDD Master ID	xxxxxxxx			
	Set User Password	[Enter]			
	Set Supervisor Password	[Enter]		Supervisor Password controls access to the setup utility	
	Set HDD Password	[Enter]			
	Password on Boot:	[Enabled]			
F1 Help    ↑↓ Select Item    F5/F6 Change Values    F9 Setup defaults Esc Exit    ← → Select Menu    Enter Select ▸ Sub-Menu    F10 Save and Exit					

The table below describes the parameters in this screen. Settings in **boldface** are the default and suggested parameter settings.

Parameter	Description	Option
User Password is	Shows the setting of the user password.	<b>Clear</b> or Set
Supervisor Password is	Shows the setting of the administrator password	<b>Clear</b> or Set
<b>HDD Password is</b>		
<b>HDD Master ID</b>		
Set User Password	Press Enter to set the user password. When set, this password protects the BIOS Setup Utility from unauthorized access.	
Set Supervisor Password	Press Enter to set the administrator password. When set, this password protects the BIOS Setup Utility from unauthorized access.	
<b>Set HDD Password</b>		
Password on boot	Allows the user to specify whether or not a password is required to boot.	<b>Disabled</b> or Enabled

**NOTE:** When you are prompted to enter a password, you have three tries before the system halts. Don't forget your password. If you forget your password, you may have to return your notebook computer to your dealer to reset it.

### Set User Password / Set Supervisor Password

Follow these steps as you set the user or the supervisor password:

1. Move the cursor and highlight the Set Supervisor Password and press “**Enter**”, a window similar to the following is shown:

Set Supervisor Password

Enter New Password [                    ]

Confirm New Password [                    ]

2. Type a password in field “**Enter New Password**”. The password length can not exceeds 8 alphanumeric characters (0-9 or A-Z / a-z, not case sensitive). Re-enter password in field “**Confirm New Password**” for verification.
3. If the verification is OK, a window similar to the following is shown, press enter to complete.

Setup Notice

Changes have been saved.

[ continue ]

After setting the password, the computer sets the Password parameter to "Set".

4. If desired, you can opt to enable the Password on boot parameter.
5. When you are done, press F10 to save the changes and exit the BIOS Setup Utility.

**IMPORTANT:** Be very careful when typing your password because the characters do not appear on the screen.

If the current password entered does not match the actual current password:

Setup Warning

Invalid password

Re-enter Password

[ continue ]

If the new password and confirm new password strings do not match:

Setup Warning

Password do not match

Re-enter Password



## Removing a Password

Follow these steps:

1. Move the cursor and highlight the Set Supervisor Password and press **"Enter"**, a window similar to the following is shown:

Set Supervisor Password		
Enter current password	[	]
Enter New Password	[	]
Confirm New Password	[	]

2. Type the current password in the Enter Current Password field and press **"Enter"**.
3. Press **"Enter"** twice **without** typing anything in the Enter Password and Confirm New Password fields. The computer then sets the Supervisor Password parameter to "Clear".
4. When you have changed the settings, press F10 to save the changes and exit the BIOS Setup Utility.

## Changing a Password

1. Move the cursor and highlight the Set Supervisor Password and press **"Enter"**, a window similar to the following is shown:

Set Supervisor Password		
Enter current password	[	]
Enter New Password	[	]
Confirm New Password	[	]

2. Type the current password in the Enter Current Password field and press **"Enter"**.
3. Type a password in the Enter New Password field. Retype the password in the Confirm New Password field.
4. Press **"Enter"** to complete password setting. After setting the password, the computer sets the Password parameter to "Set".
5. If desired, you can opt to enable the Password on boot parameter.
6. When you are done, press F10 to save the changes and exit the BIOS Setup Utility.

## Primary Harddisk Security

This feature is available to user when Supervisor password is set. Password can be written on HDD only when Supervisor password or user password is set and password on HDD is set to enabled. Supervisor Password is written to HDD when only Supervisor password is being set. User password is written to HDD when both passwords are set. When both Supervisor and user passwords are present, both passwords can unlock the HDD.

## Boot

This menu allows the user to decide the order of boot devices to load the operating system. Bootable devices includes the distette drive in module bay, the onboard hard disk drive and the CD-ROM in module bay.

PhoenixBIOS Setup Utility			
Info.	Main	System Devices	Security <b>Boot</b> Exit
			Item specific Help
	+Hard Drive		+ and – indicate device categories. Use <Enter> to expand/collapse.
	CD-ROM/DVD-ROM		
	Removable Device		
	Boot to LAN		
			Boot order is top-down using only the top device in each category.
			Use <F6> and <F5> to move highlighted item up and down.
F1	Help	↑↓ Select Item	F5:F6 Change Values F9 Setup defaults
Esc	Exit	← → Select Menu	Enter Select ▸ Sub-Menu F10 Save and Exit

## Exit

The Exit screen contains parameters that help safeguard and protect your computer from unauthorized use.

PhoenixBIOS Setup Utility		
Info.	Main	System Devices Security Boot Exit
		Item specific Help
	Exit Saving Changes	Exit System Setup and save your changes to CMOS
	Exit Discarding Changes	Exit utility without saving Setup data to CMOS.
	Load Setup Defaults	Load default values for all SETUP item.
	Discard changes	Load previous values from CMOS for all SETUP items
	Save changes	Save Setup Data to CMOS
F1 Help	↑↓ Select Item	F5/F6 Change Values F9 Setup defaults
Esc Exit	← → Select Menu	Enter Select ▸ Sub-Menu F10 Save and Exit

The table below describes the parameters in this screen.

Parameter	Description
Exit Saving Changes	Exit System Setup and save your changes to CMOS.
Exit Discarding Changes	Exit utility without saving setup data to CMOS.
Load Setup Default	Load default values for all SETUP item.
Discard Changes	Load previous values from CMOS for all SETUP items.
Save Changes	Save Setup Data to CMOS.

---

## BIOS Flash Utility

The BIOS flash memory update is required for the following conditions:

- New versions of system programs
- New features or options
- Restore a BIOS when it becomes corrupted.

Use the Flash utility to update the system BIOS flash ROM.

**NOTE:** If you do not have a crisis recovery diskette at hand, then you should create a **Crisis Recovery Diskette** before you use the Flash utility.

**NOTE:** Do not install memory-related drivers (XMS, EMS, DPMS) when you use the Flash.

**NOTE:** Please use the AC adaptor power supply when you run the Flash utility. If the battery pack does not contain enough power to finish BIOS flash, you may not boot the system because the BIOS is not completely loaded.

Follow the steps below to run the Flash.

1. Prepare a bootable diskette.
2. Copy the Phlash utilities to the bootable diskette.
3. Then boot the system from the bootable diskette. The Flash utility has auto-execution function.

---

## System Diagnostic Diskette

This diagnostic diskette is for the Acer TravelMate 800 series notebook machine. You can find the utility in Service CD kit. To use the diagnostic programs, first create a bootable diskette. Extract the diagnostic utility to the bootable diskette. Then boot the system from the bootable (with diagnostic utility) diskette you create.

This program contains a readme.txt file. This readme.txt file will introduce each test utility and its functions.

New added description. Please pay attention to it. The diagnostics program we use for TravelMate 800 series is not exactly the same as PQA (Product Quality Assurance), the diagnostic program we used to employ in other model. The system diagnostic utilities is provided by Acer Headquarters. You can utilize it as a basic diagnostic tool. To get this program, find it in the TravelMate 800 series service CD kit. To better fit local service requirements, your regional office MAY have other diagnostic program. Please contact your regional offices or the responsible personnel/channel to provide you with further technical details.



## Machine Disassembly and Replacement

---

This chapter contains step-by-step procedures on how to disassemble the notebook computer for maintenance and troubleshooting.

To disassemble the computer, you need the following tools:

- Wrist grounding strap and conductive mat for preventing electrostatic discharge
- Small Philips screw driver
- Philips screw driver
- Flat head screwdriver
- Plastic flat head screwdriver
- Tweezers
- Hex driver

**NOTE:** The screws for the different components vary in size. During the disassembly process, group the screws with the corresponding components to avoid mismatch when putting back the components. When you remove the stripe cover, please be careful not to scrape the cover.

---

## General Information

### Before You Begin

Before proceeding with the disassembly procedure, make sure that you do the following:

1. Turn off the power to the system and all peripherals.
2. Unplug the AC adapter and all power and signal cables from the system.
3. Remove the battery pack.

**NOTE:** TravelMate 800 series product uses mylar or tape to fasten the FFC/FPC/connectors/cable, you may need to tear the tape or mylar before you disconnect different FFC/FPC/connectors.



## Disassembly Procedure Flowchart

The flowchart on the succeeding page gives you a graphic representation on the entire disassembly sequence and instructs you on the components that need to be removed during servicing. For example, if you want to remove the system board, you must first remove the keyboard, then disassemble the inside assembly frame in that order.

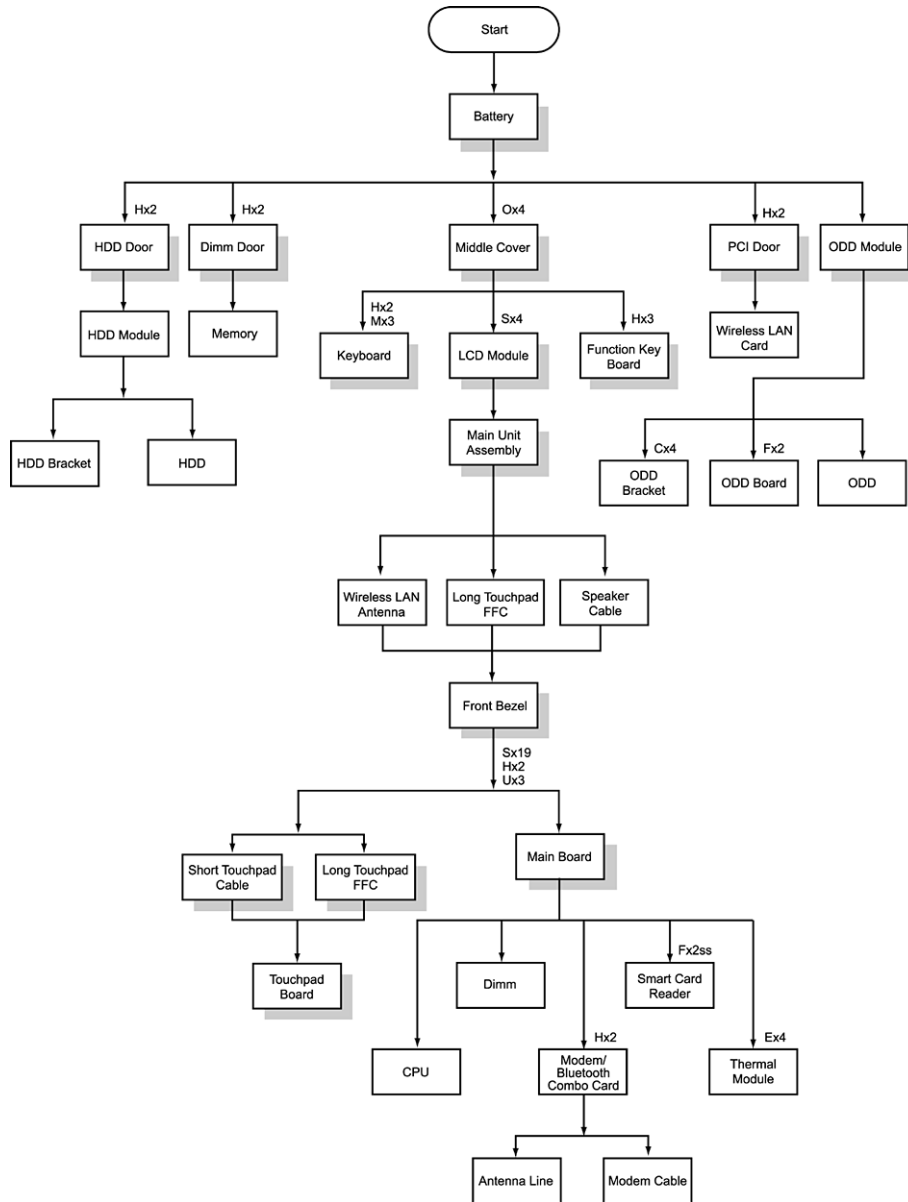

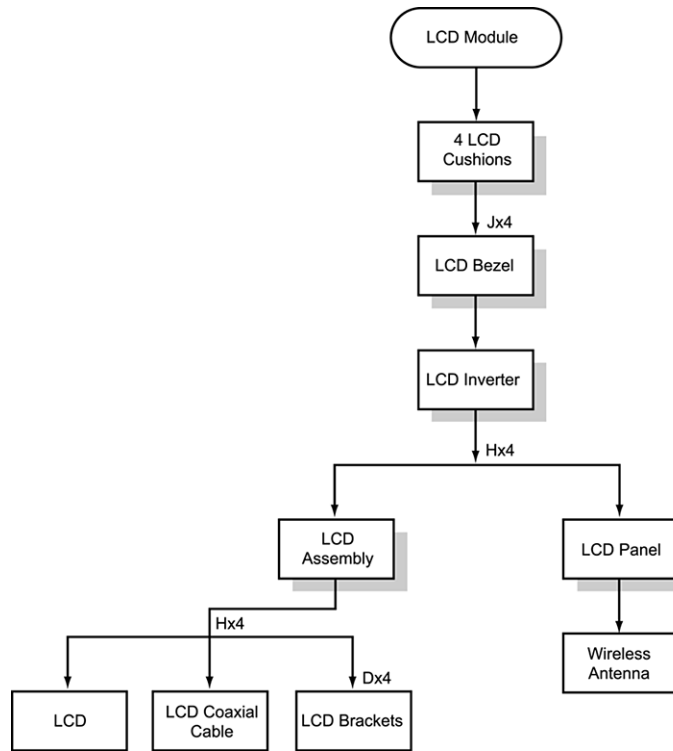

**Screw List**

Item	Description
A	SCREW NUT IO
B	SCREW CPU NUT ZG1S(MBZG1001,REV3A)
C	SCREW I3*3.5M-NIH(M3L3.5)
D	SCREW M2.0X2.5-I-NI-NYLOK
E	SCREW I2*3M-NIHY (M2L3)
F	SCREW M2.5X5.0-I-NI-NYLOK
G	SCREW I2.5*2.5M-BNIH(4.5,0.8)
H	SCREW M2.5X3-I-NI-NYLOK
I	SCREW I2.5*3M-BNIH(M2.5L3)
J	SCREW I2.5*4M-BKAGHY(M2.5L4)
K	SCREW M2.5*5-I(BNI)(NYLOK)
L	SCREW I2.5*6M-BNIHY(M2.5L6 I)
M	SCREW M2.5*7-I(NI,NYLOK)
N	SCREW M1.7X3.5-I-BZN
O	SCREW M2X3-I-BNI-NYLOK
P	SCREW BI2*5TA-BNIH(4,0.6)
Q	SCREW I2*6M-NIHY(3.5,0.4)

---

## Removing the Battery Pack

1. Press the battery lock and slide the battery latch.
2. Then remove the battery pack.



## Removing the ODD Module / HDD Module / Memory / Wireless LAN card

### Removing the ODD Module

1. Slide the optical disk drive latch and remove the optical disk drive.



### Removing the HDD Module

1. Unscrew the 2 screws as shown.
2. Remove the hard disk drive door.
3. Remove the hard disk drive module.



### Removing the Wireless LAN Card

1. Unscrew the 1 screw that secures the mini PCI door.
2. Remove the mini PCI door.
3. Disconnect the right and the left wireless Lan antenna lines.
4. Pop out and remove the wireless Lan card.

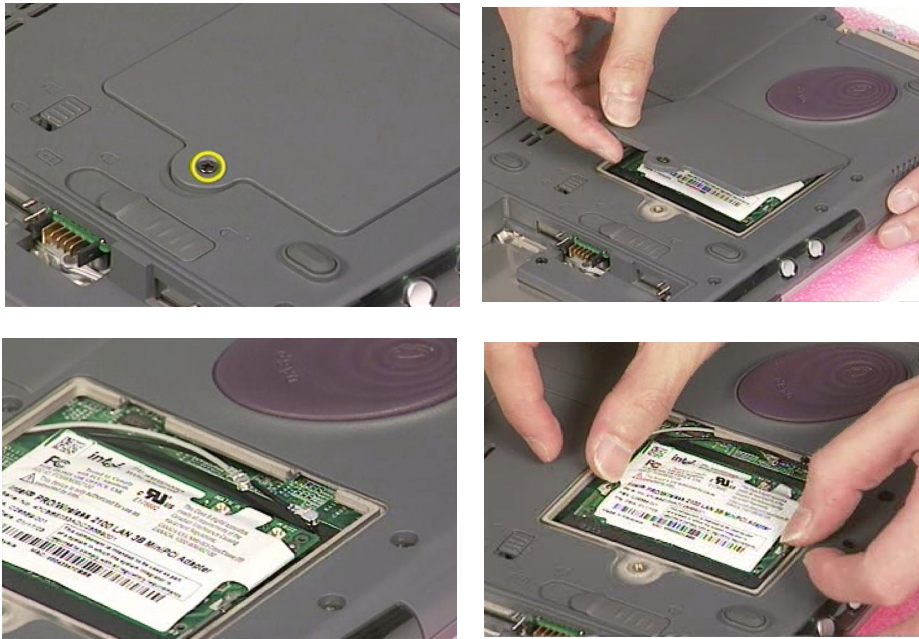

### Removing the Memory

1. Unscrew the 1 screw that secures the Dimm door.
2. Remove the Dimm door.

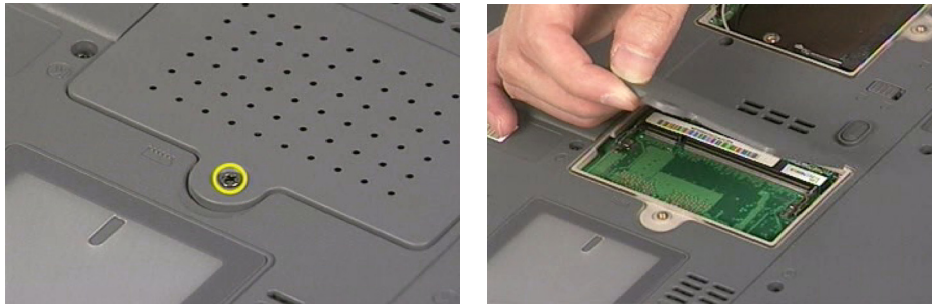

### Removing the LCD Module / Keyboard / Function Keyboard

#### Removing the LCD Module

1. Remove the middle cover as shown.
2. Disconnect the LCD cable.
3. Unscrew the 2 screws that secure the LCD module on one side.
4. Then unscrew the other 2 screws on the other side.
5. Remove the entire LCD module.

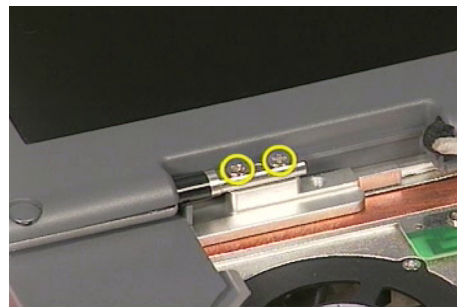
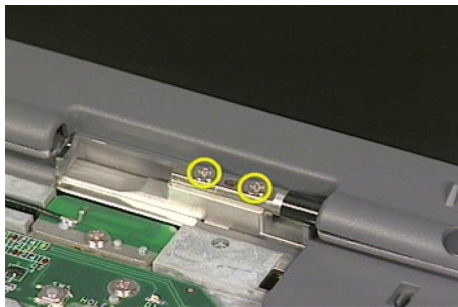
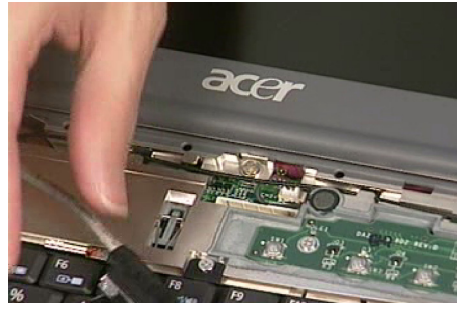
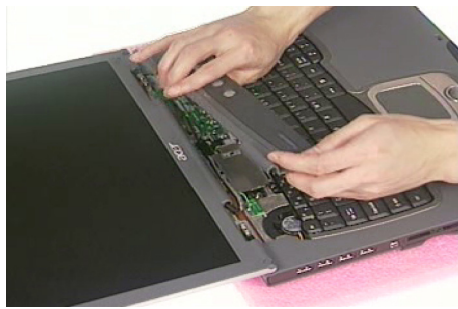

### Removing the Keyboard

1. Unscrew the 2 screws, marked as "K", on the bottom panel holding the keyboard.
2. Turn the main unit over and unscrew 3 screws on the front panel.
3. Disconnect the keyboard cable from the main board as shown.

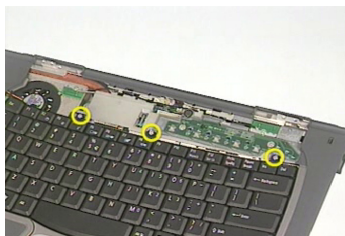
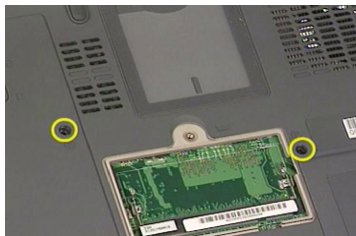

## Removing the Function Keyboard

1. Unscrew 2 screws that secure the function keyboard.
2. Then remove function keyboard from the main unit.

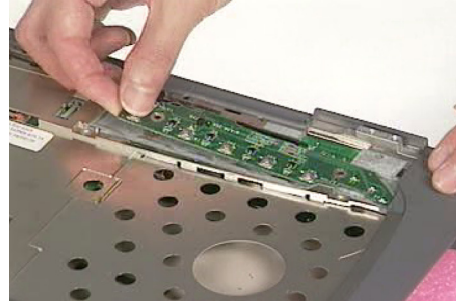
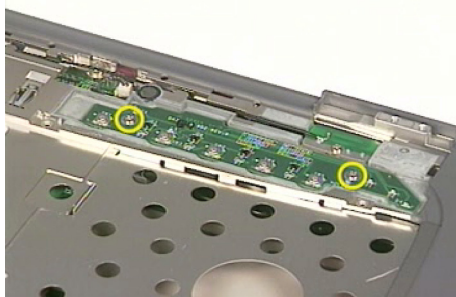

## Disassembling the Main Unit

1. Disconnect the long touchpad FFC from the main board.

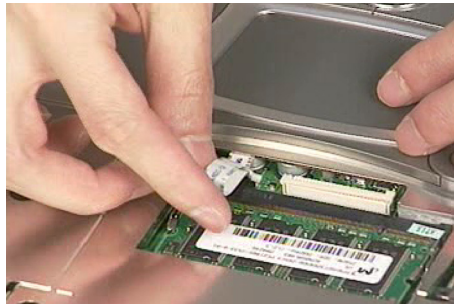

2. Unscrew the 1 screw and detach the right wireless LAN antenna as shown.

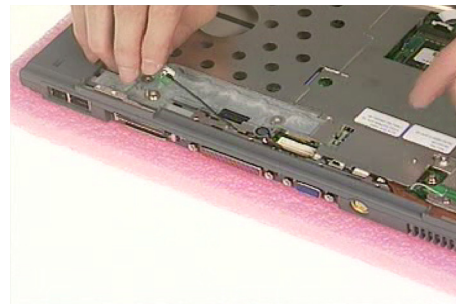
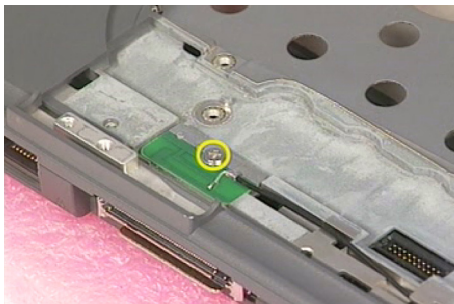

3. Then unscrew the other screw and detach the left wireless LAN antenna.

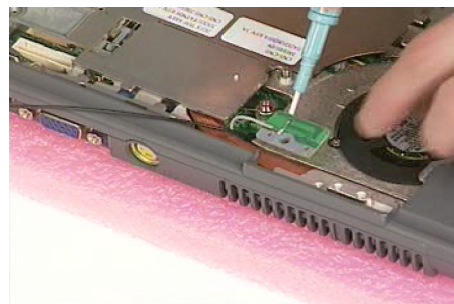
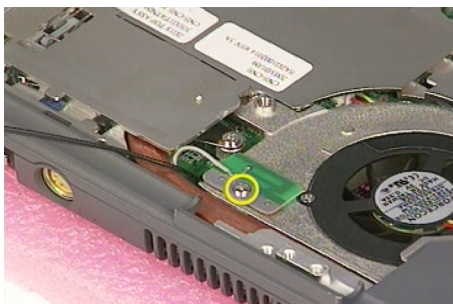

4. Disconnect the speaker cable.
5. Unscrew 19 screws on the bottom panel as shown.
6. Turn the main unit over and remove the 1 screw on the front panel.
7. Remove the top cover lens.
8. Detach the front bezel off the main unit.

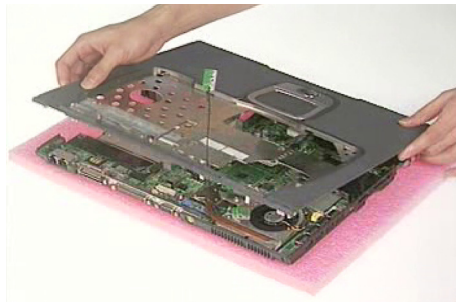
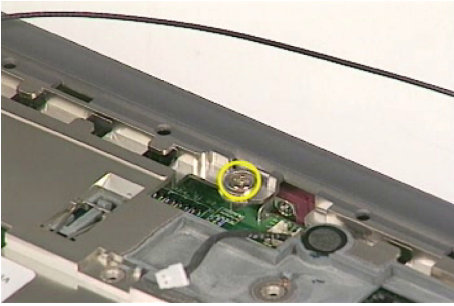
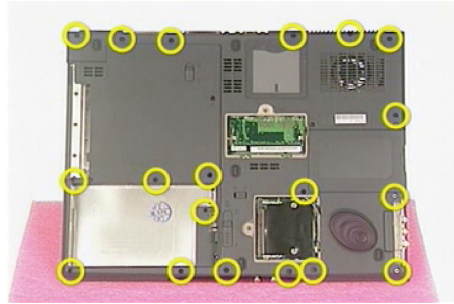
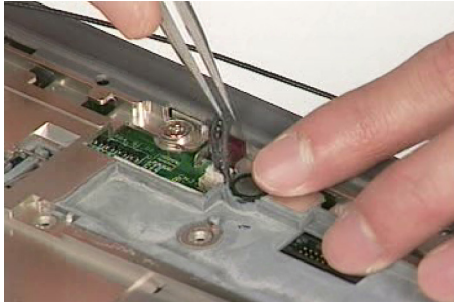



## Removing the Touchpad

1. Disconnect the short touchpad cable from the touchpad board.
2. Disconnect the long touchpad FFC from touchpad board.

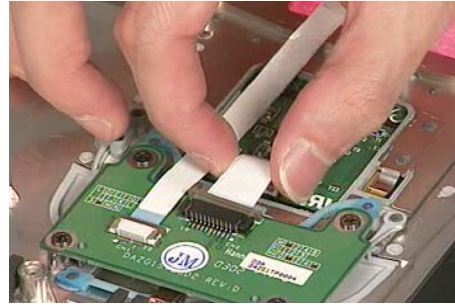
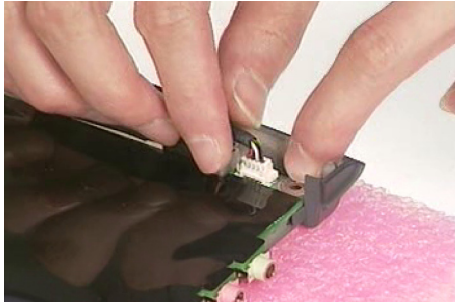

3. Unscrew four screws and remove the touchpad board.

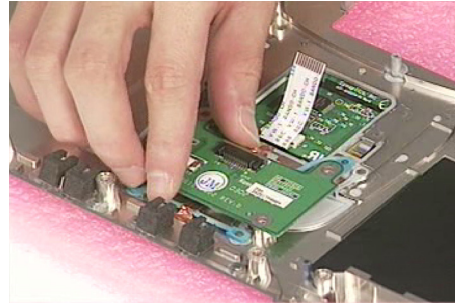
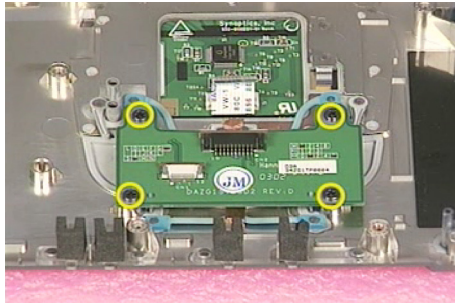

4. Disconnect and remove the short touchpad cable as shown.

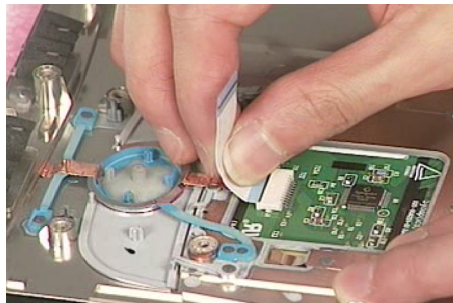

## Removing the Memory

1. Pop up and remove the memory.

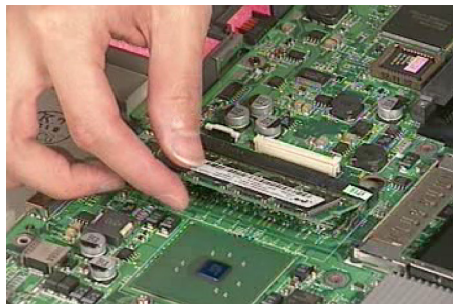

## Removing the Thermal Module

1. Disconnect the fan connector.
2. Unscrew five screws that secure the thermal module.
3. Remove the thermal module.

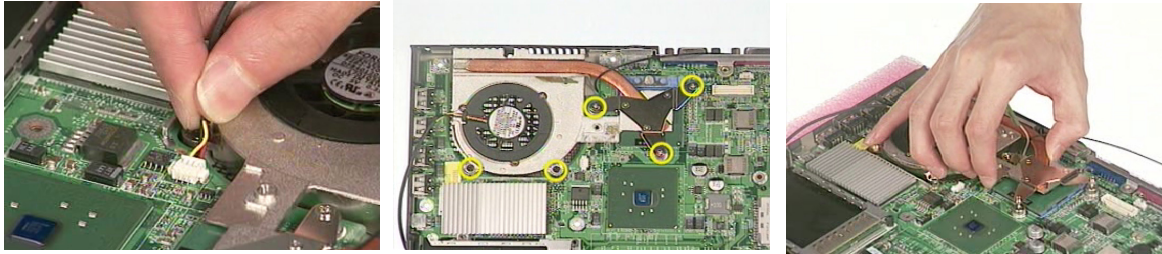

## Removing the CPU

1. Turn the CPU lock anti-clockwise with a flat screwdriver as shown.
2. Remove the CPU from the main board.

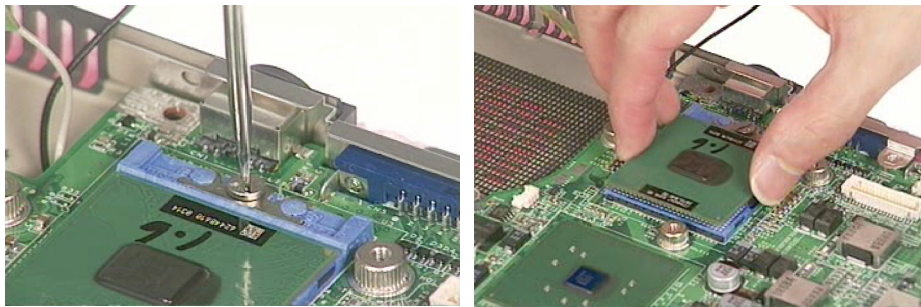

## Removing the Main Board

1. Disconnect the microphone cable.
2. Unscrew 2 screws that secure the main board.
3. Carefully remove the main board.

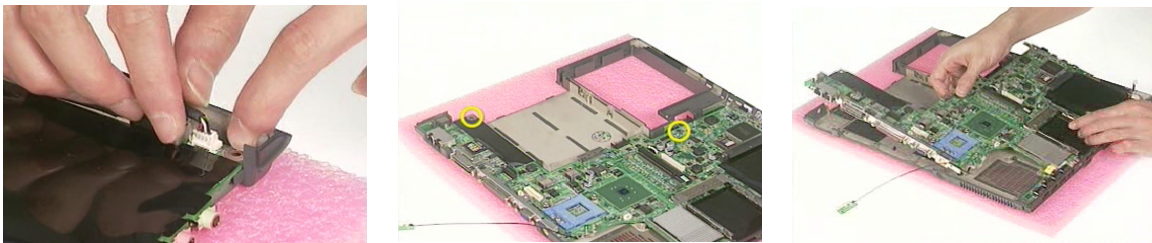

## Removing the Modem / Bluetooth Card

1. Unscrew 2 screws that secure the modem/bluetooth combo card.
2. Remove the modem/bluetooth combo card and disconnect the connector as shown.
3. Disconnect the bluetooth antenna and modem cable from the modem/bluetooth combo card.

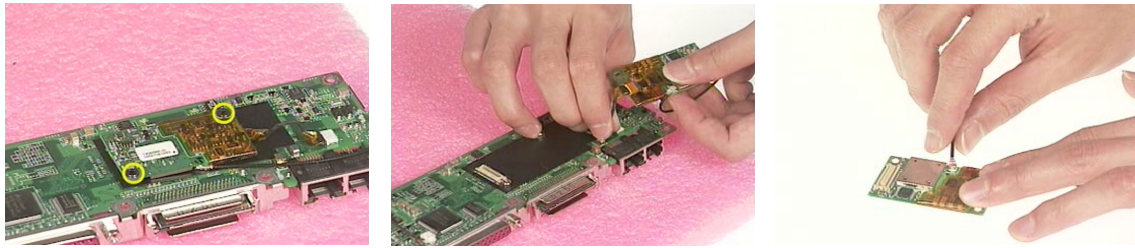

## Disassembling the LCD Module

1. Remove 4 screw pads as shown.
2. Unscrew the 4 screws holding the LCD bezel.
3. Detach LCD bezel carefully from LCD module as shown.
4. Disconnect LCD inverter from the LCD module cautiously.
5. Unscrew 10 screws holding the LCD brackets to the LCD panel, 5 on each side.

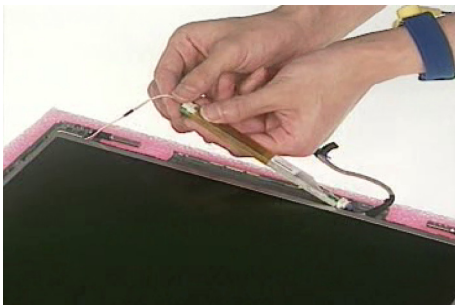

6. Take LCD out of LCD panel.



7. Unscrew 4 screws holding the right and the left LCD brackets, 2 on each side.
8. Remove the right and the left LCD brackets as shown.
9. Tear off electric conductive tape that secures the LCD wire, and disconnect the LCD wire.

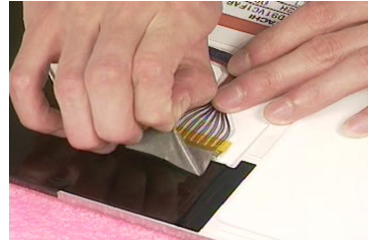

## Disassembling External Modules

### Disassembling the ODD Module

1. Remove 6 screws that secure the ODD module as shown.

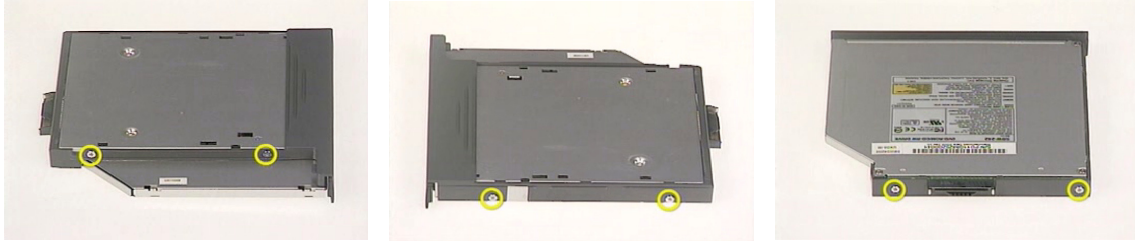

2. Slide the optical disk drive out off the ODD bracket.
3. Remove the ODD board from the ODD bracket.
4. Use a pin to press the emergency eject slot to open the ODD as shown.
5. Unscrew the 1 screw holding the ODD door.
6. Remove the ODD door.

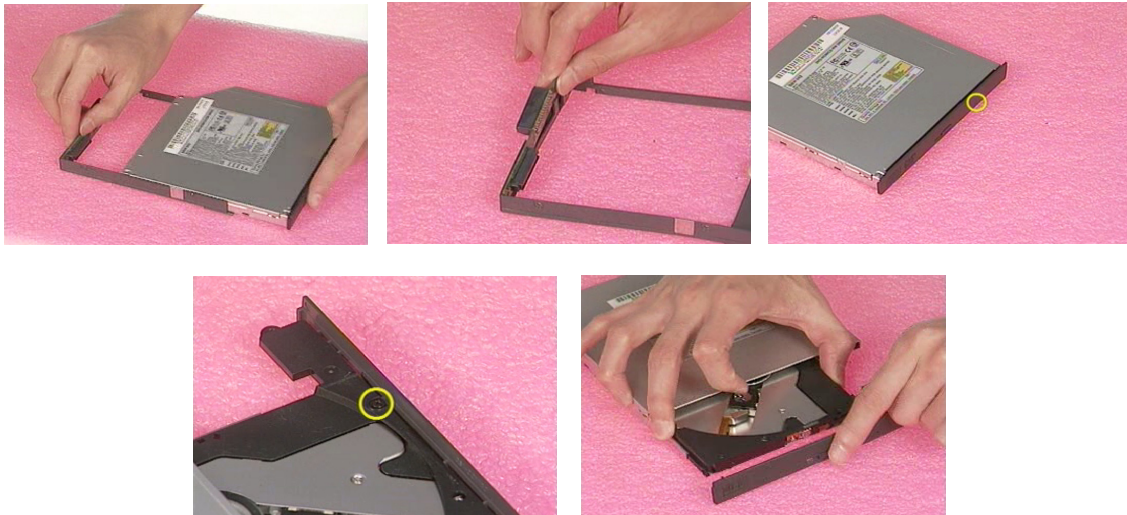

### Disassembling the HDD Module

1. Remove 4 screws holding the HDD bracket.
2. Take out the hard disk drive.

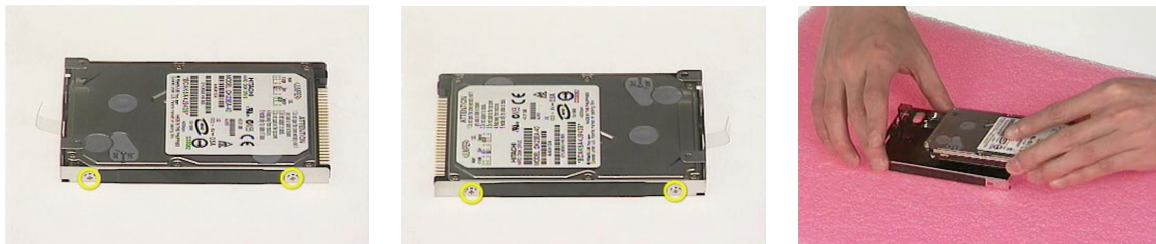



## Troubleshooting

Use the following procedure as a guide for computer problems.

**NOTE:** The diagnostic tests are intended to test this model (TravelMate 800 series). Non-Acer products, prototype cards, or modified options can give false errors and invalid system responses.

1. Obtain the failed symptoms in as much detail as possible.
2. Verify the symptoms by attempting to re-create the failure by running the diagnostic test or by repeating the same operation.
3. If any problem occurs, you can perform visual inspection before you follow this chapter's instructions. You can check the following:
  - power cords are properly connected and secured;
  - there are no obvious shorts or opens;
  - there are no obviously burned or heated components;
  - all components appear normal.
4. After you perform visual inspection you can also verify the following:
  - ask the user if a password is registered and, if it is, ask him or her to enter the password.
  - verify with the customer that Windows XP is installed on the hard disk. Operating systems that were not preinstalled by Acer can cause malfunction.
  - make sure all optional equipment is removed from the computer.
  - make sure the floppy disk is empty.
5. Use the following table with the verified symptom to determine which page to go to.

Symptoms (Verified)	Go To
Power failure. (The power indicator does not go on or stay on.)	"Power System Check" on page 65.
POST does not complete. No beep or error codes are indicated.	"Power-On Self-Test (POST) Error Message" on page 69 "Undetermined Problems" on page 76
POST detects an error and displayed messages on screen.	"Error Message List" on page 70
The diagnostic test detected an error and displayed a FRU code.	"System Diagnostic Diskette" on page 45
Other symptoms (i.e. LCD display problems or others).	"Power-On Self-Test (POST) Error Message" on page 69
Symptoms cannot be re-created (intermittent problems).	Use the customer-reported symptoms and go to "Power-On Self-Test (POST) Error Message" on page 69 "Intermittent Problems" on page 75 "Undetermined Problems" on page 76

---

## System Check Procedures

### External Diskette Drive Check

Do the following steps to isolate the problem to a controller, driver, or diskette. A write-enabled, diagnostic diskette is required.

**NOTE:** Make sure that the diskette does not have more than one label attached to it. Multiple labels can cause damage to the drive or cause the drive to fail.

Do the following to select the test device. See “System Diagnostic Diskette” on page 45 for details.

1. The FDD heads can become dirty over time, affecting their performance. Use an FDD cleaning kit to clean the heads. If the FDD still does not function properly after cleaning, go to next step.
2. Boot from diagnostic program (see “System Diagnostic Diskette” on page 45)
3. If an error occurs with the internal diskette drive, reconnect the diskette connector on the main board.

If the error still remains:

1. Reconnect the external diskette drive module.
2. Replace the external diskette drive module.
3. Replace the main board.

### External CD-ROM/DVD-ROM Drive Check

Do the following to isolate the problem to a controller, drive, or CD-ROM/DVD-ROM. Make sure that the CD-ROM does not have any label attached to it. The label can cause damage to the drive or can cause the drive to fail.

Do the following to select the test device:

1. Insert an audio CD into the CD/DVD drive. If the CD/DVD drive can read the data from the audio CD. The drive does not have problem, then go to next step. If the CD/DVD LED on the front panel does not emit light as it read the data from the audio CD, then go to next step. However, if the CD/DVD drive can not read data from the audio CD, you may need to clean the CD/DVD drive with a CD/DVD drive cleaning disk.
2. Make sure that the appropriate driver has been installed on the computer for the CD/DVD drive.
3. Boot from the diagnostics diskette and start the diagnostics program (refer to “System Diagnostic Diskette” on page 45.)
4. See if CD-ROM Test is passed when the program runs to CD-ROM/DVD-ROM Test.
5. Follow the instructions in the message window.

If an error occurs, reconnect the connector on the main board. If the error still remains:

1. Reconnect the CD-ROM/DVD-ROM module.
2. Replace the CD-ROM/DVD-ROM module.
3. Replace the main board.



---

## Keyboard or Auxiliary Input Device Check

Remove the external keyboard if the internal keyboard is to be tested.

If the internal keyboard does not work or an unexpected character appears, make sure that the flexible cable extending from the keyboard is correctly seated in the connector on the main board.

If the keyboard cable connection is correct, run the Keyboard Test. See “System Diagnostic Diskette” on page 45 for more details.

If the tests detect a keyboard problem, do the following one at a time to correct the problem. Do not replace a non-defective FRU:

1. Reconnect the keyboard cables.
2. Replace the keyboard.
3. Replace the main board.

The following auxiliary input devices are supported by this computer:

- Embedded Numeric Keypad
- External keyboard

If any of these devices do not work, reconnect the cable connector and repeat the failing operation.

## Memory Check

Memory errors might stop system operations, show error messages on the screen, or hang the system. Currently, we do not provide memory test program. However, if you need to check memory but have no testing program or diagnostic utility at hand, please go to <http://www.passmark.com> to download the shareware “BurnIn Test V.3.0”. You may test the memory with this program under Window XP environment.

**NOTE:** Make sure that the DIMM is fully installed into the connector. A loose connection can cause an error.

## Power System Check

To verify the symptom of the problem, power on the computer using each of the following power sources:

1. Remove the battery pack.
2. Connect the power adapter and check that power is supplied.
3. Disconnect the power adapter and install the charged battery pack; then check that power is supplied by the battery pack.

If you suspect a power problem, see the appropriate power supply check in the following list:

- “Check the Power Adapter” on page 66
- “Check the Battery Pack” on page 67

## Check the Power Adapter

Unplug the power adapter cable from the computer and measure the output voltage at the plug of the power adapter cable. See the following figure

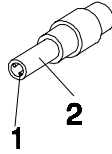

Pin 1: 19V  
Pin 2: 0V, Ground

1. If the voltage is not correct, replace the power adapter.
2. If the voltage is within the range, do the following:
  - Replace the main board.
  - If the problem is not corrected, see “Undetermined Problems” on page 76.
  - If the voltage is not correct, go to the next step.

**NOTE:** An audible noise from the power adapter does not always indicate a defect.

3. If the DC-IN indicator does not light up, check the power cord of the power adapter for correct continuity and installation.
4. If the operational charge does not work, see “Check the Power Adapter” on page 66.

## Check the Battery Pack

To check the battery pack, do the following:

From Software:

1. Check out the Power Options in control Panel
2. In Power Meter, confirm that if the parameters shown in the screen for Current Power Source and Total Battery Power Remaining are correct.
3. Repeat the steps 1 and 2, for both battery and adapter.
4. This helps you identify first the problem is on recharging or discharging.

From Hardware:

1. Power off the computer.
2. Remove the battery pack and measure the voltage between battery terminals 1(+) and 6(ground).
3. If the voltage is still less than 7.5 Vdc after recharging, replace the battery.
4. If the voltage is within the normal range, run the diagnostic program.

To check the battery charge operation, use a discharged battery pack or a battery pack that has less than 50% of the total power remaining when installed in the computer.

If the battery status indicator does not light up, remove the battery pack and let it return to room temperature. Re-install the battery pack.

If the charge indicator still does not emit, replace the battery pack. If the charge indicator still does not light up, replace the DC/DC charger board.

## Touchpad Check

If the touchpad doesn't work, do the following actions one at a time to correct the problem. Do not replace a non-defective FRU:

1. After rebooting, run Touch pad/PS2 Mode Driver.
2. Run utility with the PS/2 mouse function and check if the mouse is working.
3. If the PS/2 mouse does not work, then check if the main board to switch board FPC is connected well.
4. If the main board to switch board FPC is connected well, then check if the touch pad FPC connects to the main board properly.
5. If there is still an error after you have connected the touch pad FPC to the main board properly, then replace the touch pad or touch pad FPC. The touch pad or touch pad FPC may be damaged.
6. Replace switch board.
7. If the touch pad still does not work, then replace the FPC on Track Pad PCB.

After you use the touchpad, the pointer drifts on the screen for a short time. This self-acting pointer movement can occur when a slight, steady pressure is applied to the touchpad pointer. This symptom is not a hardware problem. No service actions are necessary if the pointer movement stops in a short period of time.

## Display Check

1. Connect an external display to the computer's external monitor port, the boot the computer. The computer can automatically detect the external display. Press Fn+ p to switch to the external display.
2. If the external display works fine, the internal LCD may be damaged. Then perform the following steps:

Make sure the DDRAM module is seated properly. Then run the display test again. If the problem still exists, go to next step.

Replace the inverter board, then run the display test program again. If the problem still occurs, go on next step.

Replace the LCD module with a new one then run the display test again. If the problem still happens, continue next step.

Replace LCD/FL cable with a new one then execute the display diagnostic again. If the problem

still occurs, continue next step.

Replace the CPU with another of the same specifications. If the problems still occurs, go to next step.

The main board may be damaged. Replace main board.

3. If the external monitor has the same problem as the internal monitor, the main board may be damaged. Please insert the diagnostic disk and run the display test program and go through the sub-steps under step 2.

## Sound Check

To determine if the computer's built-in speakers are functioning properly, perform the following steps. Before you start the steps below, adjust the speaker volume to an appropriate level.

1. Try different audio sources. For example, employ audio CD and digital music file to determine whether the fault is in the speaker system or not. If not all sources have sound problem, the problem is in the source devices. If all have the same problem, continue next step.
2. Connect a set of earphone or external speakers. If these devices work fine, go to next step. If not, then the main board may be defective or damaged. Replace the main board.
3. Follow the disassembling steps in Chapter 3. Ensure the speaker cable is firmly connected to the main board. If the speaker is still a malfunction, go on next step.
4. If the speakers do not sound properly, the speakers may be defective or damaged. Replace the speakers. If the problem still occurs, then replace the main board.

---

## Power-On Self-Test (POST) Error Message

The POST error message index lists the error message and their possible causes. The most likely cause is listed first.

**NOTE:** Perform the FRU replacement or actions in the sequence shown in FRU/Action column, if the FRU replacement does not solve the problem, put the original part back in the computer. Do not replace a non-defective FRU.

This index can also help you determine the next possible FRU to be replaced when servicing a computer.

If the symptom is not listed, see “Undetermined Problems” on page 76.

The following lists the error messages that the BIOS displays on the screen and the error symptoms classified by function.

**NOTE:** Most of the error messages occur during POST. Some of them display information about a hardware device, e.g., the amount of memory installed. Others may indicate a problem with a device, such as the way it has been configured.

**NOTE:** If the system fails after you make changes in the BIOS Setup Utility menus, reset the computer, enter Setup and install Setup defaults or correct the error.

## Index of Error Messages

### Error Message List

Error Messages	FRU/Action in Sequence
0200 Failure Fixed Disk	Hard disk error detected. Check to see if fixed disk is attached properly. Enter the BIOS Setup Utility and verify the hard disk is detected.
0211 Keyboard error	see "Keyboard or Auxiliary Input Device Check" on page 65.
0212 Keyboard Controller Failed	see "Keyboard or Auxiliary Input Device Check" on page 65. May require replacing the keyboard controller.
0213 Keyboard locked - Unlock key switch	Unlock the system to proceed.
0220 Monitor type does not match CMOS - Run SETUP	Display device mismatch. Enter the BIOS Setup Utility and verify the parameters (try loading the default settings); then save and restart the computer.
0230 System RAM Failed at offset: nnnn	Shadow RAM test failed Main board
0231 Shadow RAM Failed at offset: nnnn	System RAM test failed Main board
0232 Extended RAM Failed at address line: nnnn	Extended RAM test failed Main board
0250 System battery is dead - Replace and run SETUP	CMOS clock battery needs to be replaced. Replace the battery and run BIOS Setup Utility to reconfigure system time, then reboot system.
0251 System CMOS checksum bad - Default configuration used	CMOS has been corrupted or modified incorrectly. Run BIOS Setup Utility and verify the parameters; then save and restart the computer. Check the system battery.
0260 System timer error	System timer test failed, and the main board needs to be repaired. Run BIOS Setup Utility to reconfigure system time, then reboot system. Main board
0270 Real time clock error	RTC battery Run BIOS Setup Utility to reconfigure system time, then reboot system. Main board
0280 Previous boot incomplete - Default configuration used	Previous boot-up was not completed successfully. Enter the BIOS Setup Utility and verify the parameters (try loading the default settings); then save and restart the computer. RTC battery Main board
0281 Memory size found by POST differed from EISA CMOS	Run "Load Setup Defaults" in BIOS Setup Utility. Main board
02B0 Diskette drive A error	Drive A: or B: is present but fails the BIOS POST diskette tests. Check the drive is defined with the proper diskette type in BIOS Setup Utility Check if the diskette drive is attached correctly. See "External Diskette Drive Check" on page 64.
02B2 Incorrect Drive A type - run SETUP	Type of floppy drive A: not correctly identified in Setup. Main board
02D0 System cache error - Cache disabled	RAM cache failed and BIOS disabled the cache. On older boards, check the cache jumpers. You may have to replace the cache. Main board

**Error Message List**

<b>Error Messages</b>	<b>FRU/Action in Sequence</b>
02F0 CPU ID	CPU socket number for Multi-Processor error. Main board
02F4 EISA CMOS not writeable	System unable to write to EISA CMOS. Main board
02F5 DMA Test Failed	System unable to write to DMA (Direct Memory Access) registers. Main board
02F6 Software NMI Failed	System unable to generate software NMI (Non-Maskable Interrupt). Main board
02F7 Fail-Safe Timer NMI Failed	Fail-Safe Timer takes too long. Main board
Invalid System Configuration Data	Error with NVRAM (CMOS) data. Enter the BIOS Setup Utility and verify the parameters (try loading the default settings); then save and restart your computer. Main board
Operating system not found	Operating system cannot be found on the boot device. Enter the BIOS Setup Utility and verify the parameters (try loading the default settings); then save and restart the computer. Recover hard disk. Reinstall the operating system.
Parity Check 1 <i>nnnn</i>	Parity error found on system bus. BIOS attempts to locate the address and display it on the screen. If it cannot locate the address, it displays.
Parity Check 2 <i>nnnn</i>	Parity error found on I/O bus. BIOS attempts to locate the address and display it on the screen. If it cannot locate the address, it displays .

## Index of Symptom-to-FRU Error Message

### LCD-Related Symptoms

Symptom / Error	Action in Sequence
LCD backlight doesn't work LCD is too dark LCD brightness cannot be adjusted LCD contrast cannot be adjusted	Enter BIOS Utility to execute "Load Setup Defaults" on Exit screen, then reboot system. Reconnect the LCD connectors. Keyboard (if contrast and brightness function key doesn't work). LCD cable LCD inverter LCD Main board
Unreadable LCD screen Missing pels in characters Abnormal screen Wrong color displayed	Reconnect the LCD connector LCD cable LCD inverter LCD Main board
LCD has extra horizontal or vertical lines displayed.	LCD inverter LCD cable LCD Main board

### Indicator-Related Symptoms

Symptom / Error	Action in Sequence
Indicator incorrectly remains off or on, but system runs correctly	Reconnect the inverter board Inverter board Main board

### Power-Related Symptoms

Symptom / Error	Action in Sequence
Power shuts down during operation	Power source (battery pack and power adapter). See "Power System Check" on page 65. Battery pack Power adapter Hard drive & battery connection board Main board
The system doesn't power-on.	Power source (battery pack and power adapter). See "Power System Check" on page 65". Battery pack Power adapter Hard drive & battery connection board Main board
The system doesn't power-off.	Power source (battery pack and power adapter). See "Power System Check" on page 65. Hold and press the power switch for more than 4 seconds. Main board
Battery can't be charged	See "Check the Power Adapter" on page 66. Battery pack Main board



### PCMCIA-Related Symptoms

Symptom / Error	Action in Sequence
System cannot detect the PC Card (PCMCIA)	See "System Diagnostic Diskette" on page 45. Please run Sycard 32 Bit test. PCMCIA slot assembly Main board
PCMCIA slot pin is damaged.	PCMCIA slot assembly

### Memory-Related Symptoms

Symptom / Error	Action in Sequence
Memory count (size) appears different from actual size.	DIMM Main board

### Speaker-Related Symptoms

Symptom / Error	Action in Sequence
In Windows, multimedia programs, no sound comes from the computer.	See "Sound Check" on page 68 Audio driver Speaker Main board
Internal speakers make noise or emit no sound.	See "Sound Check" on page 68 Speaker Main board

### Power Management-Related Symptoms

Symptom / Error	Action in Sequence
The system will not enter hibernation	Keyboard (if control is from the keyboard) Hard disk drive Main board
The system doesn't enter hibernation mode and four short beeps every minute.	Press Fn+F4 and see if the computer enters hibernation mode. Touchpad Keyboard Hard disk connection board Hard disk drive Main board
The system doesn't enter standby mode after closing the LCD	LCD cover switch Main board
The system doesn't resume from hibernation mode.	Hard disk connection board Hard disk drive Main board
The system doesn't resume from standby mode after opening the LCD.	LCD cover switch Main board
Battery fuel gauge in Windows doesn't go higher than 90%.	Remove battery pack and let it cool for 2 hours. Refresh battery (continue use battery until power off, then charge battery). Battery pack Main board
System hangs intermittently.	Reconnect hard disk drives. Hard disk drive connector Main board

### Peripheral-Related Symptoms

Symptom / Error	Action in Sequence
System configuration does not match the installed devices.	Enter BIOS Setup Utility to execute "Load Setup defaults", then reboot system. Reconnect hard disk/CD-ROM/diskette drives.
External display does not work correctly.	See "System Diagnostic Diskette" on page 45 See if there is an error beep. If there is an error beep, then change main board. Power off. Then check if RAM CPU BIOS are well-connected. Press Fn+F5 three times slowly LCD FPC LCD inverter LCD
USB does not work correctly	USB device cable is firmly connected into the USB ports. Test one USB port each time. USB socket is firmly secured to the main board. Main board
Print problems.	Ensure the "Parallel Port" in the "System Devices" of BIOS Setup Utility is set to Enabled. Onboard Devices Configuration Run parallel port test Printer driver Printer cable Printer Main board

### Keyboard/Touchpad-Related Symptoms

Symptom / Error	Action in Sequence
Keyboard (one or more keys) does not work.	Reconnect the keyboard cable. Keyboard Main board
Touchpad does not work.	Reconnect touch pad cable. Modem port is secured to the main board Touch pad FPC Audio/Touch pad board Main board

### Modem-Related Symptoms

Symptom / Error	Action in Sequence
Internal modem does not work correctly.	Ensure the telephone cable is firmly plugged into the telephone wall socket and the modem port of the computer. Modem phone port is secured to the main board. modem combo board Main board

**NOTE:** If you cannot find a symptom or an error in this list and the problem remains, see "Undetermined Problems" on page 76.

---

## Intermittent Problems

Intermittent system hang problems can be caused by a variety of reasons that have nothing to do with a hardware defect, such as: cosmic radiation, electrostatic discharge, or software errors. FRU replacement should be considered only when a recurring problem exists.

When analyzing an intermittent problem, do the following:

1. Run the diagnostic test for several times to isolate the problem.
2. If no error is detected, do not replace any FRU.
3. If any error is detected, replace the FRU. Rerun the test to verify that there are no more errors.

If an error is detected by the main battery test, see “Check the Power Adapter” on page 66

If an error is detected by the display test, see “Index of Symptom-to-FRU Error Message” on page 72 .

If an error is detected by the floppy disk drive test, see “External Diskette Drive Check” on page 64.

If an error is detected by the keyboard test, see “Keyboard or Auxiliary Input Device Check” on page 65.

---

## Undetermined Problems

The diagnostic problems does not identify which adapter or device failed, which installed devices are incorrect, whether a short circuit is suspected, or whether the system is inoperative.

Follow these procedures to isolate the failing FRU (do not isolate non-defective FRU).

**NOTE:** Verify that all attached devices are supported by the computer.

**NOTE:** Verify that the power supply being used at the time of the failure is operating correctly. (See "Power System Check" on page 65):

1. Power-off the computer.
2. Visually check them for damage. If any problems are found, replace the FRU.
3. Remove or disconnect all of the following devices:
  - Non-Acer devices
  - Printer, mouse, and other external devices
  - Battery pack
  - Hard disk drive
  - DIMM
  - CD-ROM/Diskette drive Module
  - PC Cards
4. Power-on the computer.
5. Determine if the problem has changed.
6. If the problem does not recur, reconnect the removed devices one at a time until you find the failing FRU.
7. If the problem remains, replace the following FRU one at a time. Do not replace a non-defective FRU:
  - Main board
  - LCD assembly

---

## Index of AFlash BIOS Error Message

Error Message	Action in Sequence
Hardware Error	See "System Diagnostic Diskette" on page 45
VPD Checksum Error	Reboot the system and then retest with this diskette.
BIOS Update Program Error	Turn off the power and restart the system.
System Error	Make sure this AFlash BIOS diskette for this model.
Without AC adapter	make sure to connect AC adapter
Battery Low	make sure to install a highly charged battery, and reboot system.



## FRU (Field Replaceable Unit) List

---

This chapter gives you the FRU (Field Replaceable Unit) listing in global configurations of TravelMate 800 series products. Refer to this chapter whenever ordering for parts to repair or for RMA (Return Merchandise Authorization).

Please note that WHEN ORDERING FRU PARTS, you should check the most up-to-date information available on your regional web or channel. For whatever reasons a part number change is made, it will not be noted on the printed Service Guide. For ACER AUTHORIZED SERVICE PROVIDERS, your Acer office may have a DIFFERENT part number code from those given in the FRU list of this printed Service Guide. You MUST use the local FRU list provided by your regional Acer office to order FRU parts for repair and service of customer machines.

**NOTE:** To scrap or to return the defective parts, you should follow the local government ordinance or regulations on how to dispose it properly, or follow the rules set by your regional Acer office on how to return it.

# Exploded Diagram THE SYSTEM

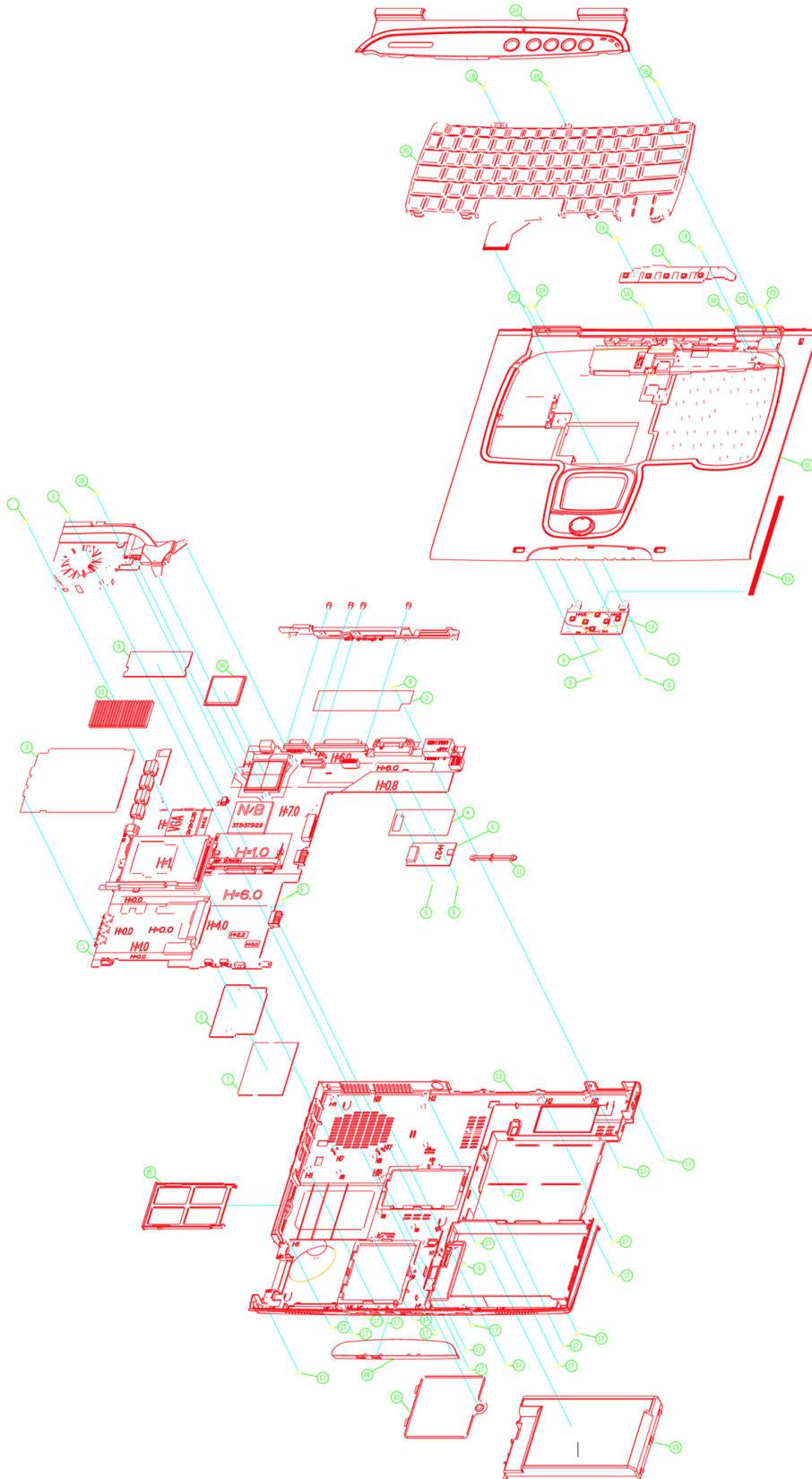



# LCD

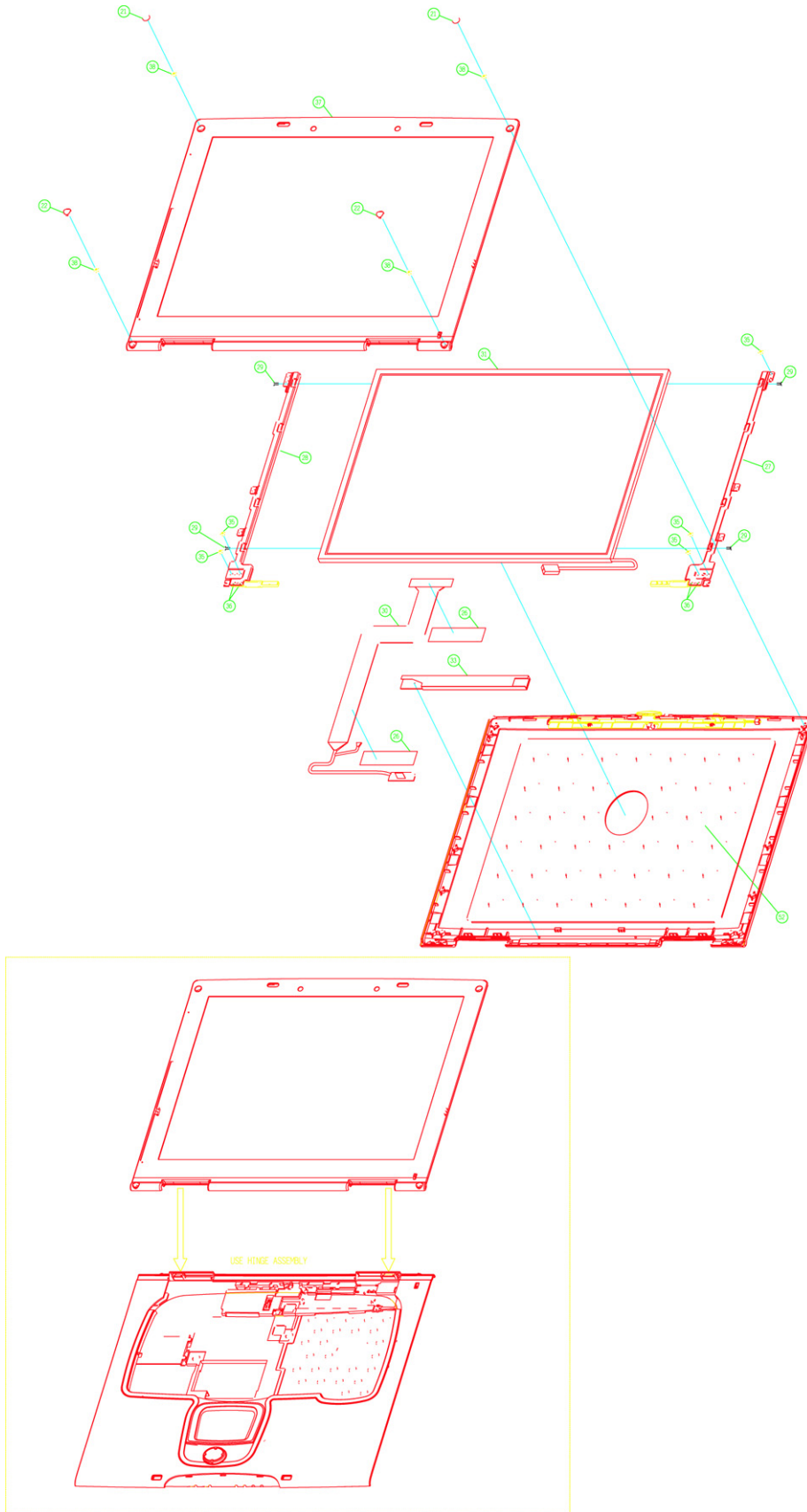



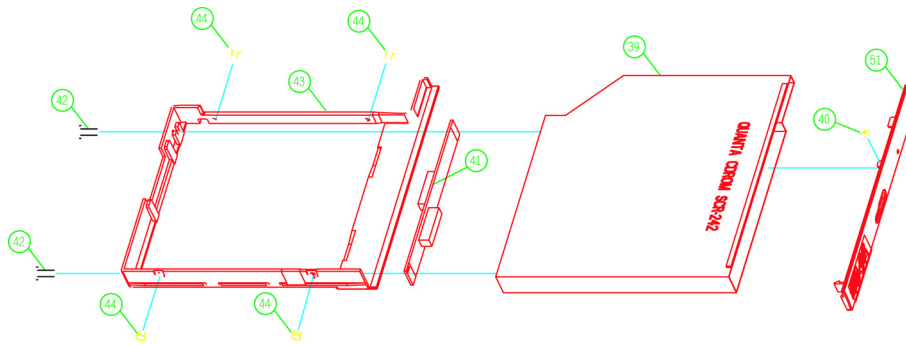

## DVD ASSY



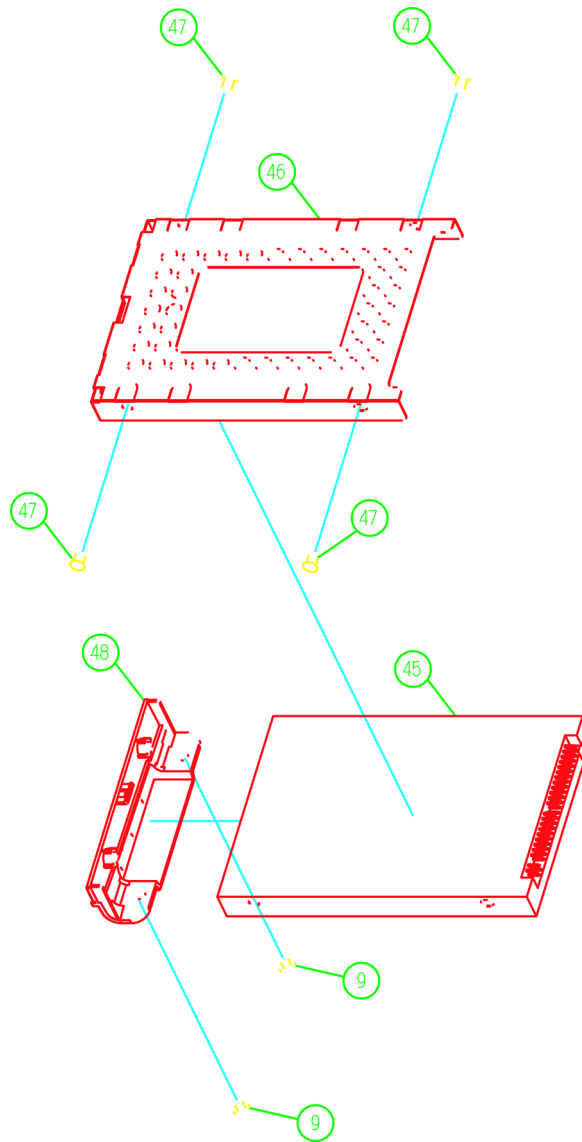



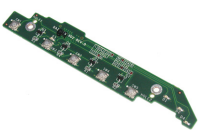

**NOTE:** The exploded diagrams for CD-ROM, DVD-ROM and DVD-RW combo module are very similar. Therefore, we put only DVD ASSY exploded diagram for your reference. Please also refer to the FRU list below for more information on different models and part numbers. This diagram only explains the relevant location of each part. The parts on the exploded diagrams may be a slightly different from its actual looks.

# HDD (W/O HDD) ASSY

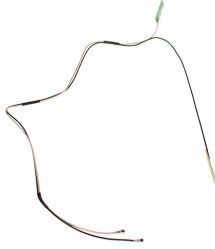

CATEGORY	PARTNAME	PART NO.
<b>ADAPTER</b>		
	ADPATER DALTA 75W Delta ADP-75FBA PFC	AP.T2301.001
	ADPATER LITEON 75W Lite-On PA-1750-02CA PFC	AP.T2303.001
<b>BATTERY</b>		
	BATTERY SANYO LI-ION 8CELL 4400mAH SI-QT83	BT.T2303.001
	BATTERY SIMPLO LI-ION 8CELL (BATTERY PACK ZG14S2P, 4400mAH)	BT.T2306.001
	BATTERY SANYO LI-ION 6CELL (MODEL NAME:3UF103450P-2-QC-20,3600 Mah)	BT.T2303.002
<b>BOARD</b>		
	MODEM BOARD AMBIT U98M005.05	54.T23V7.001
	MODEM /BLUETOOTH COMBO BOARD AMBIT T60M665.00	54.T23V7.002
	WIRELESS LAN BOARD (802.11b) INTEL WM3B2100	54.T25V7.001
	WIRELESS LAN BOARD (802.11a+b) INTEL WM3B7100	54.T25V7.002
	WIRELESS LAN BOARD (802.11a+b) AMBIT T60H677.01	54.T23V7.004
	LAUNCH BOARD	55.T25V7.001
	TOUCH PAD BOARD	55.T25V7.002





CATEGORY	PARTNAME	PART NO.
<b>CABLES</b>		
	FFC - TOUCHPAD (M/B-- T/P BOARD-- LONG)	50.T25V7.001
	FFC - TOUCHPAD (T/P BOARD-- T/P---SHORT)	50.T25V7.002
	MODEM CABLE	50.T23V7.002
	POWER CORD US (3 pin)	27.T23V7.001
	POWER CORD PRC ( 3 Pin)	27.T23V7.003
	POWER CORD KOERA ( Pin)	27.T23V7.006
	POWER CORD Continetal ( 3 pin )	27.T25V7.002
	POWER CORD DANISH ( 3 pin )	27.T25V7.003
	POWER CORD ITALIAN ( 3pin )	27.T25V7.004
	POWER CORD SWISS ( 3pin )	27.T25V7.006
	POWER CORD UK ( 3pin )	27.T25V7.007
<b>COMMUNICATION MODULE</b>		
	WIRELESS LAN ANTENNA SET	50.T25V7.004
	BLUETOOTH ANTENNA CABLE	50.T25V7.005





CATEGORY	PARTNAME	PART NO.
CASE/COVER/BRACKET ASSEMBLY		
	MIDDLE COVER W/ NAME PLATE	42.T24V5.001
	DIMM DOOR W/CAPTURED SCREW	42.T25V7.002
	MINI PCI DOOR W/CAPTURED SCREW	42.T25V7.003
FRONT BEZEL		
	UPPER CASE ASSY W/ TOUCHPAD	60.T25V7.001
	LOWER CASE ASSY W/O SPEAKER	60.T25V7.002
	IO SHIELDING	33.T25V7.001
CPU		

CATEGORY	PARTNAME	PART NO.
	INTEL BANIAS 1.3GHz 1M 1.35V UFCPGA2	KC.BS001.13G
	INTEL BANIAS 1.4GHz 1M 1.48V UFCPGA2	KC.BS001.14G
	INTEL BANIAS 1.5GHz 1M 1.48V UFCPGA2	KC.BS001.15G
	INTEL BANIAS 1.6GHz 1M 1.48V UFCPGA2	KC.BS001.16G
DVD-ROM DRIVE		
	DVD-ROM MODULE 8X QSI SDR-083	6M.T23V7.004
	DVD-ROM DRIVE 8X QSI SDR-083	KV.08X03.001
	DVD-ROM BEZEL FOR QSI	42.T23V7.007
CASE/COVER/BACKET ASSEMBLY		
	OPTICAL DEVICE HOLDER	33.T23V7.003
BOARD		
	OPTICAL DEVICE BOARD	55.T23V7.003
DVD-ROM DRIVE	DVD-ROM MODULE 8X MKE SR-8178	6M.T23V7.003
DVD-ROM DRIVE	DVD-ROM DRIVE 8X MKE SR-8178	KV.08X02.002
DVD-ROM DRIVE	DVD-ROM BEZEL FOR MKE	42.T23V7.006
CASE/COVER/ BRACKET ASSEMBLY	OPTICAL DEVICE HOLDER	33.T23V7.003
BOARD	OPTICAL DEVICE BOARD	55.T23V7.003

CATEGORY	PARTNAME	PART NO.
DVD-RW COMBO DRIVE	DVD-RW COMBO MODULE 24X QSI SBW-242	
DVD-RW COMBO DRIVE	DVD/CDRW COMBO DRIVE 24X QSI SBW-242	KO.24X07.002
DVD-RW COMBO DRIVE	DVD-RW COMBO BEZEL FOR QSI	42.T23V7.008
CASE/COVER/ BRACKET ASSEMBLY	OPTICAL DEVICE HOLDER	33.T23V7.003
BOARD	OPTICAL DEVICE BOARD	55.T23V7.003
DVD-RW COMBO DRIVE	DVD-RW COMBO MODULE 24X KME UJDA740	6M.T23V7.006
DVD-RW COMBO DRIVE	DVD/CDRW KME UJDA740 24x10x24x8x	KO.24X03.001
DVD-RW COMBO DRIVE	DVD-RW COMBO BEZEL FOR MKE	42.T23V7.009
CASE/COVER/ BRACKET ASSEMBLY	OPTICAL DEVICE HOLDER	33.T23V7.003
BOARD	OPTICAL DEVICE BOARD	55.T23V7.003
<b>HDD/HARD DISK DRIVE</b>		
	HDD 2.5" 30G TOSHIBA NEPTUNE MK3021GAS 4200RPM	KH.33004.001
	HDD 30GB/2.5 IN./4200RPM/HITACHI EUCALYPTUS DK23EA/30	KH.33005.002
	HDD 2.5" 30G FUJITSU MHS2030AT 4200RPM	KH.03006.001
	HDD 2.5" 40G TOSHIBA NEPTUNE MK4021GAS 4200RPM	KH.34004.001
	HDD 2.5" 40G HITACHI EUCALYPTUS DK23EA/-40 4200RPM	KH.34005.002
	HDD 2.5" 40G FUJITSU MHS2040AT 4200RPM	KH.04006.001
	HDD 2.5" 60G TOSHIBA NEPTUNE MK6021GAS 4200RPM	KH.36004.001
	HDD 2.5" 60G HITACHI EUCALYPTUS DK23EA/-60 4200RPM	KH.06005.001
	HDD 2.5" 60G FUJITSU MHS2060AT 4200RPM	KH.06006.001
	HDD 2.5" 60G TOSHIBA NEPTUNE MK6022GAS 5400RPM	KH.06004.001
<b>CASE/COVER/BRACKET ASSEMBLY</b>		
	HDD COVER	42.T23V7.010
	HDD CASE	33.T23V7.004







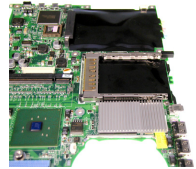

CATEGORY	PARTNAME	PART NO.
<b>KEYBOARD</b>		
	KEYBOARD DARFON US International NSK-A641D 84KEYS	KB.T2507.001
	KEYBOARD DARFON UK NSK-A640U 85KEYS	KB.T2507.002
	KEYBOARD DARFON German NSK-A640G 85KEYS	KB.T2507.003
	KEYBOARD DARFON Italian NSK-A640E 85KEYS	KB.T2507.004
	KEYBOARD DARFON Chinese NSK-A6402 84KEYS	KB.T2507.005
	KEYBOARD DARFON French NSK-A640F 85KEYS	KB.T2507.006
	KEYBOARD DARFON Swiss/G NSK-A6400 85KEYS	KB.T2507.007
	KEYBOARD DARFON Spanish NSK-A640S 85KEYS	KB.T2507.008
	KEYBOARD DARFON Portuguese NSK-06 85KEYS	KB.T2507.009
	KEYBOARD DARFON Arabic NSK-A640A 84KEYS	KB.T2507.010
	KEYBOARD DARFON Thai NSK-A6403 84KEYS	KB.T2507.011
	KEYBOARD DARFON Belgium NSK-A641A 85KEYS	KB.T2507.012
	KEYBOARD DARFON Sweden NSK-A640W 85KEYS	KB.T2507.013
	KEYBOARD DARFON Czech NSK-A640C 85KEYS	KB.T2507.014
	KEYBOARD DARFON Hungaian NSK-A640Q 85KEYS	KB.T2507.015
	KEYBOARD DARFON Norway NSK-A640N 85KEYS	KB.T2507.016
	KEYBOARD DARFON Danish NSK-A640D 85KEYS	KB.T2507.017
	KEYBOARD DARFON Turkish NSK-A640T 85KEYS	KB.T2507.018
	KEYBOARD DARFON Brazilian Portuguese NSK-A641B	KB.T2507.019
	KEYBOARD DARFON Canadian French NSK-A640M 85KEYS	KB.T2507.020
	KEYBOARD DARFON Japanese NSK-A640J 86KEYS	KB.T2507.021
	KEYBOARD DARFON Korean NSK-A640K 84KEYS	KB.T2507.022
	KEYBOARD DARFON Greek NSK-A640L 85KEYS	KB.T2507.023
	KEYBOARD DARFON Russian NSK-A640R 84KEYS	KB.T2507.024
<b>LCD</b>		
	LCD MODULE 14.1" TFT XGA IDT IAXG15	6M.T25V7.011
	LCD 14" TFT XGA IDT IAXG15 (SPWG-B)	LK.1410B.001
<b>CABLE</b>		
	LCD COAXIAL CABLE 14.1" FOR IDT	50.T25V7.011

CATEGORY	PARTNAME	PART NO.
BOARD		
	INVERTER BOARD W/MAYLAR E AMBIT T18I064.00	19.T23V7.001
	LCD INVERTER W/MAYLAR (SUMIDA- IV12129/T)	19.T23V7.002
CASE/COVER/BRACKET ASSEMBLY		
	LCD BRACKET 14.1" RIGHT W/HINGE	33.T25V7.004
	LCD BRACKET 14.1" LEFT W/HINGE	33.T25V7.005
MISCELLANEOUS	LCD LATCH KIT W/SPRING	6K.T25V7.001
	LCD PANEL WITH LOGO 14"	60.T25V7.003
	LCD BEZEL 14"	60.T25V7.004
LCD	LCD MODULE 14.1" TFT XGA QDI QD14.11XLH12	6M.T25V7.012
LCD	LCD 14" TFT XGA QDI QD14.11XLH12	LK.14109.003
CABLE	LCD COAXIAL CABLE 14.1" FOR QDI	50.T25V7.012
BOARD	INVERTER BOARD W/MAYLAR E AMBIT T18I064.00	19.T23V7.001
BOARD	LCD INVERTER W/MAYLAR (SUMIDA- IV12129/T)	19.T23V7.002
CASE/COVER/ BRACKET ASSEMBLY	LCD BRACKET 14.1" RIGHT W/HINGE	33.T25V7.004
CASE/COVER/ BRACKET ASSEMBLY	LCD BRACKET 14.1" LEFT W/HINGE	33.T25V7.005
MISCELLANEOUS	LCD LATCH KIT W/SPRING	6K.T25V7.001
CASE/COVER/ BRACKET ASSEMBLY	LCD PANEL WITH LOGO 14"	"60.T25V7.003
CASE/COVER/ BRACKET ASSEMBLY	LCD BEZEL 14"	"60.T25V7.004

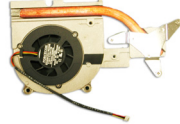
CATEGORY	PARTNAME	PART NO.
LCD	LCD MODULE 15" TFT XGA AU B150XG01 V2	6M.T25V7.014
LCD	LCD 15" TFT XGA AU B150XG01 V2 (spwg-B)	LK.15005.001
CABLE	LCD COAXIAL CABLE 15" FOR AU XGA	50.T25V7.014
BOARD	INVERTER BOARD W/MAYLAR E AMBIT T18I064	19.T23V7.001
BOARD	LCD INVERTER W/MAYLAR (SUMIDA- IV12129/T)	19.T23V7.002
CASE/COVER/ BRACKET ASSEMBLY	LCD BRACKET 15" RIGHT W/HINGE	33.T25V7.006
CASE/COVER/ BRACKET ASSEMBLY	LCD BRACKET 15" LEFT W/HINGE	33.T25V7.007
MISCELLANEOUS	LCD LATCH KIT W/SPRING	6K.T25V7.001
CASE/COVER/ BRACKET ASSEMBLY	LCD PANEL WITH LOGO 15"	"60.T25V7.005
CASE/COVER/ BRACKET ASSEMBLY	LCD BEZEL 15"	"60.T25V7.006
LCD	LCD MODULE 15" TFT XGA HITACHI TX38D81VC1CAB	6M.T25V7.015
LCD	LCD 15" TFT XGA HITACHI TX38D81VC1CAB	LK.15004.004
CABLE	LCD COAXIAL CABLE 15" FOR HITACHI XGA	50.T25V7.015
BOARD	INVERTER BOARD W/MAYLAR E AMBIT T18I064	19.T23V7.001
BOARD	LCD INVERTER W/MAYLAR (SUMIDA- IV12129/T)	19.T23V7.002
CASE/COVER/ BRACKET ASSEMBLY	LCD BRACKET 15" RIGHT W/HINGE	33.T25V7.006
CASE/COVER/ BRACKET ASSEMBLY	LCD BRACKET 15" LEFT W/HINGE	33.T25V7.007
MISCELLANEOUS	LCD LATCH KIT W/SPRING	6K.T25V7.001
CASE/COVER/ BRACKET ASSEMBLY	LCD PANEL WITH LOGO 15"	"60.T25V7.005
CASE/COVER/ BRACKET ASSEMBLY	LCD BEZEL 15"	"60.T25V7.006
LCD	LCD MODULE 15" TFT XGA LG LG150X05-A2C1	6M.T25V7.016
LCD	LCD 15" TFT XGA LG LG150X05-A2C1	LK.15008.003
CABLE	LCD COAXIAL CABLE 15" FOR LG XGA	50.T25V7.016
BOARD	INVERTER BOARD W/MAYLAR E AMBIT T18I064	19.T23V7.001
BOARD	LCD INVERTER W/MAYLAR (SUMIDA- IV12129/T)	19.T23V7.002
CASE/COVER/ BRACKET ASSEMBLY	LCD BRACKET 15" RIGHT W/HINGE	33.T25V7.006
CASE/COVER/ BRACKET ASSEMBLY	LCD BRACKET 15" LEFT W/HINGE	33.T25V7.007
MISCELLANEOUS	LCD LATCH KIT W/SPRING	6K.T25V7.001
CASE/COVER/ BRACKET ASSEMBLY	LCD PANEL WITH LOGO 15"	"60.T25V7.005
CASE/COVER/ BRACKET ASSEMBLY	LCD BEZEL 15"	"60.T25V7.006
LCD	LCD MODULE 15" TFT SXGA+ AU B150PG01	6M.T25V7.017
LCD	LCD 15" TFT SXGA+ AU B150PG01 (spwg-B)	LK.15005.002
CABLE	LCD COAXIAL CABLE 15" FOR AU SXGA+	50.T25V7.017
BOARD	INVERTER BOARD W/MAYLAR E AMBIT T18I064	19.T23V7.001

CATEGORY	PARTNAME	PART NO.
BOARD	LCD INVERTER W/MAYLAR (SUMIDA- IV12129/T)	19.T23V7.002
CASE/COVER/ BRACKET ASSEMBLY	LCD BRACKET 15" RIGHT W/HINGE	33.T25V7.006
CASE/COVER/ BRACKET ASSEMBLY	LCD BRACKET 15" LEFT W/HINGE	33.T25V7.007
MISCELLANEOUS	LCD LATCH KIT W/SPRING	6K.T25V7.001
CASE/COVER/ BRACKET ASSEMBLY	LCD PANEL WITH LOGO 15"	"60.T25V7.005
CASE/COVER/ BRACKET ASSEMBLY	LCD BEZEL 15"	"60.T25V7.006
LCD	LCD MODULE 15" TFT SXGA HITACHI TX38D91VC1FAB	6M.T25V7.018
LCD	LCD 15" TFT SXGA+ Hitachi TX38D91VC1FAB (spwg-B)	LK.15004.005
CABLE	LCD COAXIAL CABLE 15" FOR HITACHI SXGA+	50.T25V7.018
BOARD	INVERTER BOARD W/MAYLAR E AMBIT T18I064	19.T23V7.001
BOARD	LCD INVERTER W/MAYLAR (SUMIDA- IV12129/T)	19.T23V7.002
CASE/COVER/ BRACKET ASSEMBLY	LCD BRACKET 15" RIGHT W/HINGE	33.T25V7.006
CASE/COVER/ BRACKET ASSEMBLY	LCD BRACKET 15" LEFT W/HINGE	33.T25V7.007
MISCELLANEOUS	LCD LATCH KIT W/SPRING	6K.T25V7.001
CASE/COVER/ BRACKET ASSEMBLY	LCD PANEL WITH LOGO 15"	"60.T25V7.005
CASE/COVER/ BRACKET ASSEMBLY	LCD BEZEL 15"	"60.T25V7.006
LCD	LCD MODULE 15" TFT SXGA+ LG LG150E02-A2P1	6M.T25V7.019
LCD	LCD 15" TFT SXGA+ LG LG150E02-A2P1	LK.15008.004
CABLE	LCD COAXIAL CABLE 15" FOR LG SXGA+	50.T25V7.019
BOARDS	INVERTER BOARD W/MAYLAR E AMBIT T18I064	19.T23V7.001
BOARD	LCD INVERTER W/MAYLAR (SUMIDA- IV12129/T)	19.T23V7.002
CASE/COVER/ BRACKET ASSEMBLY	LCD BRACKET 15" RIGHT W/HINGE	33.T25V7.006
CASE/COVER/ BRACKET ASSEMBLY	LCD BRACKET 15" LEFT W/HINGE	33.T25V7.007
MISCELLANEOUS	LCD LATCH KIT W/SPRING	6K.T25V7.001
CASE/COVER/ BRACKET ASSEMBLY	LCD PANEL WITH LOGO 15"	"60.T25V7.005
CASE/COVER/ BRACKET ASSEMBLY	LCD BEZEL 15"	"60.T25V7.006
<b>MAINBOARD</b>		
	M/B W/SMART CARD( PCMC1 SLOT) W/O CPU, MEMORY	MB.T2506.001
<b>CASE/COVER/BRACKET ASSEMBLY</b>		

CATEGORY	PARTNAME	PART NO.
	PCMCIA SLOT	21.T25V7.001
Memory		
	MEMORY SO-DIMM DDR266/256MB/0.14U /INFINEON HYS64D32020 GDL-7-B	KN.25602.001
	256MB MICRON MT8VDDT3264HDG-265C3(16MX16)	KN.25604.004
	256MB ELPIDA W30256A6EPI652A	KN.25609.001
	512MB MICRON MT16VDDS6464HG-265B4	KN.51204.002
	512MB INFINEON HYS64D64020GBDL-7-B 64MX64 (.14U)	KN.51202.003
	FAN	31.T25V7.001
HEATSINK		
	VGA SINK W/MYLAR	23.T25V7.001
READER		
	SMART CARD READER	60.T23V7.007
SPAEKER		
	SPEAKER ASSY (L&R)	23.T25V7.002
MISCELLANEOUS	LCD SCREW CUSION RUBBER	47.T25V7.001
MISCELLANEOUS	LCD SCREW FLAT RUBBER	47.T25V7.001
SCREWS	SCREW I3*3.5M-NIH(M3L3.5)	86.T25V7.002
SCREWS	SCREW NUT IO	86.T23V7.001
SCREWS	SCREW CPU NUT ZG1S(MBZG1001,REV3A)	86.T25V7.004

CATEGORY	PARTNAME	PART NO.
SCREWS	SCREW M2.0X2.5-I-NI-NYLOK	86.T23V7.003
SCREWS	SCREW I2*3M-NIH(Y (M2L3)	86.T25V7.008
SCREWS	SCREW M2.5X5.0-I-NI-NYLOK	86.T23V7.010
SCREWS	SCREW I2.5*2.5M-BNIH(4.5,0.8)	
SCREWS	SCREW M2.5X3-I-NI-NYLOK	86.T23V7.007
SCREWS	SCREW I2.5*3M-BNIH(M2.5L3)	86.T25V7.012
SCREWS	SCREW I2.5*4M-BKAGHY(M2.5L4)	86.T25V7.013
SCREWS	SCREW M2.5*5-I(BNI)(NYLOK)	86.T25V7.014
SCREWS	SCREW I2.5*6M-BNIHY(M2.5L6 I)	86.T25V7.015
SCREWS	SCREW M2.5*7-I(NI,NYLOK)	86.T25V7.016
SCREWS	SCREW M1.7X3.5-I-BZN	86.T23V7.013
SCREWS	SCREW M2X3-I-BNI-NYLOK	86.T23V7.014
SCREWS	SCREW BI2*5TA-BNIH(4,0.6)	86.T25V7.019
SCREWS	SCREW I2*6M-NIH(Y(3.5,0.4)	86.T25V7.020



## Model Definition and Configuration

### TravelMate 800 Series

Model	Country	CPU	LCD	Memory	HDD (GB)	ODD	Card Reader	Wireless LAN	Bluetooth
800LCi		PM 1.3G	15.0 SXGA+	2x256M	40G	24x CDRW +DVD	N	11b	N
800LCi	USA & Canada	PM 1.3G	15.0 SXGA+	1x256M	40G	24x CDRW +DVD	Y	11a/b; 11b	N
800XC		PM 1.3G	14.1 XGA	1x256M	30G	24x CDRW +DVD	Y	N	N
800XC i		PM 1.3G	14.1 XGA	1x256M	40G	24x CDRW +DVD	Y	11b	N
802LCi	AFE / AMS / TWN	PM 1.5G	15.0 SXGA+	1x256M	60G	24x CDRW +DVD	Y	11b	N
802LCi	USA & Canada / ACLA	PM 1.5G	15.0 SXGA+	1x512M	60G (5400 rpm)	24x CDRW +DVD	Y	11a/b	Y
803LCi		PM 1.6G	15.0 SXGA+	2x256M	40G	24x CDRW +DVD	N	11b	N
803LCi	AFE / AMS / TWN	PM 1.6G	15.0 SXGA+	1x256M	60G	24x CDRW +DVD	Y	11b	N
803LCi	USA & Canada / ACLA	PM 1.6G	15.0 SXGA+	1x512M	60G (5400 rpm)	24x CDRW +DVD	Y	11a/b	Y
803LCi	AAP / Thailand	PM 1.6G	15.0 SXGA+	1x512M	60G (5400 rpm)	24x CDRW +DVD	Y	11b	N



---

## Main Features

- Intel® Pentium® M Processor 1.3 GHz ~ 1.6GHz or higher; featuring Intel® Enhanced SpeedStep™ technology
- Intel 885PM (ODEM) + ICH4 chipset
- 256MB DDR266 SDRAM, upgradeable to 2GB on dual soDIMM sockets
- 14.1" XGA TFT LCD with 1024 X 768 pixel, 16.7 million colors; 15.0" SXGA+ TFT LCD with 1400 X 1050 pixel, 16.7 million colors; 15.0" UGA TFT LCD with 1600 X 1200 pixel, 16.7 million colors
- 30GB or higher capacity Enhanced-IDE hard disk
- Acer Media Bay hot-swappable 8X DVD ROM or 24X DVD/CD-RW combo or DVD-RW drive module
- Embedded 10/100 Mbps Fast Ethernet; Integrated Intel® Pro/Wireless 2100 or Intel® Pro/wireless 2100A network connection; Integrated Bluetooth™
- 56K ITU V.92 data/fax software modem (Wake-on-Ring ready)
- ACP 1.0b Power Management; 65Wh li-oh battery pack; 5.5-hour battery life; 1.5-hour rapid-charge; 3.5-hour charge-in-use
- FineTouch keyboard with 5o curve; built-in touchpad with ergonomic buttons and 4-way integrated scroll keys; hotkey controls; 4 launch keys and 2 programmable keys
- Microsoft Windows XP operating system / Windows 2000 operating system



## Test Compatible Components

---

This computer's compatibility is tested and verified by Acer's internal testing department. All of its system functions are tested under Windows® XP and Windows® 2000 environment.

Refer to the following lists for components, adapter cards, and peripherals which have passed these tests. Regarding configuration, combination and test procedures, please refer to the TravelMate 800 series Compatibility Test Report released by the Acer Mobile System Testing Department.

## Microsoft® Windows® XP Environment Test

Item	Specifications
MONITORS	Philips 109P 10
	Dell Trinitron 21"
	ViewSonic GS773
	ViewSonic GS790
	ViewSonic PF775
PARALLEL PORT	Printer:
	HP Laser Jet 5M
	HP Desk Jet 930C
	HP Desk Jet 840C
	IOMega ZIP (LPT Port)
	Cable:
	LL5 cable
1394 PORT	1394 WD 30GB HDD
	1394 HDD /IEEE 1394 (Fire Wire)/USB 1.1 Combo Hard Drive\FUJITSU MHS2030AT
	1394 Wise HDD (WA11004)
	1394 CCD(Stealth Fire)
	1394 HUB: Aten 1394 HUB /FH-600
	1394 SONY DV /DCR-PC100
Projector	Panasonic PT-L556EA
	ACER 7755C
USB 2.0	USB HUB: 4 Port \Highlight
	USB HDD: Easy BOX /Ennyah
	HDD:logear HI-SPEE HDD USB 2.0 EXTERNAL
	USB DVD/CD-RW (Pioneer DVR-104)
	Adaptec USB 2.0 PCMCIA card
GB LAN Hub	3 COM GB LAN Hub
PS/2 Port	Keyboard:
	Microsoft Natural K/B
	Acer JVPKBS-WIN K/B
	KeyPad:
	PC concepts keypad KB-5640
	Mouse:
	Microsoft IntelliMouse Explorer
	Microsoft PS/2 Mouse
COMPAQ Mouse	
COM Port	Microsoft Serial Mouse 2.0 \C3KKS2
PC CARDS	Modem Card:
	Xircom CreditCard Modem 56 (CME56-100)
	Xircom CreditCard Modem 56 (CM-56G)
	3Com 56K Modem (3CCM156)
	3Com 56K Modem (3CXM756)
	GVC 56K Modem (VF-1156PV/C3)
	LAN Card:

Item	Specifications
	D-Link Fast Ethernet DFE-650
	D-Link CardBus DE-660
	3COM 10/100 16Bit LAN Card (3CCFE574BT)
	3COM(DELL) 10/100 BAST-TX LAN Card (3CCFE575BT-D)
	3COM 10/100 CardBus LAN Card (3CCFE575CT)
	3COM 10M LAN Card (3CCE589ET)
	Xircom CreditCard Ethernet 10/100 (CE3B-100)
	Xircom CardBus Ethernet II 10/100 (CBE2-100)/32bit
	Pci_ Fast Ethernet Card FNW-3602-TX
	SCSI
	Adaptec SlimSCSI APA-1450A Card
	Adaptec SlimSCSI APA-1460D Card
	Adaptec SlimSCSI 1480A CardBus UltraSCSI Card
	LAN + Modem Card:
	3COM 10/100 LAN+56k Modem Card (3CXFEM656C)
	Xircom CreditCard Ethernet + Modem 56k (CEM56-100)
	ATA Card:
	KingMax 40MB
	Compact Flash 96MB
	IBM Microdrives 340MB
	PCMCIA IDE/ATAPI Controller
	FLASH/32MB
	IOMEGA Click! PC CARD DRIVE
	Passport CardBus + HDD
	Travel HDD 3.2GB + Passport CardBus /ACCURITE
	IEEE 1394 CardBus Card
	Compag 1394 CardBus Card
	Billionton 1394 CardBus Card
	VST Fire Wire 1394 CardBus Card
	Wireless LAN Card:
	Gemtek Wireless LAN Card
	COMPAQ Wireless LAN Card
	Bluetooth Card:
	3Com Bluetooth Card(3CRWB6096)
	MMC Card
	Apacer 64MB
	MS Card
	Sony 64MB
	Apacer 128MB
	SD Card
	Apacer 128MB
	SM Card
	Apacer 64MB
	SunDisk 128MB
	CF Card

Item	Specifications
	Canon FC-16M
	Apacer 128MB
	Pantex 128MB
	SunDisk 10MB
USB PORT	USB Mouse:
	Microsoft Optical USB Mouse
	TARGUS Wheel Mouse
	Logitech Wheel Mouse
	Acer USB Mouse M012B0
	USB Keyboard:
	Microsoft Internet Keyboard Pro
	Gateway Keyboard SK-9910U
	Gateway Keyboard SK-9926
	SILITEK K/B
	USB Camera:
	Dlink DSC 350
	Dlink DSB-C300
	Intel YC72
	USB HDD:
	Argosy HDD
	Ennyah
	IEEE 1394 (Fire Wire)/USB 1.1 Combo Hard Drive\FUJITSU MHS2030AT
	USB CD-ROM:
	IOMega ZIP CD650
	USB CDR/W :
	YAMAHA CRW-70
	PHILIPS JR24CDRW/17
	USB Printer:
	HP DeskJet 930C
	HP DeskJet 840C
	USB FDD:
	MIC USB FDD YD-8U10
	Logitech USB FDD
	Teac USB FDD
	Y-E Data USB FDD
	Sharp USB FDD
	USB LAN:
	NEC C&C-15R1
	Billionton USB-10/100 FastEthernet USB-100B
	LINKSYS USB LAN
	USB Zip:
	Iomega USB ZIP 250
	USB Scanner:
	HP ScanJet 5300C
	HP ScanJet 4100C

Item	Specifications
	USB HUB:
	PCI USB HUB
	XeXtreme USB HUB
	General purpose USB Hub /UH-9124
	USB Gamepad:
	Microsoft Sidewinder Gamepad
	Logitech WingMan GAMEPAD EXTREME
	Logitech WingMan RUMBLEPAD
	USB CCD:
	Intel USB CCD /CS430
	Dlink DSC 350 USB CCD
	Logitech QuickCam Home PC Video Camera
	USB Speaker
	Phillip DSS330
	USB Modem:
	V.90 56Kbps Fax/Modem / JATON
	USB Card Reader:
	DATAFAB 5 in 1
	USB Flash Memory:
	Apacer 128MB
AUDIO JACKS	JS-100 Jazz 3D Speaker
	J-S 3D Speaker /J-2201W
	J-S 3D Speaker /J-2202
	SANYO 3D Speaker
	SONY Earphone MDR-CD60
	Panasonic Earphone RP-H1254
	Philips Earphone
MIC.	Condenser MIC. EM-420T
	Dynamic MIC.
Game	Harry Potter
	Star Wars Rogue Squadron
	Diablo II
	Quake III
	World of Warcraft II
Access Point	Intel Access Point
S/W	Microsoft Office 2K
	Microsoft Office XP
	Lotus Notes 4.6
	WinFax10.0
	Adobe Acrobat 5.0
	Microsoft FrontPage2002
Bluetooth	Bluetooth PDA: Fujitsu SIMEMS PAD Pocket L00X
	Buletooth mobile phone: Sony Ericsson
Port Replicato	Acer Port Replicator

## Microsoft® Windows® 2000 Environment Test

Item	Specifications
MONITORS	Philips 109P 10
	Dell Trinitron 21"
	ViewSonic GS773
	ViewSonic GS790
	ViewSonic PF775
PARALLEL PORT	Printer:
	HP Laser Jet 5M
	HP Desk Jet 930C
	HP Desk Jet 840C
	IOMega ZIP (LPT Port)
	Cable:
	LL5 cable
1394 PORT	1394 WD 30GB HDD
	1394 HDD /IEEE 1394 (Fire Wire)/USB 1.1 Combo Hard Drive/FUJITSU MHS2030AT
	1394 Wise HDD (WA11004)
	1394 CCD(Stealth Fire)
	1394 HUB: Aten 1394 HUB /FH-600
	1394 SONY DV /DCR-PC100
Projector	Panasonic PT-L556EA
	ACER 7755C
USB 2.0	USB HUB: 4 Port \Highlight
	USB HDD: Easy BOX /Ennyah
	HDD:logear HI-SPEE HDD USB 2.0 EXTERNAL
	USB DVD/CD-RW (Pioneer DVR-104)
	Adaptec USB 2.0 PCMCIA card
GB LAN Hub	3 COM GB LAN Hub
PS/2 Port	Keyboard:
	Microsoft Natural K/B
	Acer JVPKBS-WIN K/B
	KeyPad:
	PC concepts keypad KB-5640
	Mouse:
	Microsoft IntelliMouse Explorer
	Microsoft PS/2 Mouse
COMPAQ Mouse	
COM Port	Microsoft Serial Mouse 2.0 \C3KKS2
PC CARDS	Modem Card:
	Xircom CreditCard Modem 56 (CME56-100)
	Xircom CreditCard Modem 56 (CM-56G)
	3Com 56K Modem (3CCM156)
	3Com 56K Modem (3CXM756)
	GVC 56K Modem (VF-1156PV/C3)
	LAN Card:



Item	Specifications
	D-Link Fast Ethernet DFE-650
	D-Link CardBus DE-660
	3COM 10/100 16Bit LAN Card (3CCFE574BT)
	3COM(DELL) 10/100 BAST-TX LAN Card (3CCFE575BT-D)
	3COM 10/100 CardBus LAN Card (3CCFE575CT)
	3COM 10M LAN Card (3CCE589ET)
	Xircom CreditCard Ethernet 10/100 (CE3B-100)
	Xircom CardBus Ethernet II 10/100 (CBE2-100)/32bit
	Pci_ Fast Ethernet Card FNW-3602-TX
	SCSI
	Adaptec SlimSCSI APA-1450A Card
	Adaptec SlimSCSI APA-1460D Card
	Adaptec SlimSCSI 1480A CardBus UltraSCSI Card
	LAN + Modem Card:
	3COM 10/100 LAN+56k Modem Card (3CXFEM656C)
	Xircom CreditCard Ethernet + Modem 56k (CEM56-100)
	ATA Card:
	KingMax 40MB
	Compact Flash 96MB
	IBM Microdrives 340MB
	PCMCIA IDE/ATAPI Controller
	FLASH/32MB
	IOMEGA Click! PC CARD DRIVE
	Passport CardBus + HDD
	Travel HDD 3.2GB + Passport CardBus /ACCURITE
	IEEE 1394 CardBus Card
	Compag 1394 CardBus Card
	Billionton 1394 CardBus Card
	VST Fire Wire 1394 CardBus Card
	Wireless LAN Card:
	Gemtek Wireless LAN Card
	COMPAQ Wireless LAN Card
	Bluetooth Card:
	3Com Bluetooth Card(3CRWB6096)
	MMC Card
	Apacer 64MB
	MS Card
	Sony 64MB
	Apacer 128MB
	SD Card
	Apacer 128MB
	SM Card
	Apacer 64MB
	SunDisk 128MB
	CF Card

Item	Specifications
	Canon FC-16M
	Apacer 128MB
	Pantex 128MB
	SunDisk 10MB
USB PORT	USB Mouse:
	Microsoft Optical USB Mouse
	TARGUS Wheel Mouse
	Logitech Wheel Mouse
	Acer USB Mouse M012B0
	USB Keyboard:
	Microsoft Internet Keyboard Pro
	Gateway Keyboard SK-9910U
	Gateway Keyboard SK-9926
	SILITEK K/B
	USB Camera:
	Dlink DSC 350
	Dlink DSB-C300
	USB HDD:
	Argosy HDD
	Ennyah
	IEEE 1394 (Fire Wire)/USB 1.1 Combo Hard Drive\FUJITSU MHS2030AT
	USB CD-ROM:
	IOMega ZIP CD650
	USB CDR/W :
	YAMAHA CRW-70
	PHILIPS JR24CDRW/17
	USB Printer:
	HP DeskJet 930C
	HP DeskJet 840C
	USB FDD:
	MIC USB FDD YD-8U10
	Logitec USB FDD
	Teac USB FDD
	Y-E Data USB FDD
	Sharp USB FDD
	USB LAN:
	NEC C&C-15R1
	Billionton USB-10/100 FastEthernet USB-100B
	LINKSYS USB LAN
	USB Zip:
	Iomega USB ZIP 250
	USB Scanner:
	HP ScanJet 4100C
	USB HUB:
	PCI USB HUB

Item	Specifications
	XeXtreme USB HUB
	General purpose USB Hub /UH-9124
	USB Gamepad:
	Microsoft Sidewinder Gamepad
	Logitech WingMan GAMEPAD EXTREME
	USB CCD:
	Intel USB CCD /CS430
	Dlink DSC 350 USB CCD
	Logitech QuickCam Home PC Video Camera
	USB Speaker
	Phillip DSS330
	USB Modem:
	V.90 56Kbps Fax/Modem / JATON
	USB Card Reader:
	DATAFAB 5 in 1
	USB Flash Memory:
	Apacer 128MB
AUDIO JACKS	JS-100 Jazz 3D Speaker
	J-S 3D Speaker /J-2201W
	J-S 3D Speaker /J-2202
	SANYO 3D Speaker
	SONY Earphone MDR-CD60
	Panasonic Earphone RP-H1254
	Philips Earphone
MIC.	Condenser MIC. EM-420T
	Dynamic MIC.
Game	Harry Potter
	Diablo II
	Quake III
	World of Warcraft II
Access Point	Intel Access Point
S/W	Microsoft Office 2K
	Microsoft Office XP
	Microsoft Project 2000(TW)
	Lotus Notes 4.6
	WinFax10.0
	Adobe Acrobat 5.0
	Microsoft FrontPage2002
Bluetooth	Bluetooth PDA: Fujitsu SIMEMS PAD Pocket L00X
	Buletooth mobile phone: Sony Ericsson
Port Replicato	Acer Port Replicator



## Online Support Information

---

This section describes online technical support services available to help you repair your Acer Systems.

If you are a distributor, dealer, ASP or TPM, please refer your technical queries to your local Acer branch office. Acer Branch Offices and Regional Business Units may access our website. However some information sources will require a user i.d. and password. These can be obtained directly from Acer CSD Taiwan.

Acer's Website offers you convenient and valuable support resources whenever you need them.

In the Technical Information section you can download information on all of Acer's Notebook, Desktop and Server models including:

- Service guides for all models
- User's manuals
- Training materials
- Bios updates
- Software utilities
- Schematics
- Spare parts lists
- Chips
- TABs (Technical Announcement Bulletin)

The service repair section provides you with downloadable information on:

- Troubleshooting guides
- Tooling box information
- Repair instructions for specific models
- Basic repair guidelines
- Debug cards for Acer's latest models

For these purposes, we have included an Acrobat File to facilitate the problem-free downloading of our technical material.

Also contained on this website are:

- Detailed information on Acer's International Traveler's Warranty (ITW)
- Returned material authorization procedures
- An overview of all the support services we offer, accompanied by a list of telephone, fax and email contacts for all your technical queries.

We are always looking for ways to optimize and improve our services, so if you have any suggestions or comments, please do not hesitate to communicate these to us.



**A**

AC Adapter 28  
ACPI 1.0a 22  
AFLASH Utility 44  
Audio 25, 26

**B**

Battery 27  
Battery Pack 51  
BIOS 22  
    package 22  
    password control 22  
    ROM size 22  
    ROM type 22  
    vendor 22  
    Version 22  
BIOS Setup Utility 33  
BIOS Supports protocol 22  
BIOS Utility 33—??  
    Basic System Settings 38  
    Navigating 34  
    Onboard Device Configuration 40  
    Startup Configuration 39  
    System Information 34  
    System Security 43  
Board Layout 4  
    Bottom View 5  
    Top View 4

**C**

Cache  
    controller 22  
    size 22  
caps lock  
    on indicator 12  
Core logic 26  
CPU  
    core voltage 22  
    package 22  
    type 22

**D**

DIMM 22  
    Combinations 23  
    external 52  
    package 22  
    removing 52  
    Speed 22  
    voltage 22  
Disassembly  
    Battery Pack 50  
    Machine 47  
    Procedure Flowchart 49  
Display 3  
DVD-ROM Interface 24

**E**

Error Symptom-to-Spare Part Index 69  
External CD-ROM Drive Check 64

**F**

Features 1  
features 97  
Flash Utility 44  
FRU (Field Replaceable Unit) List 79

**H**

Hard disk 23, 26  
HDD 23, 26  
Hot Keys 13

**I**

Indicators 12  
Intermittent Problems 75

**K**

Keyboard 26  
Keyboard or Auxiliary Input Device Check 65

**L**

L2 cache 22

LAN/Modem Combo 23

## M

Machine Disassembly 47

Memory Check 65

Model Definition 96

Modem 23

## N

num lock  
on indicator 12

## O

Online Support Information 109

## P

Panel 6

Bottom 11  
left 6  
Rear 9  
right 9

Parallel Port 25

PC Card 12

Power System Check

Battery Pack 67  
Power Adapter 66, 67

Processor 22

## R

RMA 79

RTC 26

## S

Second Level Cache 22

Super I/O 26

System

Block Diagram 3  
Layout 4

System Check Procedures 64

System Memory 22

System Specifications 1

Features 97

System Utilities 33, 79

## T

Temperature 29

Test Compatible Components 99

Touchpad Check 67

Troubleshooting 63

## U

Undetermined Problems 76

utility  
BIOS 33-??

## V

Video 25

Resolutions 25

Video controller 26

## W

Windows 2000 Environment Test 100



